

MEF

A faint, dark blue world map is visible in the background, centered behind the text.

Optimizing Mobile Backhaul

MEF Reference Presentation
October 2011

MEF Reference Presentations

- **Intention**

- These MEF reference presentations are intended to give general overviews of the MEF work and have been approved by the MEF Marketing Committee
- Further details on the topic are to be found in related specifications, technical overviews, white papers in the MEF public site Information Center:
<http://metroethernetforum.org/InformationCenter>

- **Notice**

© The Metro Ethernet Forum 2011.

Any reproduction of this document, or any portion thereof, shall contain the following statement: "Reproduced with permission of the Metro Ethernet Forum." No user of this document is authorized to modify any of the information contained herein. See also MEF Terms of use at http://metroethernetforum.org/page_loader.php?p_id=501

Mobile Backhaul Topics

- **Market Impact of Carrier Ethernet for Mobile Backhaul**

- Market Data and Drivers
- MEF 22 – Mobile Backhaul Implementation Agreement Phase I

- **New Work**

- Carrier Ethernet for MBH: 2011-2014
- Work in progress supporting 4G (MBH IA Phase II)
- Carrier Ethernet Multiple Classes of Service in the Mobile Backhaul
 - Optimizing the Backhaul
- Synchronization for Mobile Backhaul
 - A New MEF Paper

- **Addendum: Migration from Legacy Transport**

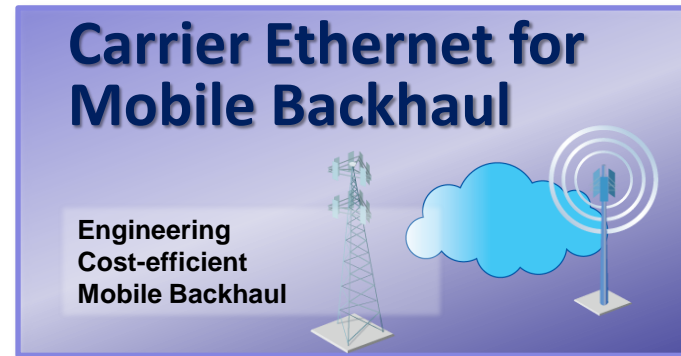

Two Implementations of Carrier Ethernet

Context for this Presentation

Application of Carrier Ethernet for Mobile Backhaul Network

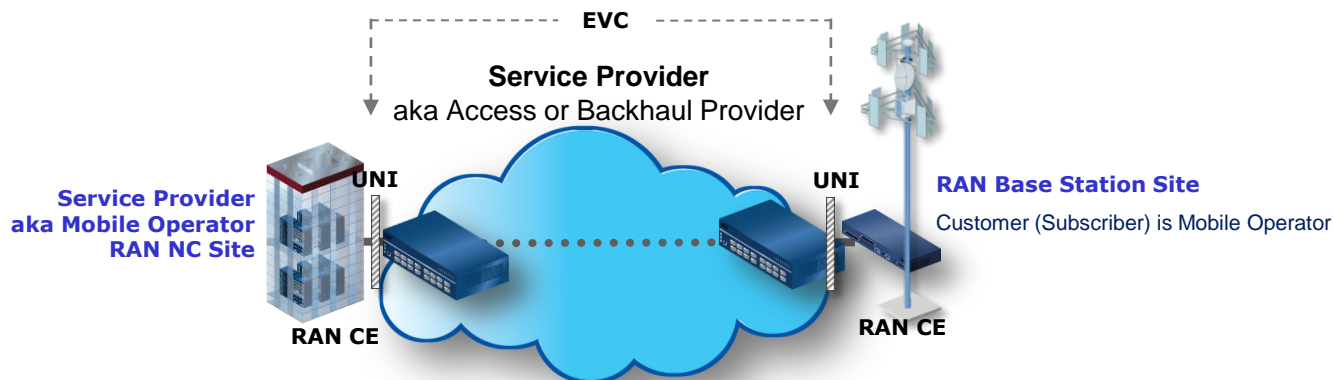

Application of Carrier Ethernet for End-to-End Carrier Ethernet Network Service Delivery

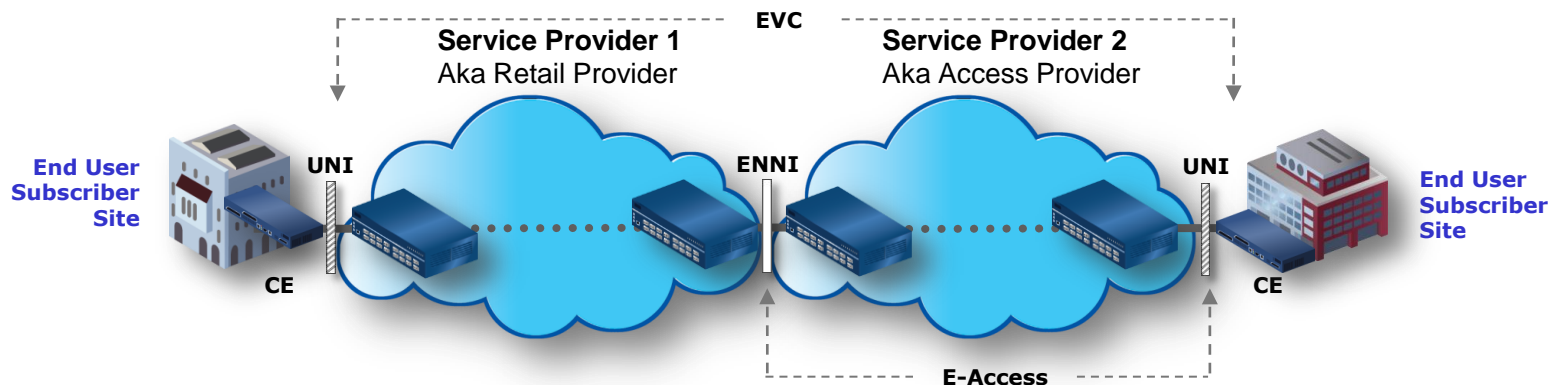

* Full details in MEF Mobile Backhaul Reference Presentation

Mobile Backhaul Market Scorecard

- **IP/Ethernet mobile backhaul (MBH) is the universally accepted solution to lower the costs of growing mobile data traffic, include IP/Ethernet in the 3G transition, and use IP as the basic technology of LTE and WiMAX**
- **The momentum is growing no matter how it is measured:**

89% of 2010 mobile backhaul equipment spending was for IP/Ethernet

79% of operators have a strategy to move to single all-IP/Ethernet backhaul

Timing/synchronization is no longer a barrier

150 mobile operators are now actively deploying IP/Ethernet backhaul

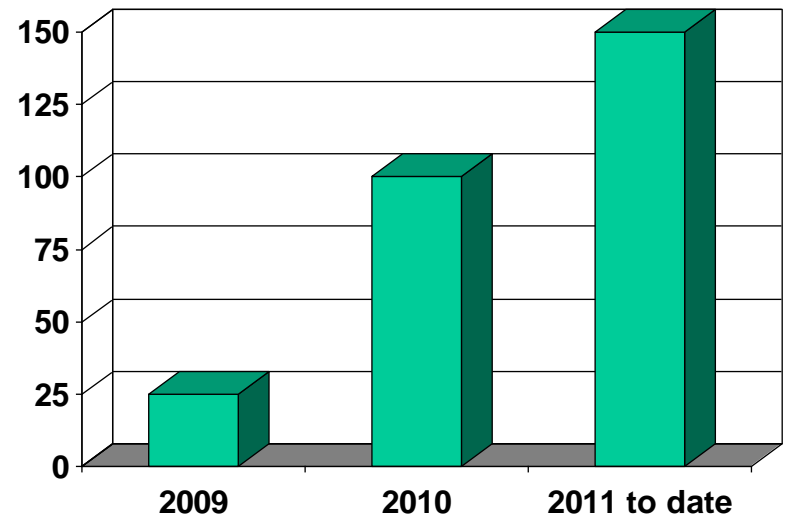

Source: Infonetics Research, Mobile Backhaul Equipment and Services Biannual Market Size, Share, and Forecast, April 2011

MBH 2008-2010: Why MBH Went Ethernet

The 2008 - 2010 story

- Mobile bandwidth is growing exponentially – but revenues are not

Carrier Ethernet for Mobile Backhaul

- Ethernet offers significantly lower cost/bit
- Ethernet is ubiquitous, simple and flexible
- Ethernet opens up wholesale opportunities

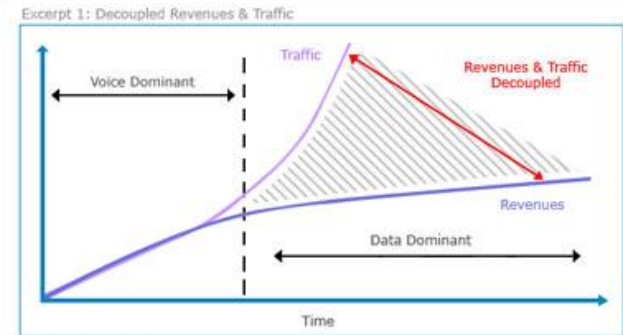

“Ethernet is seen as the only solution for next generation MBH networks ... legacy technology can’t scale ... “



*Michael Howard,
principal analyst
at Infonetics
Research*

MEF



MEF 22 – Mobile Backhaul Implementation Agreement

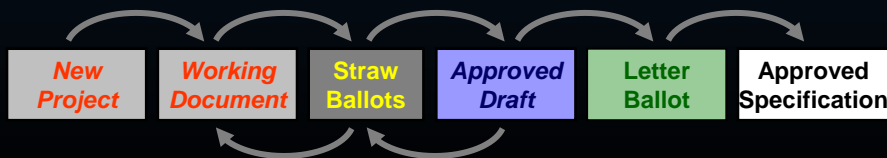

MEF 22: Overview

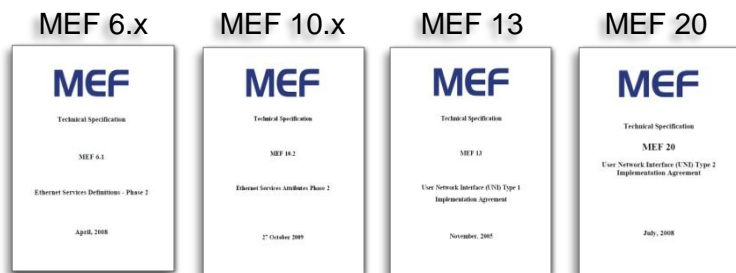

MEFs own work as the foundation

Other SDOs



Industry trends

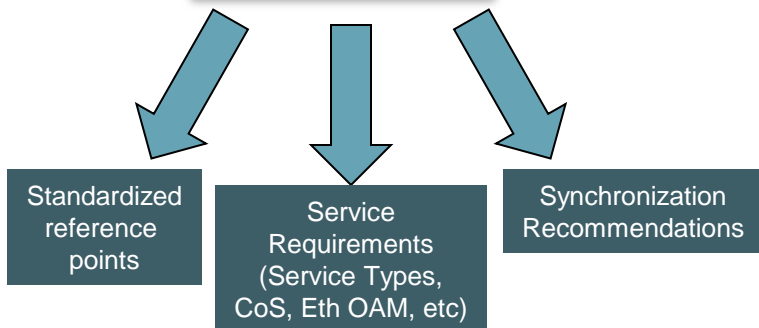

MEF 22 Terminology and Concepts

- Functional Elements as defined in MEF 22 Specification

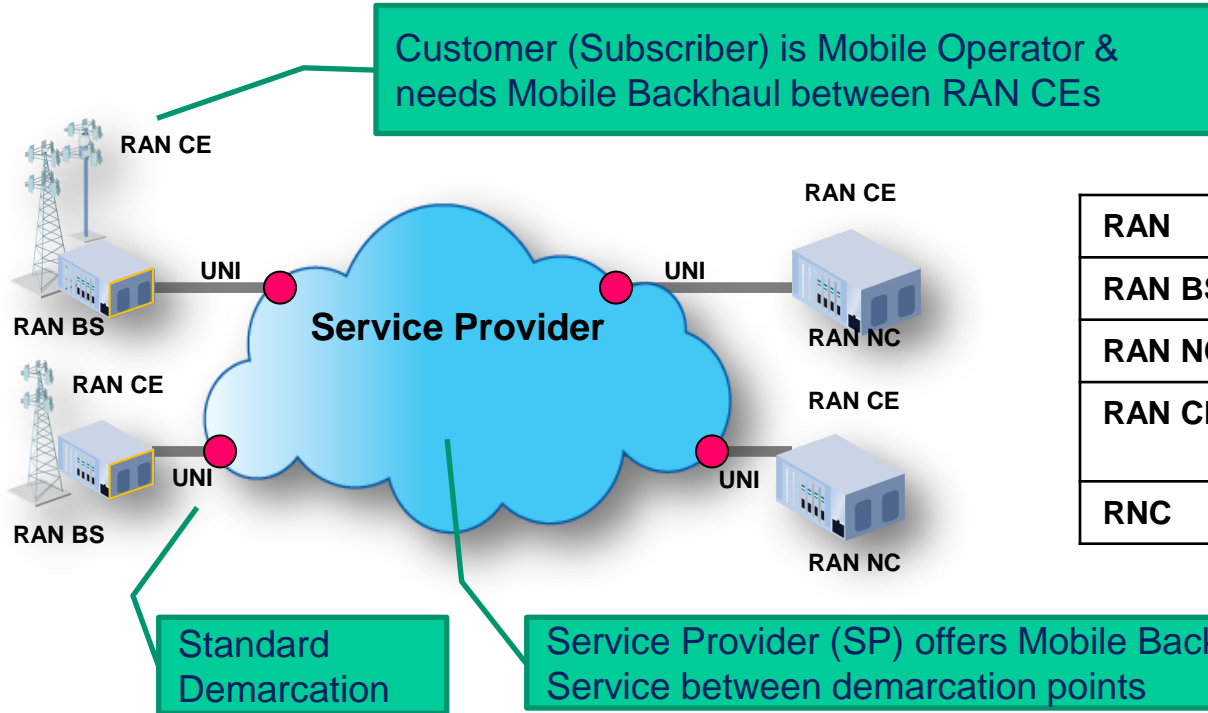

RAN	Radio Access Network
RAN BS	RAN Base Station
RAN NC	RAN Network Controller
RAN CE	RAN Customer Edge –Mobile network node/site
RNC	Radio Network Controller

Carrier Ethernet Mobile Backhaul Service

- Standard Demarcation
- Standard & Scalable Services with Quality of Service
- Service Management & Reliability

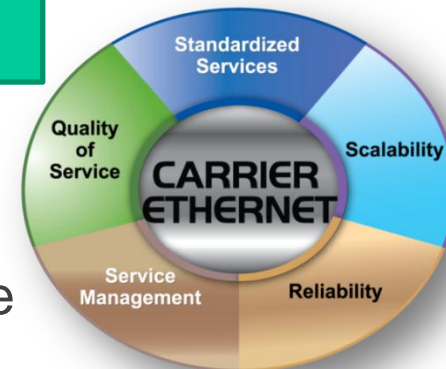

MEF Services over multiple Access Technologies

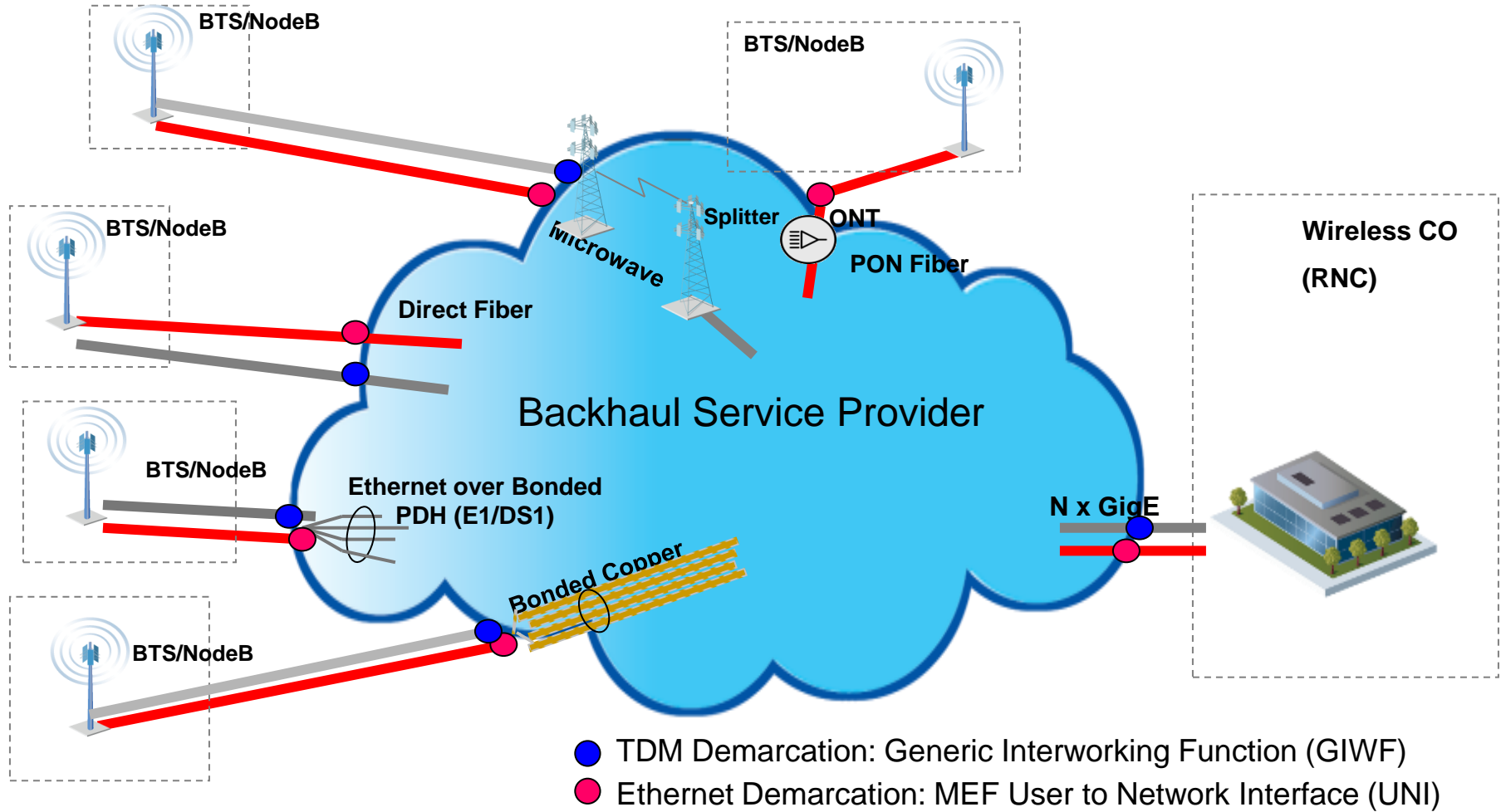

MEF

A dark blue world map is centered in the background of the slide, showing the outlines of continents and countries. The map is semi-transparent and serves as a backdrop for the text.

New MEF Work

MBH 2011-2014: Optimizing the Backhaul

Ethernet has been adopted: there are new challenges

- **4G/LTE**
 - MEF providing necessary attributes required: MEF 22.1
 - Enhanced Service Attributes
- **Single Class of Service causes very costly overbuild**
 - Initial and Current deployment dominated by inefficient single class of service implementation
 - MEF providing specifications and guidance for deploying multiple classes of service
- **Help with best Practices for Synchronization**
 - New MEF paper available October 2011
- **Total Impact of new MEF work**
 - Efficient, profitable and scalable deployment for Mobile Operators Access Providers

Mobile Backhaul Service for LTE

- **3G Backhaul: ~ 100km (Metro)**

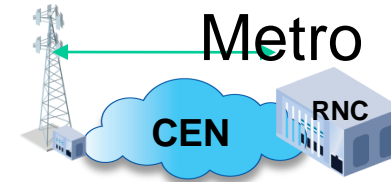

- **LTE Backhaul:**

- BS to S-GW/MME ~1000km (Regional)
- BS to BS ~ neighbors (10s of km)

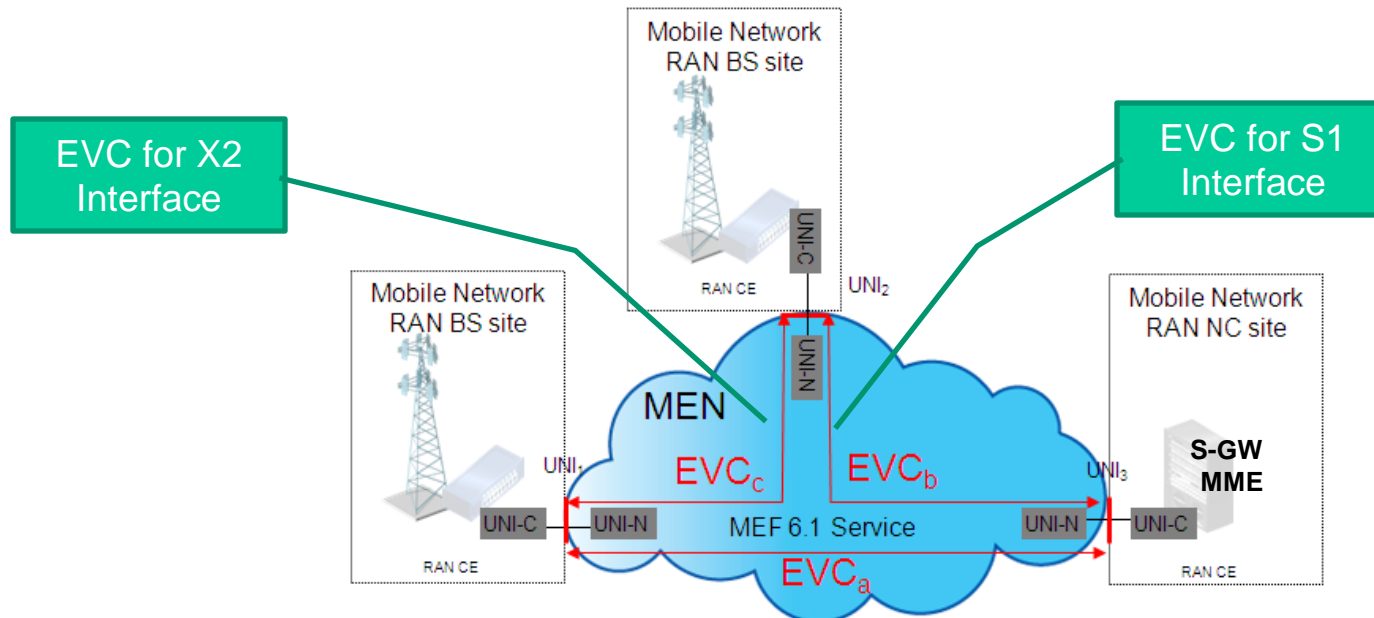
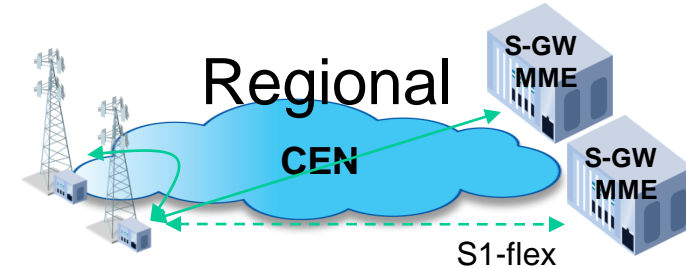

MEF



Enhanced Service Attributes for Mobile Backhaul

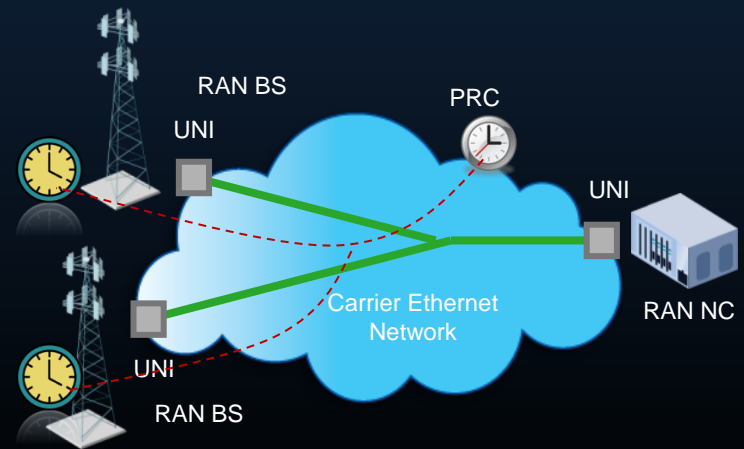

Enhancements: Service Class for sync traffic

- **Using Service Frames in the EVC**

- Frame arrival rate with Adaptive Clock Recovery (ACR)
 - Stringent performance, e.g. Frame Delay Range
- Can also use CES RTP optional header for synchronization timestamps

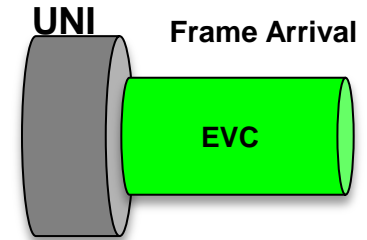

- **Using a control protocol (e.g. IEEE1588v2)**

- Separate Class of Service with stringent performance, if needed

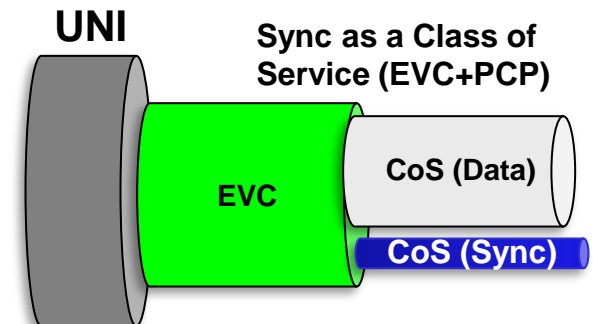
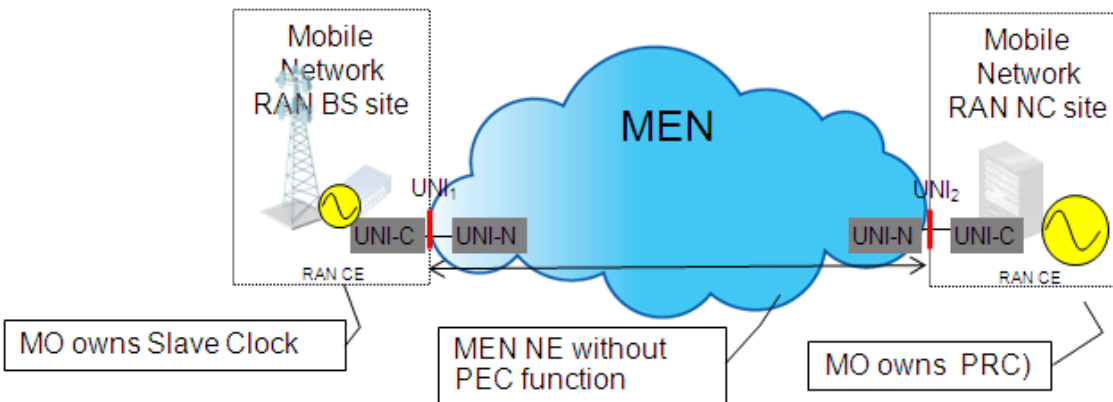
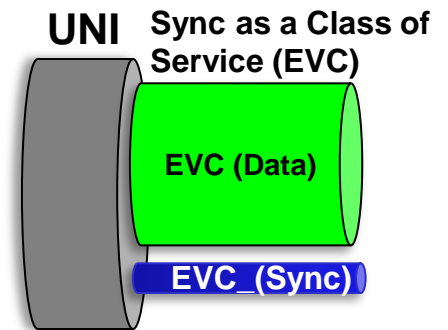

MO: Mobile Operator
 NE: Network Element
 PEC: Packet Equipment Clock
 PRC: Primary Reference Clock
 PCP: Priority Code Point

Enhancements: UNI Mode Attribute

- **UNI PHY**
 - Synchronous mode of operation (Synchronous Ethernet)
 - Locked to Ethernet Equipment Clock (EEC)
- **Interoperable operation of Synchronous Ethernet**
 - Synchronous messages: Generation & processing rules
 - Clock Quality Level (QL) indication & processing rules
 - Direction of clock distribution: MEN to Base Station
- **Recommendation to support QL processing in Base Station**
 - Failure conditions & Switchover to alternate Primary reference

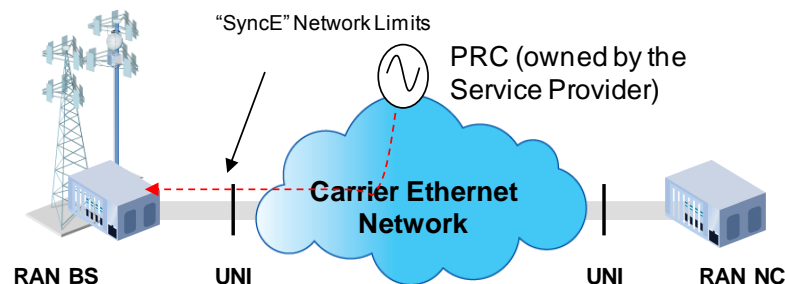

Enhancements: Resiliency Performance

- Resiliency Performance depends on both UNI and EVC
- UNI Resiliency with Link Aggregation (UNI Type 2)
- Diversity for higher Availability
 - MEN Resiliency Model vs RAN Resiliency Model
 - Partial vs Full Diversity
 - Use Case: S1-flex in LTE
 - Use Case: Multiple Primary Reference Clocks
- Group Availability: e.g. Set of EVCs

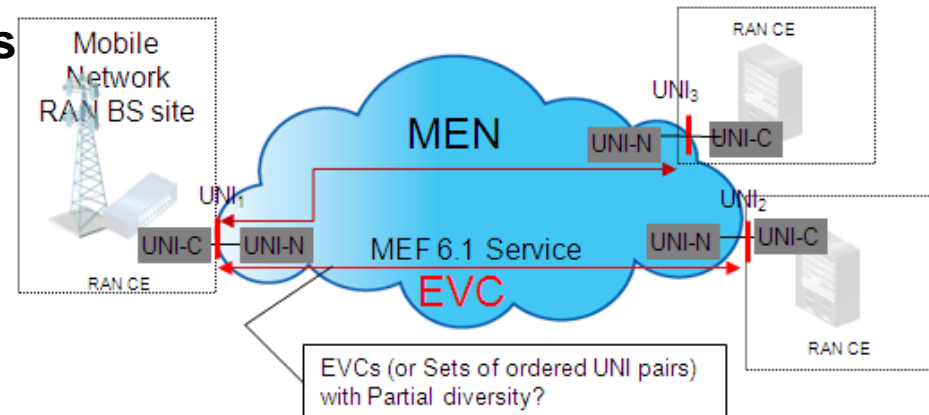

Resiliency/Protection

- **MEF Service Specifications augment industry standards**
- **In totality, they address port and service protection, fault detection and restoration**
 - At the UNI ports
 - At the ENNI (for direct and Exchange connections)
 - For UNI to UNI (EVCs)
 - UNI-ENNI OVCs

Protection
✓ 1+1 APS
✓ LAG (802.1ax LACP)
✓ Dual Homing
✓ Ring (G.8032)
✓ Linear Protection (G.8031)

- **The following is one option for Mobile Backhaul showing Active/Standby**

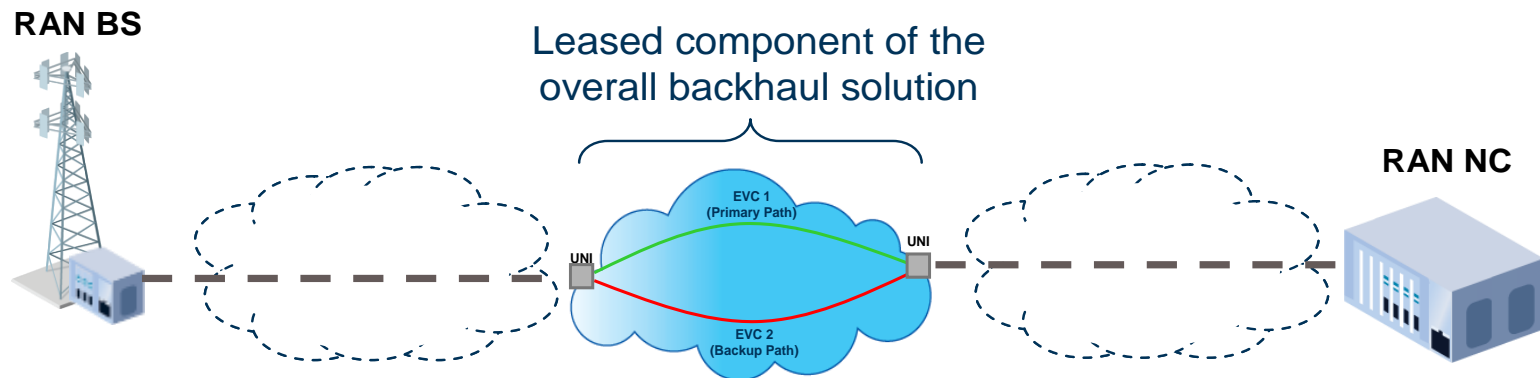

Enhancements: Class of Service Mapping

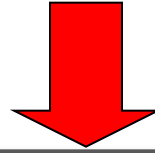

CoS Name	Example of Generic Traffic Classes mapping into CoS		
	4 CoS Model	3 CoS Model	2 CoS Model
Very High (H+)	Synchronization	-	-
High (H)	Conversational, Signaling and Control	Conversational and Synchronization, Signaling and Control	Conversational and Synchronization, Signaling and Control, Streaming
Medium (M)	Streaming	Streaming	-
Low (L)	Interactive and Background	Interactive and Background	Interactive and Background

Value to Mobile Operator: Know what performance each 3GPP traffic class will get

Value to MEN Operator: Standard CoS offering with default performance objectives

Enhancements: Performance objectives

Performance Attributes one-way	CoS Label H		CoS Label M		CoS Label L ¹		Applicability
	Pt-Pt	Multipoint	Pt-Pt	Multipoint	Pt-Pt	Multipoint	
FD (ms)	≤ 10	TBD	≤ 20	TBD	≤ 37	TBD	At least one of either FD or MFD required
MFD (ms)	≤ 7	TBD	≤ 13	TBD	≤ 28	TBD	
IFDV (ms)	≤ 3	TBD	≤ 8 or N/S ²	TBD	N/S	TBD	At least one of either FDR or IFDV required
FDR (ms)	≤ 5	TBD	≤ 10 or N/S ²	TBD	N/S	TBD	
FLR (ratio)	≤ .01% i.e. 10 ⁻⁴	TBD	≤ .01% i.e. 10 ⁻⁴	TBD	≤ .1% i.e. 10 ⁻³	TBD	
Availability	TBD	TBD	TBD	TBD	TBD	TBD	

[Reference: CoS IA Ph2] Performance Tier 1 (Metro) CoS Performance Objectives

Note:

- Performance Tier 2 (regional) is also applicable for Mobile Backhaul
- Performance Objective for H⁺ Class is work in progress

Enhancements: Service Management

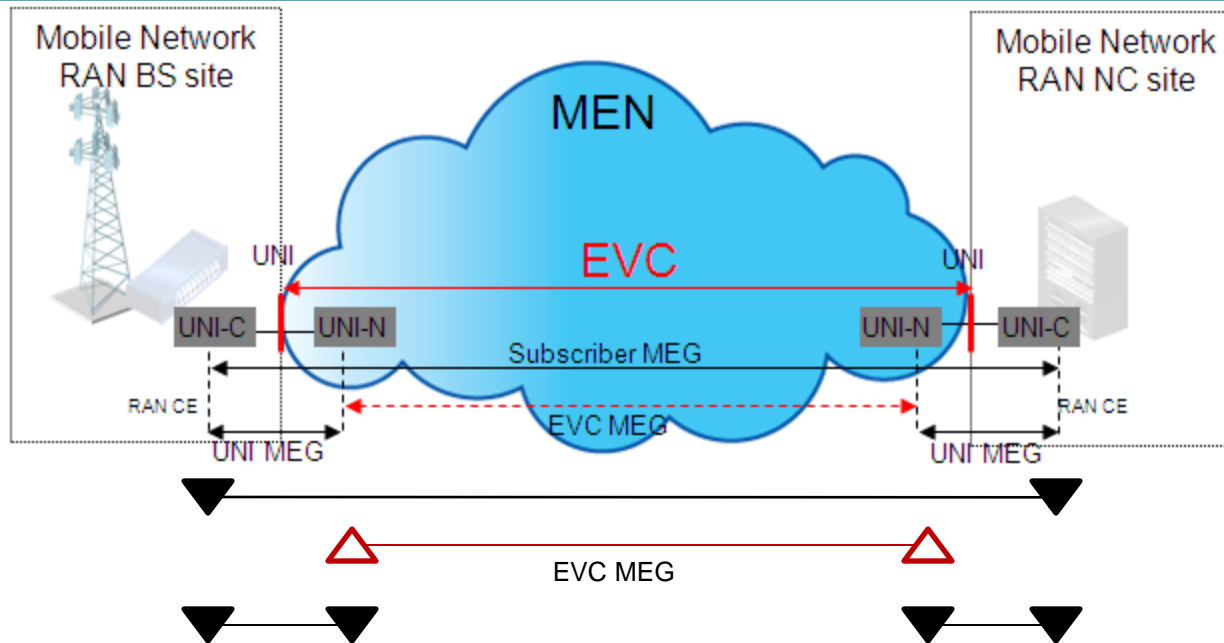

- **Subscriber MEG for Mobile Operator (as Customer/Subscriber)**
- **EVC MEG (or Operator MEG) for MEN Operator (as Service Provider)**
 - Fault and Performance Management to report EVC Performance
- **UNI MEG used to monitor MEF compliant UNI**
 - e.g.. RAN CE & MEN using UNI Type 2 with Service OAM capability

Enhancements: Resiliency Performance

- Resiliency Performance depends on both UNI and EVC
- UNI Resiliency with Link Aggregation (UNI Type 2)
- Diversity for higher Availability
 - MEN Resiliency Model vs RAN Resiliency Model
 - Partial vs Full Diversity
 - Use Case: S1-flex in LTE
 - Use Case: Multiple Primary Reference Clocks
- Group Availability: e.g.. Set of EVCs

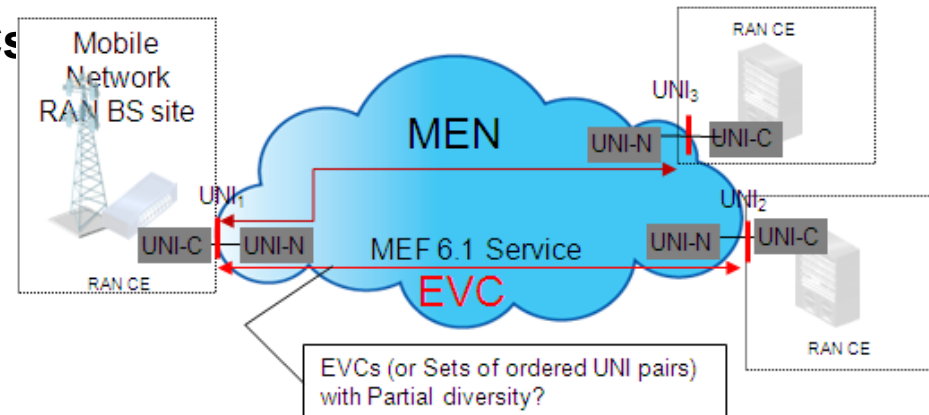

Enhancements: Resiliency Performance

- **Long term disruptions**
 - EVC Performance attribute: Availability
 - Example: performance over a month
- **Short term disruptions (1 or more Δt intervals)**
 - EVC Performance attribute: High Loss Interval (HLI) count
 - similar to Severely Errored Seconds (SES) in SONET/SDH
 - Why: 1-2s loss in signaling can bring down a cell site

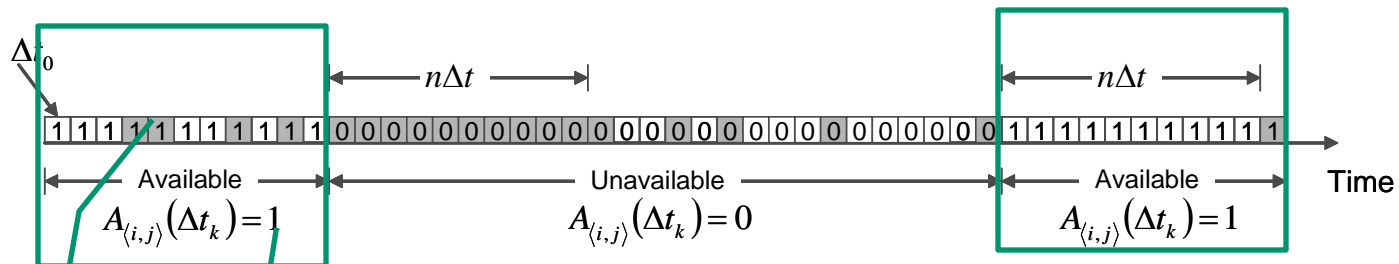

$n = 10$

■ $flr_{\langle i,j \rangle}(\Delta t_m) > C$

□ $flr_{\langle i,j \rangle}(\Delta t_m) \leq C$

Reference: MEF 10.2.1

MEF 22 Scope Comparison

ITEM	PHASE 1	PHASE 2
UNI	✓	✓
Service Types	✓	✓
Link OAM	✓	✓
Service OAM FM	✓	✓
Service OAM PM		✓
CoS	✓	✓
Performance recommendations		✓
Packet based sync	✓	✓
SyncE		✓
Resiliency Performance		✓
GSM, WCDMA, CDMA2000, WiMAX 802.16e	✓	✓
LTE		✓

A few key Service Attributes

- **UNI Type (MEF 13 & 20)**
- **UNI Service Attributes (MEF 10.2, MEF 6.1)**
 - Mode: Asynchronous Full Duplex
 - >1 EVC & capability to support max # of EVCs
 - Bandwidth profiles per UNI
- **EVC per UNI Service Attributes (MEF 10.2, MEF 6.1)**
 - EVC Classification: CE-VLAN ID to EVC Map
 - Bandwidth profiles per EVC
- **EVC Service Attributes (MEF 10.2, MEF 6.1, MEF 23)**
 - EVC Type and UNI List with Type (Root or Leaf)
 - CE-VLAN and Class of Service (CoS) preservation
 - EVC Performance per CoS ID for one or more Classes of Service



MEF

Optimizing Mobile Backhaul

Carrier Ethernet with Multiple Classes
of Service

Delivering Bandwidth Required for 4G/LTE

- According to all wireless operators, delivering the bandwidth required in the 4G-LTE wireless backhaul is *“the single biggest challenge and operating cost in the industry.”*
- **Carrier Ethernet with Multiple Classes of Service** represents a breakthrough in sustainable, high-quality, profitable deployment
- **New Work from the MEF provides**
 - Two MEF technical specifications in Jan 2012 time frame
 - Mobile Backhaul Phase 2
 - Class of Services Phase 2
 - Business and technical education and Implementation guidance

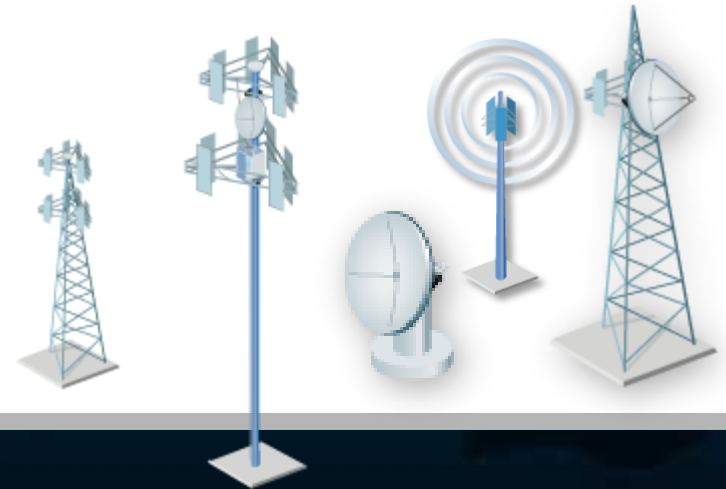

Single Class vs. Multi Classes (1)

All one Class of Service: simple but costly

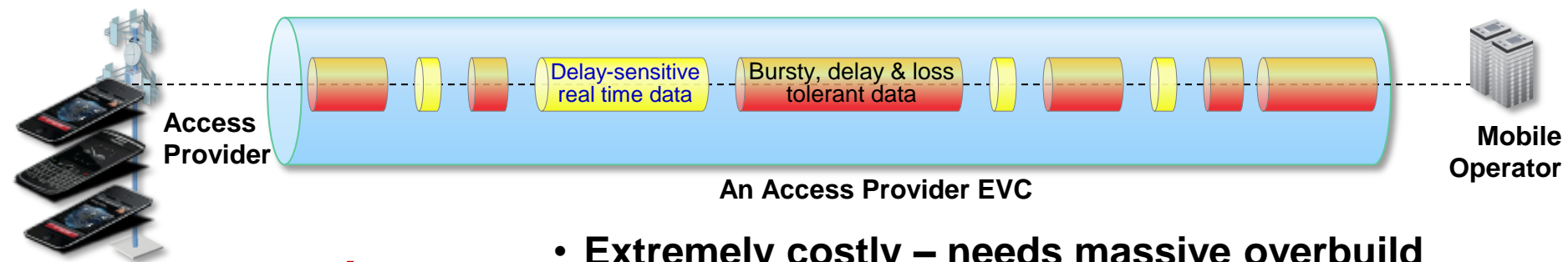

Result/Impact

- Extremely costly – needs massive overbuild
- Does not scale - recipe for going out of business
- High Priority traffic subject to delay – especially during traffic bursts and peaks

Single Class vs. Multiple Classes of Service (2)

Multiple-Classes of Service: more complex but great rewards

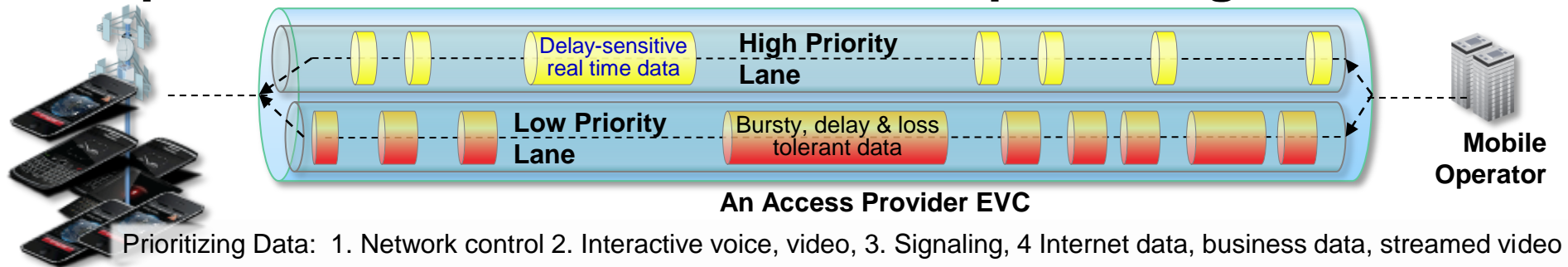

Result/Impact

Backhaul Operators (aka Access Providers)

- More Revenue for same cost: more users supported, more responsive QoS
- Avoids costly over-building network to ensure integrity, QoS
- Squeezes best performance to maximize profitability by leveraging the statistical multiplexing of Ethernet

Mobile Operators:

- Enables resolution of their most critical challenge:

“Handling unprecedented growth of data efficiently while preserving or improving QoS.”

- **MEF**

MEF



Frequency Synchronization for Mobile Backhaul

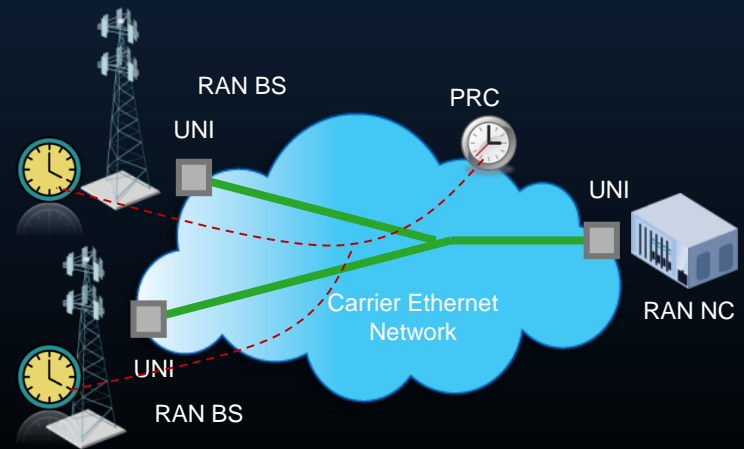

Synchronization Requirements

Frequency Synchronization

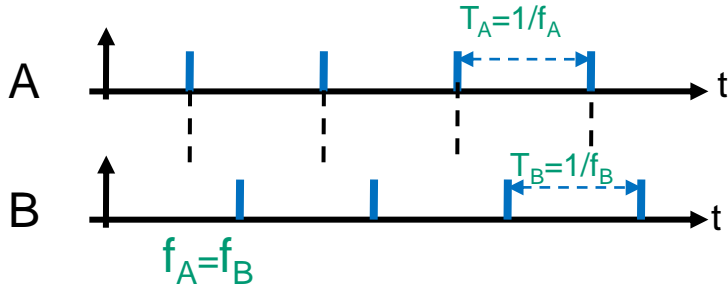

Phase Synchronization

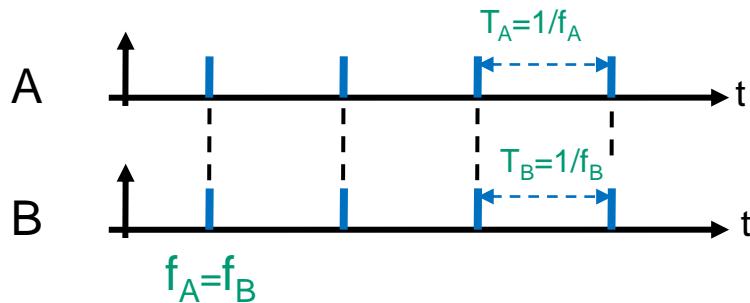

Time Synchronization

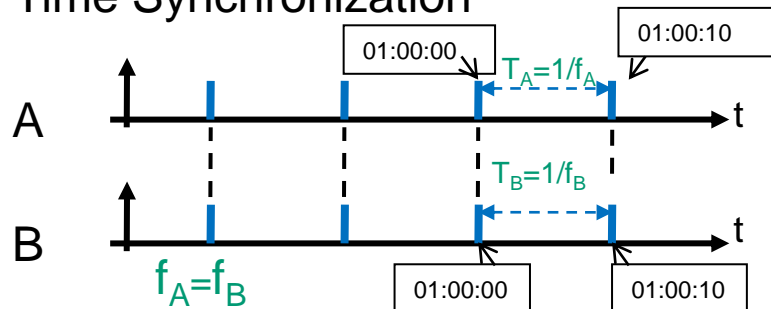

Mobile Network Architecture	Frequency Sync	Time-of-day / Phase Sync
CDMA2000		✓
GSM	✓	
UMTS-FDD	✓	
LTE-FDD	✓	
UMTS-TDD	✓	✓
LTE-FDD with MBMS-Single Freq. Network	✓	✓
LTE-TDD	✓	✓
Mobile WiMAX	✓	✓
TD-SCDMA	✓	✓

Synchronization Distribution Methods

- × Distributed (GPS)

- **Centralized (PRC) and chain of Equipment Clocks (ECs)**

- × Physical Layer (legacy): SONET/SDH Equipment Clock (SEC)

In Scope

- ✓ Physical Layer: Ethernet Equipment Clock (EECs)

- ✓ Packet Equipment Clocks (PECs) with timestamps (1588v2) or frame arrival rate (Adaptive Clock Recovery (ACR))

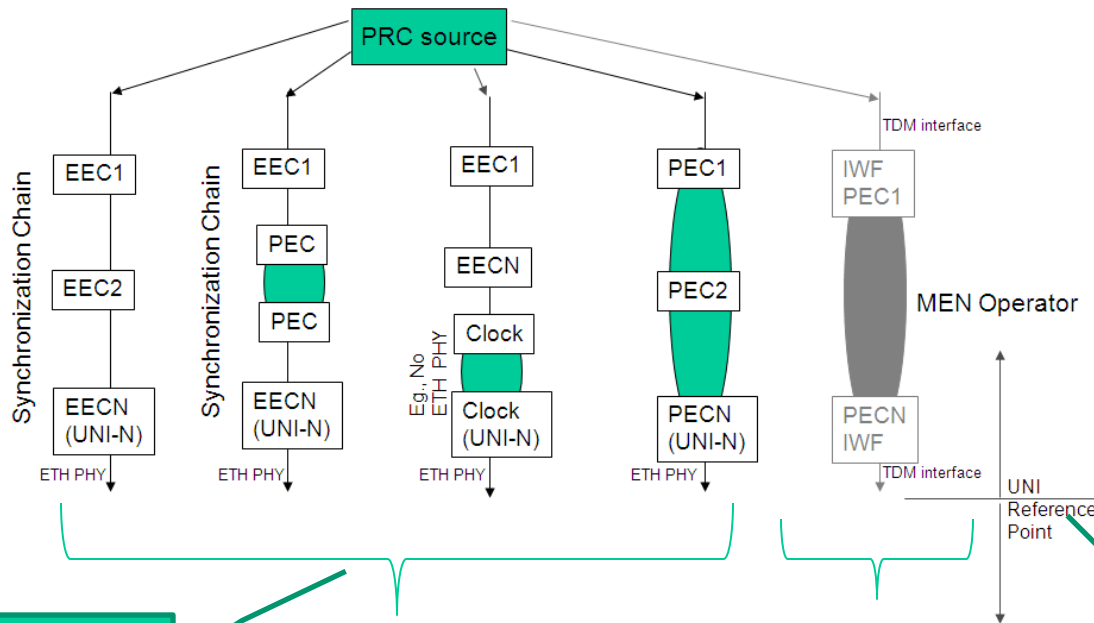

Enhancement of UNI attributes?

For RAN CEs with MEF UNIs (Ethernet)

Legacy RAN CE

Performance: Interface Limits for Jitter & Wander at demarcation

Summary

- **Ethernet has been adopted: there are new challenges**
- **MEF providing solution for optimization**
 - 4G/LTE
 - Carrier Ethernet with Multiple Class of Service
 - Synchronization
- **Total impact of new MEF work**
 - Efficient, profitable and scalable deployment for Mobile Operators Access Providers

MEF



Addendum: Migration from TDM

Although Migration to Ethernet has now been mostly complete, the following slides are retained for completion

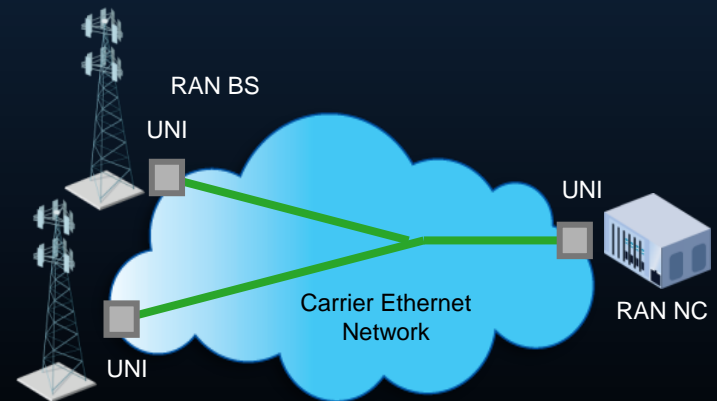

Use Case: Migration to 3G with Ethernet

- Mobile Operator operates 2G and 3G mobile networks
- RAN Base Station Sites with both 2G and 3G radios
- Frequency synchronization required – assume no GPS
- Mobile Operator has TDM leased Lines between BS and NC sites

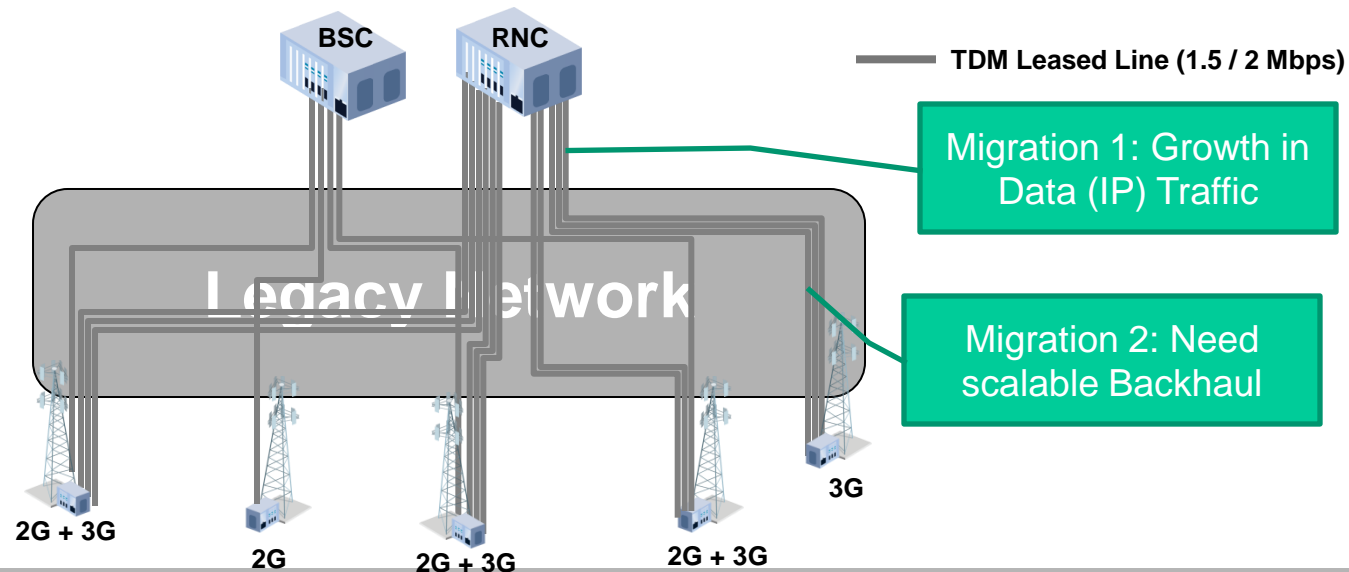

Migration to 3G with Ethernet: Challenges

Problem:

- Capacity increase not cost-effective on TDM Leased Lines

Requirements

- Standard Services
- Manageability
- Reliability
- Quality of Service
- Synchronization

Solution:

- Carrier Ethernet Network
- MEF 8 and 6.x Services

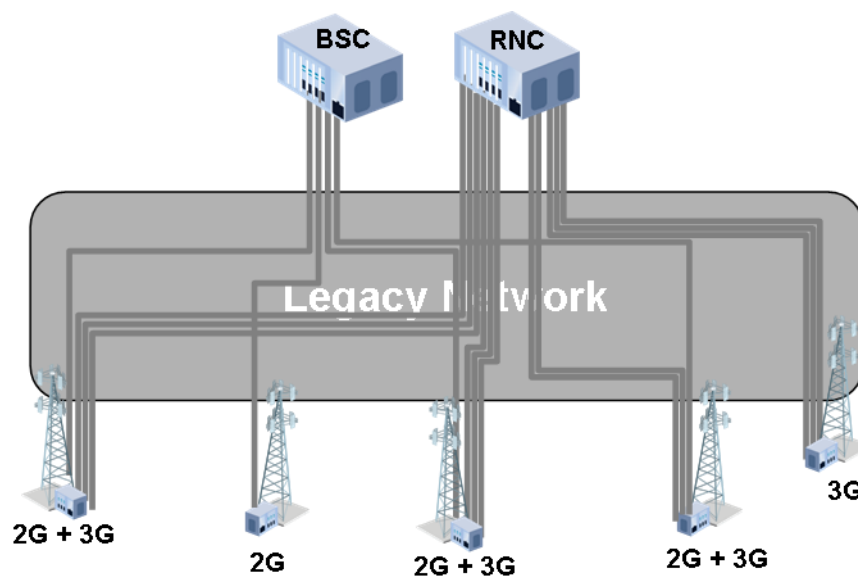

Mobile Backhaul for 2G Legacy RAN

Use Case 1a:
RAN CEs with TDM interfaces

Frequency Synchronization can be with TDM Physical method

Frequency Synchronization can be with ACR/Packet method

Use Case 1b:
RAN CEs with TDM interfaces

All traffic with CES

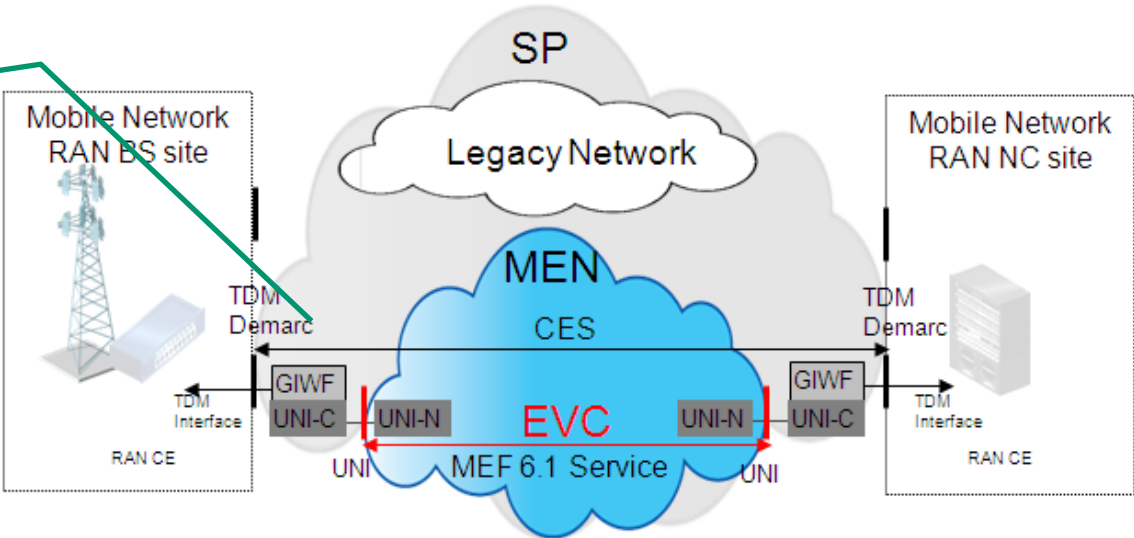
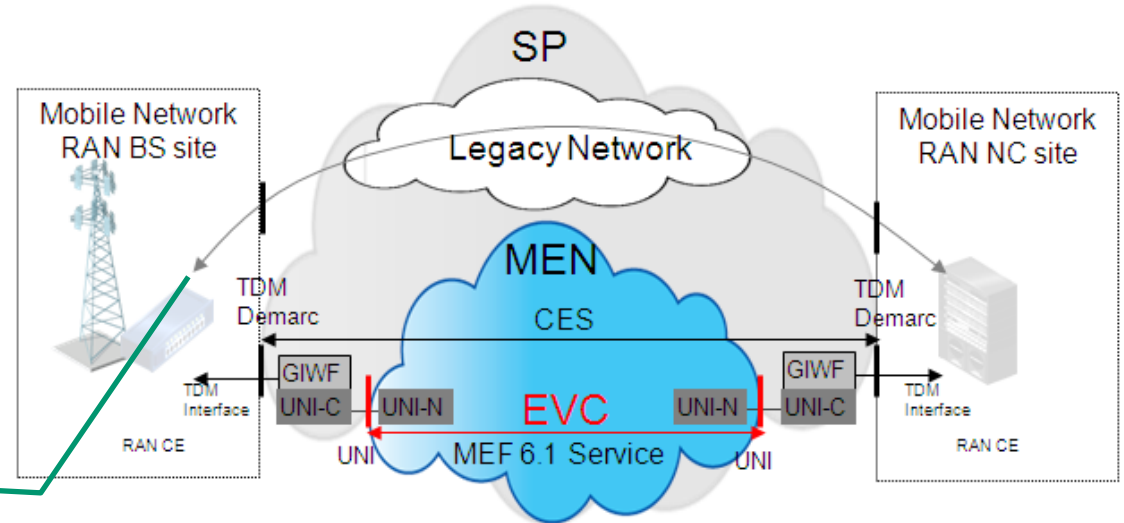

MEF EVC Services to support CES

- **GIWF helps map legacy circuits**
- **ELINE (EPL) between GIWFs**
 - CIR>0, CBS>0 & EIR = 0, EBS=0 for guaranteed bit rate
 - Service Level Specification (SLS) in Service Level Agreement (SLA)
 - Frame Delay, Frame Delay Range, Frame Loss Ratio, Availability

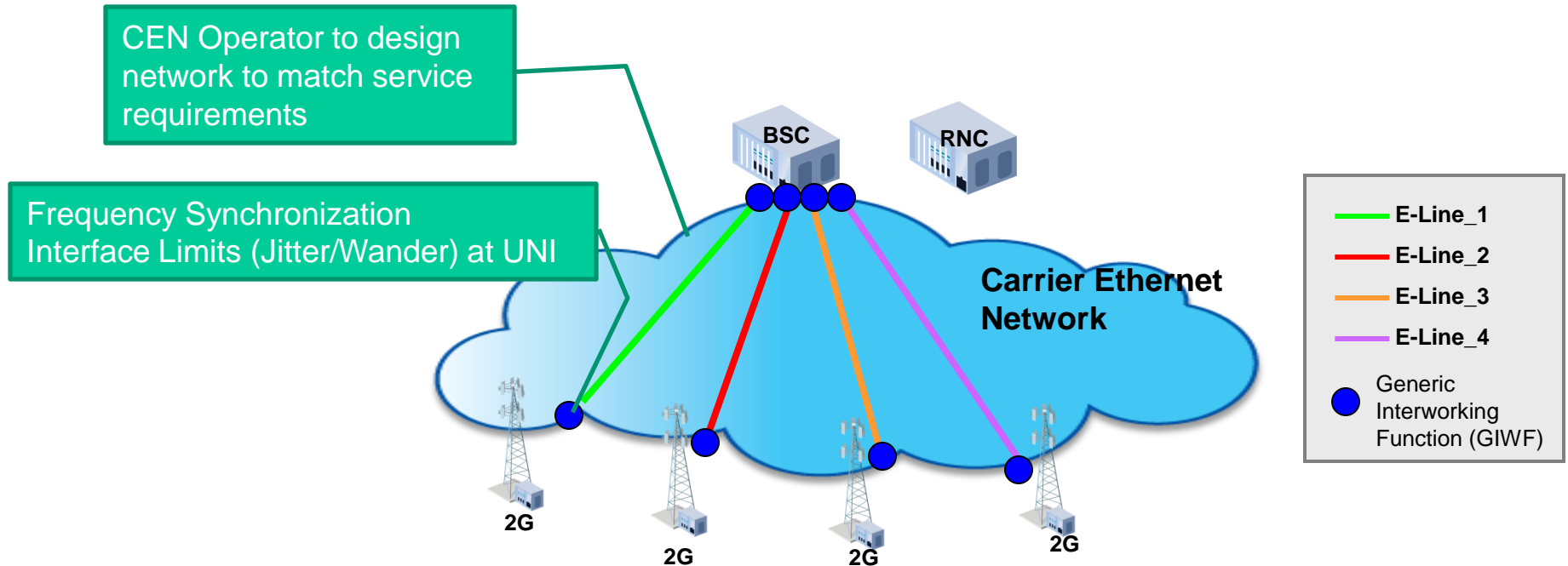

Ethernet RAN Mobile Backhaul Migration

Use Case 2a

RAN CEs with TDM and Ethernet Interfaces

Synchronization can be with TDM

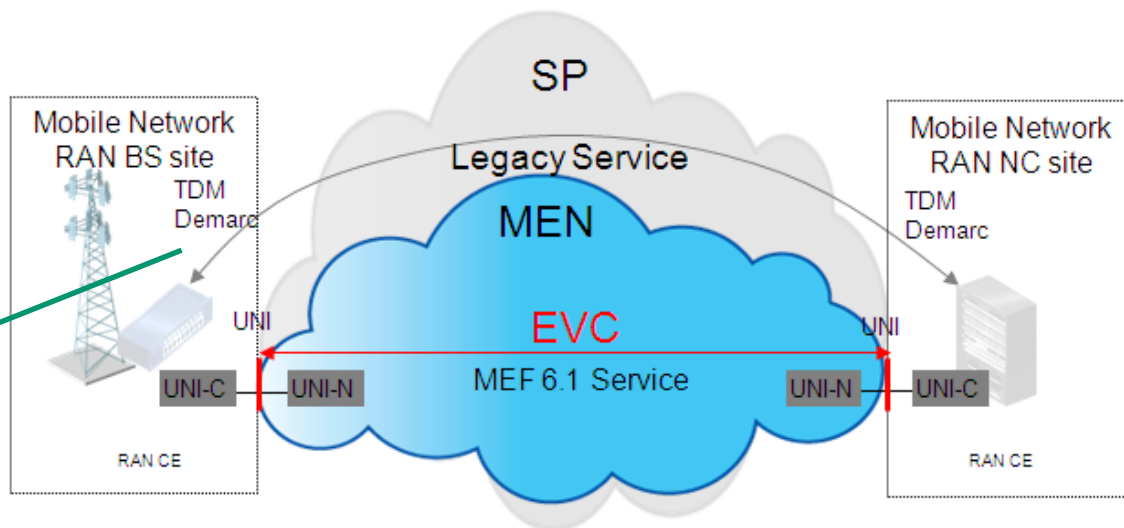

Use Case 2b

RAN CEs with Ethernet Interfaces

Synchronization service from the

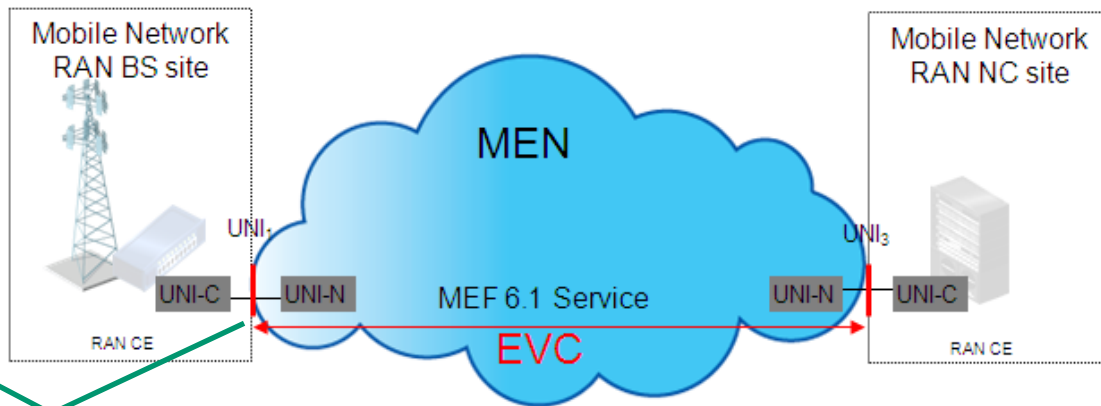

MEF Services for 3G RAN CEs

- **Mobile Operator has MEF Compliant UNIs on RAN CEs**
- **MEN Operator (as Service Provider) has MEF Compliant UNIs**
 - MEF Compliant UNIs for MEF Compliant MEF 6.x services
 - 1 or more Class of Service (CoS), e.g.. 3 CoS
 - Service Level Specification (SLS) in Service Level Agreement (SLA)

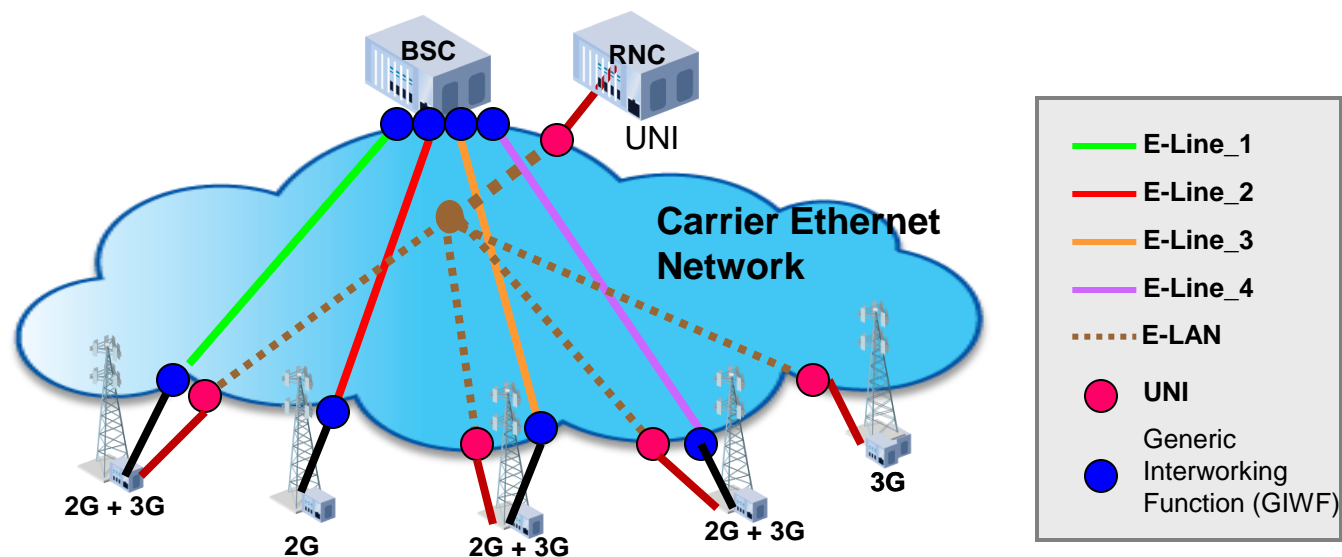

MEF Reference Presentations

MEF Reference Presentations Covering the Principal Work of the MEF

Overview presentation of the MEF.	This presentation gives basic and most up-to-date information about the work of the MEF. It also introduces the definitions, scope and impact of Carrier Ethernet, the MEF Certification programs and describes the benefits of joining the MEF.
Overview presentation of the Technical Work of the MEF	Includes a summary of the specifications of the MEF, structure of the technical committee, work in progress and relationships with other Industry Standards bodies. For PowerPoint overviews of individual specifications: click here
Carrier Ethernet Services Overview	This presentation defines the MEF Ethernet Services that represent the principal attribute of a Carrier Ethernet Network
Carrier Ethernet User-Network Interface	This presentation discusses the market impact of MEF 20: UNI Type 2 Implementation agreement
Carrier Ethernet Access Technology Overview	This presentation describes how the MEF specifications bring Carrier Ethernet services to the world's Access networks (with examples of Active Ethernet (Direct Fiber), WDM Fiber, MSO Networks(COAX and Direct Fiber), Bonded Copper, PON Fiber and TDM (Bonded T1/E1, DS3/E3))
Carrier Ethernet Interconnect Program.	This is the latest presentation from the Carrier Ethernet Interconnect Working Group which acts as a framework for all presentations given on this topic.
Carrier Ethernet OAM & Management Overview	This presentation describes the management framework and the OAM elements for fault and performance management expressed in terms of the life cycle of a Carrier Ethernet circuit
Carrier Ethernet for Mobile Backhaul	A comprehensive marketing and technical overview of the MEF's initiative on Mobile Backhaul that has lead to the adoption of Carrier Ethernet as the technology of choice for 3G and 4G backhaul networks
Carrier Ethernet Business Services	A comprehensive presentation aimed at business users
The MEF Certification Programs	A presentation of the MEFs three certification programs: Equipment, Services and Professionals. These programs have been a cornerstone of the success of Carrier Ethernet and its deployment in more than 100 countries around the world.

MEF

A faint, dark blue world map is visible in the background, centered behind the text.

End of Presentation