

MEF

Technical Specification

MEF 6.2

EVC Ethernet Services Definitions Phase 3

August, 2014

Disclaimer

The information in this publication is freely available for reproduction and use by any recipient and is believed to be accurate as of its publication date. Such information is subject to change without notice and the Metro Ethernet Forum (MEF) is not responsible for any errors. The MEF does not assume responsibility to update or correct any information in this publication. No representation or warranty, expressed or implied, is made by the MEF concerning the completeness, accuracy, or applicability of any information contained herein and no liability of any kind shall be assumed by the MEF as a result of reliance upon such information.

The information contained herein is intended to be used without modification by the recipient or user of this document. The MEF is not responsible or liable for any modifications to this document made by any other party.

The receipt or any use of this document or its contents does not in any way create, by implication or otherwise:

- a) any express or implied license or right to or under any patent, copyright, trademark or trade secret rights held or claimed by any MEF member company which are or may be associated with the ideas, techniques, concepts or expressions contained herein; nor
- b) any warranty or representation that any MEF member companies will announce any product(s) and/or Service(s) related thereto, or if such announcements are made, that such announced product(s) and/or Service(s) embody any or all of the ideas, technologies, or concepts contained herein; nor
- c) any form of relationship between any MEF member companies and the recipient or user of this document.

Implementation or use of specific Metro Ethernet standards or recommendations and MEF specifications will be voluntary, and no company shall be obliged to implement them by virtue of participation in the Metro Ethernet Forum. The MEF is a non-profit international organization accelerating industry cooperation on Metro Ethernet technology. The MEF does not, expressly or otherwise, endorse or promote any specific products or Services.

© The Metro Ethernet Forum 2014. All Rights Reserved.

Table of Contents

- 1. List of Contributing Members.....1**
- 2. Abstract1**
- 3. Terminology1**
- 4. Scope2**
 - 4.1 Changes from MEF 6.1.....2
- 5. Compliance Levels3**
- 6. Numerical Prefix Conventions.....4**
- 7. Introduction4**
- 8. Ethernet Service Definition Framework (Normative).....6**
 - 8.1 Common Service Attributes for all Service Types7
 - 8.2 Per UNI Attributes8
 - 8.2.1 Token Share8
 - 8.2.2 Values for per UNI Attributes9
 - 8.3 EVC Per UNI Attributes13
 - 8.4 Per EVC Attributes17
- 9. Ethernet Service Types.....18**
 - 9.1 Ethernet Line (E-Line) Service Type.....19
 - 9.2 Ethernet LAN (E-LAN) Service Type.....19
 - 9.3 Ethernet Tree (E-Tree) Service Type.....20
- 10. Service Definitions (Normative)22**
 - 10.1 Ethernet Private Line Service22
 - 10.2 Ethernet Virtual Private Line Service.....24
 - 10.3 Ethernet Private LAN Service27
 - 10.4 Ethernet Virtual Private LAN Service29
 - 10.5 Ethernet Private Tree Service31
 - 10.6 Ethernet Virtual Private Tree Service.....33
- 11. References.....36**
- Appendix A. Practical Examples of Ethernet Services (Informative)37**
 - A.1. Example: A Transport-oriented Ethernet Private Line (EPL) Service for Private Data Networking.39
 - A.2. Example: A Packet-oriented Ethernet Private Line Service for Public Data Networking43
 - A.3. Example: Ethernet Private Tree (EP-Tree) Service for Video Broadcast49
 - A.4. Example: Distance Learning (EVP-Tree) and Business Data (EVP-LAN)54
- Appendix B. Backwards Compatibility to MEF 6.1 Service60**
- Appendix C. Attribute Tables per Service.....67**
 - C.1. UNI Service Attributes for all Services67
 - C.2. EVC Per UNI Service Attributes for all Services68
 - C.3. EVC Service Attributes for all Services69

List of Figures

MEF 6.2	<p>© The Metro Ethernet Forum 2014. Any reproduction of this document, or any portion thereof, shall contain the following statement: "Reproduced with permission of the Metro Ethernet Forum." No user of this document is authorized to modify any of the information contained herein.</p>	Page i
----------------	---	---------------

Figure 1: UNI with Services from a Service Provider	5
Figure 2: Subscriber’s view of EVP-LAN Service	6
Figure 3: Ethernet Service Definition Framework.....	6
Figure 4: Structure of Attribute Tables.....	8
Figure 5: E-Line Service Type using Point-to-Point EVC	19
Figure 6: E-LAN Service Type using Multipoint-to-Multipoint EVC	20
Figure 7: E-Tree Service Type using Rooted-Multipoint EVC	21
Figure 8: E-Tree Service Type using Multiple Roots	21
Figure 9: Typical Use Case of multiple EVPL Services.....	25
Figure 10: Ethernet Virtual Private Line Service	25
Figure 11: Ethernet Virtual Private LAN (EVP-LAN) Service	30
Figure 12: Ethernet Virtual Private Tree (EVP-Tree) Service.....	34
Figure 13: Transport-Oriented Private Data Network Using the EPL Service	39
Figure 14: Example of Packet-Oriented Public Data Network Interconnect Using the EPL Service.....	44
Figure 15: EPL Service with Token Sharing Enabled (shown at UNI U3)	45
Figure 16: Example of Video Broadcast Delivery Using the EP-Tree Service	50
Figure 17: Example of Distance Learning and Business Data Using EVP-LAN and EVP-Tree Services.....	55

List of Tables

Table 1: Terminology and Definitions Table.....	2
Table 2: Numerical Prefix Conventions	4
Table 3: Ethernet Services	7
Table 4: UNI Service Attributes and parameter values for all Service Types	13
Table 5: EVC per UNI Service Attributes and parameter values for all Service Types	17
Table 6: EVC Service Attributes and parameter values for all Service Types	18
Table 7: UNI Service Attributes and parameters for the EPL Service.....	23
Table 8: EVC per UNI Service Attributes and parameters for the EPL Service.....	23
Table 9: EVC Service Attributes and parameters for the EPL Service.....	24
Table 10: UNI Service Attributes and parameters for EVPL Service.....	26
Table 11: EVC per UNI Service Attributes and parameters for EVPL Service.....	26
Table 12: EVC Service Attributes and parameters for the EVPL Service.....	27
Table 13: UNI Service Attributes and parameters for the EP-LAN Service	28
Table 14: EVC per UNI Service Attributes and parameters for the EP-LAN Service.....	28
Table 15: EVC Service Attributes and parameters for the EP-LAN Service.....	29
Table 16: UNI Service Attributes and parameters for the EVP-LAN Service.....	30
Table 17: EVC per UNI Service Attributes and parameters for the EVP-LAN Service.....	31
Table 18: EVC Service Attributes and parameters for the EVP-LAN Service.....	31
Table 19: UNI Service Attributes and parameters for the EP-Tree Service	32
Table 20: EVC per UNI Service Attributes and parameters for the EP-Tree Service	32
Table 21: EVC Service Attributes and parameters for the EP-Tree Service	33
Table 22: UNI Service Attributes and parameters for the EVP-Tree Service.....	34
Table 23: EVC per UNI Service Attributes and parameters for the EVP-Tree Service.....	35
Table 24: EVC Service Attributes and parameters for the EVP-Tree Service.....	35
Table 25: EVC Performance Attributes and Parameters per CoS Offering	39
Table 26: UNI attributes for Private Data Network using EPL Service	41
Table 27: EVC per UNI attributes for Private Data Network using EPL Service	43
Table 28: EVC attributes for Private Data Network using EPL Service	43
Table 29: UNI attributes for the Public Data Networking example using EPL Service	46
Table 30: EVC per UNI attributes for Public Data Networking using EPL Service	49
Table 31: EVC attributes for Public Data Networking using EPL Service	49

Table 32: UNI attributes for the video broadcast example using EP-Tree Service	51
Table 33: EVC per UNI attributes for the video broadcast example using EP-Tree Service	54
Table 34: EVC Service Attributes for the video broadcast example using EP-Tree Service.....	54
Table 35: UNI attributes for the distance learning, business data example	56
Table 36: EVC per UNI attributes for the distance learning, business data example	59
Table 37: EVC attributes for the distance learning, business data example	60
Table 38: UNI Service Attribute values for MEF 6.1 Service.....	62
Table 39: EVC Per UNI Service Attribute values for MEF 6.1 Service.....	65
Table 40: EVC Service Attribute values for MEF 6.1 Service	66
Table 41: Per UNI attributes and values.....	67
Table 42: EVC Per UNI attributes and values	68
Table 43: Per EVC attributes and values	69

1. List of Contributing Members

The following members of the MEF participated in the development of this document and have requested to be included in this list.

Adva Optical Networking SE	Huawei Technologies
Allstream	Infinera Corporation
AT&T	Iometrix
Bell Canada	KDDI
Calix	Microsemi
Carrier Ethernet Academy	NTT AT
Ceragon Networks	Omnitron Systems
China Telecom	Overture Networks
Ciena Corporation	PLDT (Phillipines Long Distance Phone Company)
Colt	RAD Data Communications
Comcast	Sprint
Ericsson	Time Warner Cable
EuNetworks	Verizon Business
Fujitsu Network Communications	

2. Abstract

This document defines three Service constructs called Ethernet Service Types and six Ethernet Services with Service Attributes and parameters as specified in MEF 10.3, “Ethernet Services Attributes” [6] and in MEF 45, “Multi-CEN Layer 2 Control Protocol” [17]. These Service Types are used to create Point-to-Point, Multipoint-to-Multipoint, and Rooted-Multipoint Ethernet Services that are either Port or VLAN based. This document supersedes and replaces MEF 6.1, Ethernet Services Definitions – Phase 2 [1]¹.

In addition, an informative appendix is provided showing examples of some of the defined Services. This document also provides guidance on backwards compatibility to a Service as defined in MEF 6.1, Ethernet Services Definitions – Phase 2 [1].

3. Terminology

This section defines the terms used in this document. In those cases where the normative definitions of terms are found in other documents the third column is used to provide the reference that is controlling.

Terms defined in MEF 10.3 [6], MEF 3 [1], MEF 17 [10], MEF 20 [11], MEF 23.1 [13], MEF 26.1 [14], MEF 30.1 [15], MEF 33 [16], Multi-CEN L2CP [17] are included in this document by reference and, hence, not repeated in table below.

¹ Note that MEF 6.1.1, L2CP Amendment to MEF 6.1 [5] is superseded by MEF 45, “Multi-CEN Layer 2 Control Protocol” [17]

Term	Definition	Reference
E-LAN Service Type	An Ethernet Service Type that is based on a Multipoint-to-Multipoint EVC.	This document
E-Line Service Type	An Ethernet Service Type that is based on a Point-to-Point EVC.	This document
EPL	Ethernet Private Line.	This document
EP-LAN	Ethernet Private LAN.	This document
EP-Tree	Ethernet Private Tree.	This document
E-Tree Service Type	An Ethernet Service Type that is based on a Rooted-Multipoint EVC.	This document
EVPL	Ethernet Virtual Private Line.	This document
EVP-LAN	Ethernet Virtual Private LAN.	This document
EVP-Tree	Ethernet Virtual Private Tree.	This document
N/S	Not Specified	This document
VLAN	Virtual LAN	IEEE Std 802.1Q™-2011 [1]

Table 1: Terminology and Definitions Table

4. Scope

This document focuses on Ethernet Virtual Connection (EVC) based Ethernet Services offered by a Service Provider (SP) to a Subscriber. It supersedes and replaces MEF 6.1 “Ethernet Services Definitions – Phase 2” [\[1\]](#). This document updates list of Service Attributes, values and requirements for Services based on Service Types – E-Line (based on a Point-to-Point EVC), E-LAN (based on a Multipoint-to-Multipoint EVC) and E-Tree (based on a Rooted-Multipoint EVC). These updated Service Attributes are those defined in “Ethernet Services Attributes Phase 3”, MEF 10.3 [\[6\]](#).

This document does not define how the Service Attributes are implemented. Where possible, recommendations for the Service Attributes and associated parameters are made for these Ethernet Services. All Services in this document provide connectivity among User Network Interfaces (UNIs) that might be in one or more Carrier Ethernet Networks (CENs). The SP might also be the Operator of a CEN or can be an organization that coordinates with the CENs to deliver the Services to a Subscriber.

This document does not define application-based Services that might be offered using these Ethernet Service Types, e.g., Internet Protocol (IP) Telephony Service, nor does it define non-Ethernet-based Services that might be offered over the CEN, e.g., Circuit Emulation Services over a Time Division Multiplexed (TDM) Service Interface (MEF 3, [\[1\]](#)). This document does not define how the Services are supported in the CEN using different transport and switching technologies.

4.1 Changes from MEF 6.1

Most technical changes are based on revisions or new attributes in MEF 10.3 [\[6\]](#). In addition, suitable requirements have been included based on material in other MEF specifications such as MEF 23.1 [\[13\]](#) and MEF 30.1 [\[15\]](#).

Other changes include:

- Terms defined in MEF 10.3 [6], MEF 3 [1], MEF 17 [10], MEF 20 [11], MEF 23.1 [13], MEF 26.1 [14], MEF 30.1 [15], MEF 33 [16], Multi-CEN L2CP [17] are included in this document by reference and, hence, not repeated in Section 3.
- All Sections: Requirement numbering
- Section 7: Clarify that this document is about a single SP view from the perspective of a Subscriber and a MEF 6.2 Service could cross one or more Operator CENs.
- Section 8: Updated (per UNI) and new (EVC per UNI, per EVC) tables for Service Attributes (Common to all Service Types) in alignment with MEF 10.3. Service OAM (previously as Section 9 of MEF 6.1 [1]) has been included as attributes in the per UNI (UNI MEG) and EVC per UNI (Subscriber and Test MEGs) tables. SP, EVC and ENNI MEGs (MEF 30.1, [15]) are not included in this document since they are relevant for a SP or CEN but not for a Subscriber.
- Section 9: (Service Types - was a subsection of Section 6 in MEF 6.1, [1]) has definitions of the Service Types
- Section 10: (Services - was Section 7 in MEF 6.1, [1]) has tables with the subsets of attributes that uniquely define the Services (Port and VLAN based)
- Layer 2 Control Protocol (L2CP) handling: (was Section 8 in MEF 6.1, [1] and Amendment MEF 6.1.1 [5]): The requirements for L2CP handling are in Multi-CEN L2CP [17] specification. This document includes only the attributes and values from Multi-CEN L2CP [17] specification. Also, options 1 and 2 for L2CP Processing in an EPL Service have now been included in Multi-CEN L2CP [17] specification.
- Section 11: Updated Reference list
- Appendices: Updated example Service definitions – new attributes, modified old attributes, adjusted parameter values. EPL example updated with use of MEF 10.3 Bandwidth Profile with token sharing among two Bandwidth Profile Flows. A new Appendix for backwards compatibility to MEF 6.1 has been included.

Services defined in this document are distinguished from MEF 6.1 [1] Services based on the support for Service Attributes as well as values for the attributes specified in MEF 10.3 [6] and this document. For example, EVPL, as specified in this document, includes the Source MAC Address Limit attribute while a MEF 6.1 EVPL [1] Service can be defined with this attribute not supported or disabled if supported. Hence, if the new attributes are disabled and other attributes use values specified in MEF 10.2 [7], then the Service is same as a MEF 6.1[1] Service. This might be useful in cases where a Service spans multiple CENs but some CENs support MEF 6.1 [1] Service Attributes only. See Section [Appendix B](#) for configuration of attributes to support a MEF 6.1 Service.

5. Compliance Levels

The key words “**MUST**”, “**MUST NOT**”, “**REQUIRED**”, “**SHALL**”, “**SHALL NOT**”, “**SHOULD**”, “**SHOULD NOT**”, “**RECOMMENDED**”, “**MAY**”, and “**OPTIONAL**” in this

document are to be interpreted as described in RFC 2119 [2]. All key words use upper case, bold text.

A paragraph preceded by [**R***x*], where *x* indicates a sequentially increasing number throughout the document, specifies a mandatory requirement that **MUST** be followed. A paragraph preceded by [**D***y*], where *y* indicates a sequentially increasing number throughout the document, specifies a desired requirement that **SHOULD** be followed. A paragraph preceded by [**O***z*], where *z* indicates a sequentially increasing number throughout the document, specifies an optional requirement that **MAY** be followed.

A paragraph preceded by [**CR***a*]<, where *a* indicates a sequentially increasing number throughout the document, specifies a mandatory requirement that **MUST** be followed if the condition(s) following the "<" have been met. For example, "[**CR1**]<[D38]" indicates that conditional requirement 1 must be followed if desired requirement 38 has been met. A paragraph preceded by [**CD***b*]<, where *b* indicates a sequentially increasing number throughout the document, specifies a desired requirement that **SHOULD** be followed if the condition(s) following the "<" have been met. A paragraph preceded by [**CO***c*]<, where *c* indicates a sequentially increasing number throughout the document, specifies an optional requirement that **MAY** be followed if the condition(s) following the "<" have been met.

6. Numerical Prefix Conventions

When necessary this document uses the prefix notation to indicate multiplier values as shown in [Table 2](#).

Decimal		Binary	
Symbol	Value	Symbol	Value
k	10 ³	Ki	2 ¹⁰
M	10 ⁶	Mi	2 ²⁰
G	10 ⁹	Gi	2 ³⁰
T	10 ¹²	Ti	2 ⁴⁰
P	10 ¹⁵	Pi	2 ⁵⁰
E	10 ¹⁸	Ei	2 ⁶⁰
Z	10 ²¹	Zi	2 ⁷⁰
Y	10 ²⁴	Yi	2 ⁸⁰

Table 2: Numerical Prefix Conventions

7. Introduction

Ethernet has its origins in providing Local Area Network (LAN) connectivity and was not originally used to provide wide area Services. Service Providers have started using this Ethernet "connectivity" technology to provide Ethernet Services between two or more Subscriber locations. While the IEEE Std 802.3™ Ethernet protocol is still used, Service-related attributes and parameters need to be added in order to create an Ethernet Service. A UNI, per MEF 10.3 [6], is used to interconnect the customer equipment to the Service Provider network and instantiate Services specified in this document.

This document uses the Service Attributes and parameters that are defined in MEF 10.3 Technical Specification "Ethernet Services Attributes Phase 3" [6] and applies them to different

Ethernet Services. As MEF 10.3 [6] states, the Ethernet Services are modeled from the perspective of a Subscriber and the Service is in terms of what is seen by each Customer Edge (CE). An Ethernet Service consists of the EVC and the UNIs “in the EVC” that are defined using the Service Attributes along with a Service Level Specification (SLS) in a Service Level Agreement (SLA).

Ethernet Services specified in this document can span one or more Operator CENs² [14], such as Access Providers (APs, [16]), and a Service Provider (SP) offers Services to a Subscriber, as listed in Table 3, at a given UNI. A UNI is always dedicated to a single Subscriber (MEF 10.3, [6]). As shown in Figure 1 below, the Service Provider, might offer a Subscriber an EVPL where both UNIs, e.g., UNI A and UNI B, are in the same Operator CEN A. Likewise, the SP, might offer an EVP-LAN to the same Subscriber where some of the UNIs, e.g., UNI A and UNI B, in the EVC for EVP-LAN are located in CEN A with CEN A playing the role of an AP [16].

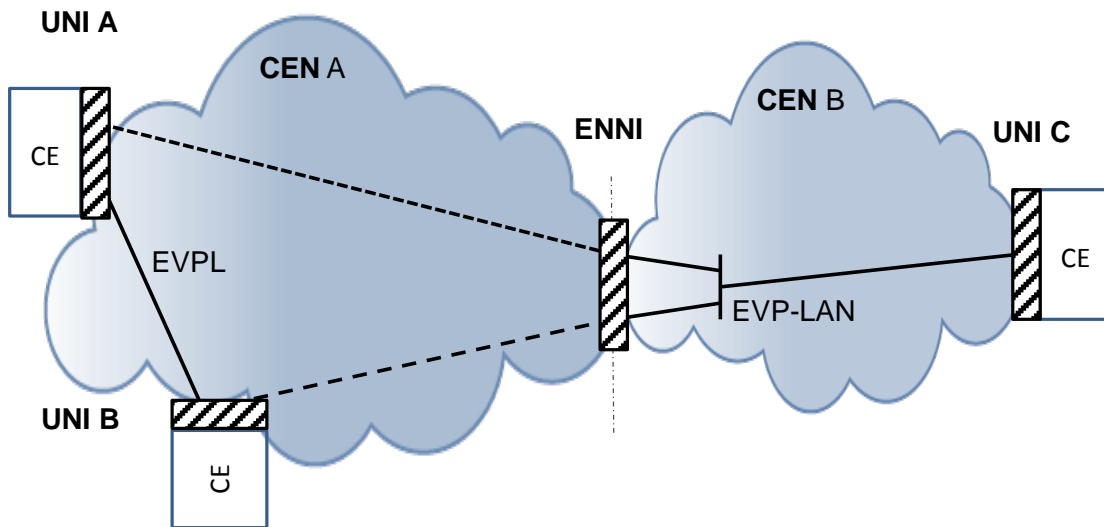

Figure 1: UNI with Services from a Service Provider

Within the context of a given EVC for the Ethernet Service, the Subscriber sees a single CEN, and a single Service Provider. For example, the EVP-LAN Service in Figure 1 will appear to the Subscriber’s point of view as shown in Figure 2. This document takes the Subscriber’s point of view and therefore all requirements in this document are on the SP for that given Service. It should be noted that when the term ‘support’ is used in a normative context in this document, it means that the SP is capable of enabling the functionality upon agreement between the Subscriber and the SP.

² “MEN” as used in MEF 26.1[14] is equivalent to “CEN”. This document uses “CEN”

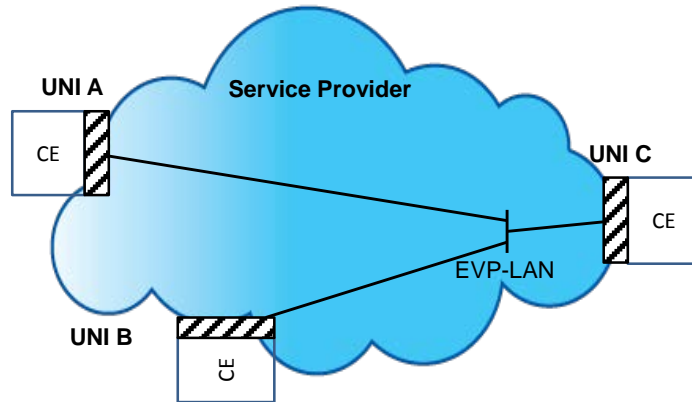

Figure 2: Subscriber’s view of EVP-LAN Service

This document defines Ethernet Service Types and specifies their associated Service Attributes and parameters for Point-to-Point, Multipoint-to-Multipoint, and Rooted-Multipoint Ethernet Services. This document also defines the requirements for several Ethernet Services that fall under these Ethernet Service Types.

These Services are agnostic of the underlying network infrastructure within the CEN and might be supported over any combination of network technologies in the Service Provider’s network.

8. Ethernet Service Definition Framework (Normative)

The Ethernet Service Definition Framework provides a model for specifying Ethernet Services. Ethernet Service Types are constructs used to create a broad range of Services. Each Ethernet Service Type has a set of Ethernet Service Attributes that define the Service characteristics. These Ethernet Service Attributes in turn have a set of parameters associated with them that provide various options for the different Service Attributes. This framework is shown in [Figure 3](#).

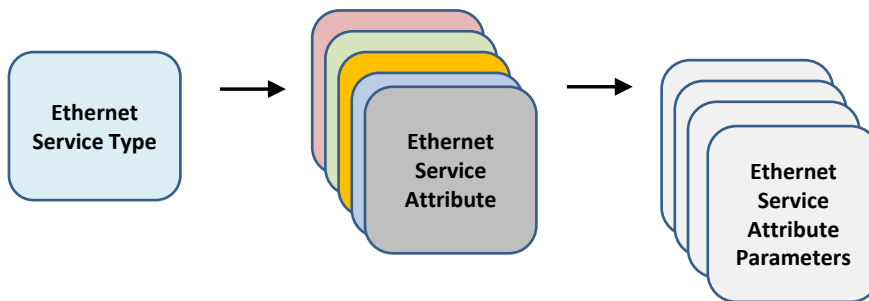

Figure 3: Ethernet Service Definition Framework

Using the enhanced set of Service Attributes from MEF 10.3 [6], this document defines three Ethernet Service Type constructs, namely, Ethernet Line (E-Line) Service Type (refer to Section

[9.1](#)), Ethernet LAN (E-LAN) Service Type (refer to Section [9.2](#)) and Ethernet Tree (E-Tree) Service Type (refer to Section [9.3](#)), and their associated Service Attributes and parameters. The key differentiator between the Service Types is the Type of connectivity provided, as indicated by the ‘EVC Type’ Service attribute. The UNI, EVC per UNI and EVC Service Attributes and parameters are normatively defined in MEF 10.3 [\[6\]](#).

[R1] The behavior for a Service Attribute **MUST** be per MEF 10.3 [\[6\]](#), Multi-CEN L2CP [\[17\]](#), and this document with additional constraints, if any, as specified in this document

More than one Ethernet Service is defined for each of the three Ethernet Service Types. These are differentiated by the method for Service identification used at the UNIs. Services using All to One Bundling UNIs (port-based) are referred to as ‘Private’, while Services using UNIs that identify the EVC using CE-VLAN ID (VLAN-based), are referred to as ‘Virtual Private’. This relationship is shown in [Table 3](#) below.

Service Type	Port-Based (All to One Bundling)	VLAN-Based (EVC identified by VLAN ID)
E-Line (Point-to-Point EVC)	Ethernet Private Line (EPL)	Ethernet Virtual Private Line (EVPL)
E-LAN (Multipoint-to-Multipoint EVC)	Ethernet Private LAN (EP-LAN)	Ethernet Virtual Private LAN (EVP-LAN)
E-Tree (Rooted-Multipoint EVC)	Ethernet Private Tree (EP-Tree)	Ethernet Virtual Private Tree (EVP-Tree)

Table 3: Ethernet Services

8.1 Common Service Attributes for all Service Types

The Service Attributes, parameters and values common to all Services shown in [Table 3](#) are grouped into separate tables for per UNI (Section [8.2](#)), EVC per UNI (Section [8.3](#)) and per EVC (Section [8.4](#)). The additional constraints, if any, with respect to definitions in MEF 10.3 [\[6\]](#) are specified as well. When an attribute has behavior as specified in MEF 10.3 [\[6\]](#) then this is indicated with ‘No additional constraints’.

Subsets of the attributes from the common tables (per UNI, EVC per UNI and per EVC) can have different values for each Service of a given Service Type. This is indicated in the common tables with ‘See Service specific Tables’. These subsets of attributes are described in Section 10 for the Services shown in Table 3. The relationship of the tables (common versus Service specific) is shown in Figure 4.

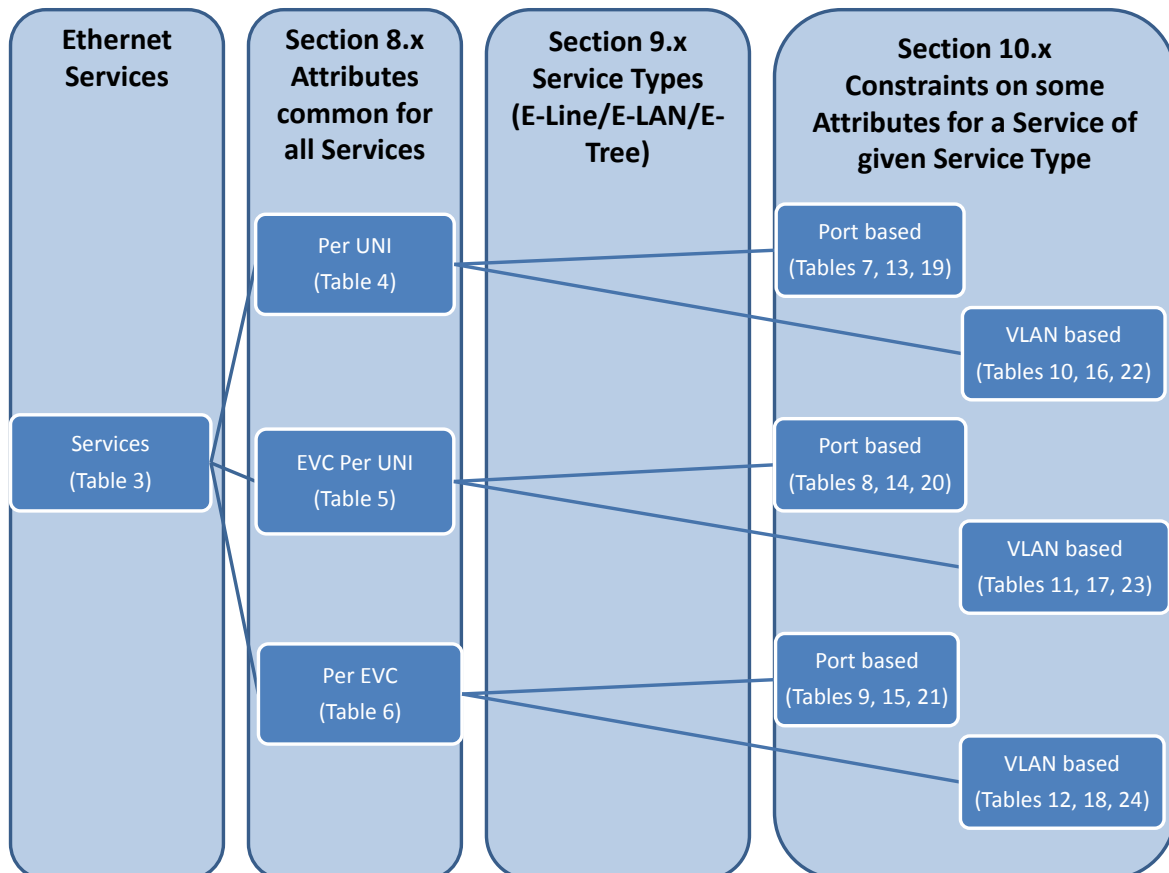

Figure 4: Structure of Attribute Tables

To get a complete picture of a given Service, the tables in Section 8.2, 8.3 and 8.4 need to be combined with the the additional requirements in the corresponding tables for the Service in Section 10. As an example, for EPL, the attributes listed in Section 10.1 have requirements that apply in addition to those in Section 8.2, 8.3 and 8.4.

The Service Types are discussed in Section 9.

8.2 Per UNI Attributes

8.2.1 Token Share

Token Share is a new per UNI Service Attribute defined in this document. This is used to indicate whether a given UNI is capable of sharing tokens across Bandwidth Profile Flows in an

Envelope. The allowed values, at each UNI, are *Enabled* or *Disabled*.

- [R2] A UNI, with Token Share *Enabled*, **MUST** be able to support two or more Bandwidth Profile Flows in at least one Envelope for Bandwidth Profile as specified in Section 11 of MEF 10.3 [6]
- [D1] A UNI, with Token Share *Enabled*, **SHOULD** be able to support two or more Bandwidth Profile Flows in every Envelope at that UNI.
- [R3] A UNI with Token Share *Disabled*, **MUST** have exactly one Bandwidth Profile Flow per Envelope

8.2.2 Values for per UNI Attributes

[Table 4](#) below specifies the UNI Service Attributes, parameters, and values that are common for all Ethernet Service Types. The first column of this table identifies the UNI Service Attributes, as defined in MEF 10.3 [6], Multi-CEN L2CP [17] and this document. The entries in the second and third columns specify the values and UNI requirements, respectively, regardless of the number or Type of EVCs present on the UNI. These requirements allow for options for certain UNI attributes, e.g., Physical Layer, Maximum Number of EVCs, application of Ingress and Egress Bandwidth Profiles, and Layer 2 Control Protocol Peering. Note that such options might be different at each UNI in the EVC.

UNI Service Attribute	Values and Description	Requirement
UNI ID	String as specified in Section 9.1 of MEF 10.3 [6]	No additional constraints
Physical Layer	<p>list of Physical Layers as specified in Section 9.2 of MEF 10.3 [6].</p> <p>A Subscriber and SP can agree on a UNI without Auto-negotiation by specifying, for example, 10Mbps or 100Mbps instead of 10/100 Mbps Auto-negotiation in the Service. Also, as specified in R80 of MEF 20 [11], a UNI can operate by disabling Auto-negotiation.</p> <p>The attribute allows different Speed values for links in the <i>list</i> but Subscriber and Service Provider can agree to have same values if the use case requires such a constraint.</p>	No additional constraints
Synchronous Mode	<p>list of Disabled or Enabled for each link in the UNI as specified in Section 9.3 of MEF 10.3 [6].</p> <p>When <i>Enabled</i> on a link in the UNI, this attribute allows Subscriber equipment to receive a bit clock reference at the physical layer.</p> <p>Additional requirements apply as per Multi-CEN L2CP [17]</p>	No additional constraints
Number of Links	<p>At least 1 as specified in Section 9.4 of MEF 10.3 [6].</p> <p>The protection mechanism is required to be identified with UNI Resiliency when the value is 2.</p>	No additional constraints

UNI Service Attribute	Values and Description	Requirement
UNI Resiliency	<p><i>None</i> or <i>2-link Aggregation</i> or <i>Other</i> as specified in Section 9.5 of MEF 10.3 [6].</p> <p>When the value is <i>2-link Aggregation</i>, then Subscriber and SP need to configure a single Link Aggregation Group (LAG) and enable LACP on those links in the LAG.</p> <p>Additional requirements apply as per Multi-CEN L2CP [17].</p> <p>When UNI has 2 links then MEF 30.1 [15] recommends that UNI MEG attribute is LAG MEG and that each link could be monitored with LAG Link MEG.</p>	No additional constraints
Service Frame Format	<i>IEEE Std 802.3 – 2012</i> as specified in Section 9.6 of MEF 10.3 [6].	No additional constraints
UNI Maximum Service Frame Size	<p><i>At least 1522</i> as specified in Section 9.7 of MEF 10.3 [6]</p> <p>Subscribers such as Mobile Operators might have a need to include additional encapsulation (MEF 22.1, [12]) in Service Frames sent across the UNI. Such use cases could benefit from a higher value of 1600Bytes for the EVCs at the UNI. See also EVC Maximum Service Frame Size attribute in Table 6.</p>	[D2] SHOULD be ≥ 1600 Bytes
Service Multiplexing	<i>Enabled or Disabled</i> as specified in Section 9.8 of MEF 10.3 [6]	See Service specific Tables
CE-VLAN ID for Untagged and Priority Tagged Service Frames	<p><i>A value in the range 1 to 4094</i> as specified in Section 9.9 of MEF 10.3 [6].</p> <p>This attribute can be considered to be not applicable when All to One Bundling is <i>Enabled</i>.</p>	No additional constraints
CE-VLAN ID/EVC Map	<i>A map</i> as specified in Section 9.10 of MEF 10.3 [6].	See Service specific Tables
Maximum number of EVCs	<i>At least 1</i> as specified in Section 9.11 of MEF 10.3 [6]	See Service specific Tables
Bundling	<i>Enabled or Disabled</i> as specified in Section 9.12 of MEF 10.3 [6]	See Service specific Tables
All to One Bundling	<i>Enabled or Disabled</i> as specified in Section 9.13 of MEF 10.3 [6].	See Service specific Tables
Token Share	<i>Enabled or Disabled</i> as specified in Section 8.2.1 of this document	No additional constraints from Section 8.2.1

UNI Service Attribute	Values and Description	Requirement
Envelopes	<p><i>list of <Envelope ID, CF⁰, n ></i>, where <Envelope ID, CF⁰> is as specified in Section 12.1 of MEF 10.3 [6] and <i>n</i> is the number of Bandwidth Profile Flows in the Envelope.</p> <p>When the UNI is not capable of multiple Bandwidth Profiles Flows within an Envelope then the Token Share attribute is <i>Disabled</i> at the UNI. In such a case the Envelopes attribute will be an empty list by [R5].</p>	<p>[R4] MUST be an empty <i>list</i> when all Ingress (Per UNI, per EVC, per Class of Service Identifier) and Egress (Per UNI, per EVC, per Egress Equivalence ID) Bandwidth Profile attributes have a value of <i>No</i>.</p> <p>[R5] MUST consist of only those Envelopes with two or more Bandwidth Profile Flows</p>
Ingress Bandwidth Profile Per UNI	<p><i>No</i> or <i>Parameters</i> as specified in Section 9.14 of MEF 10.3 [6].</p> <p>The Services specified in this document use Ingress Bandwidth Profile per Class of Service Identifier.</p>	<p>[R6] MUST be <i>No</i></p>
Egress Bandwidth Profile Per UNI	<p><i>No</i> or <i>Parameters</i> as specified in Section 9.15 of MEF 10.3 [6].</p> <p>The Services specified in this document use Egress Bandwidth Profile per Egress Equivalence Class Identifier.</p>	<p>[R7] MUST be <i>No</i></p>
Link OAM	<p><i>Enabled or Disabled</i> as specified in Section 9.16 of MEF 10.3 [6].</p> <p>Link OAM could be used, for example, when LAG Link MEG [15] is not used to monitor each link in a UNI with 2 links.</p> <p>Additional requirements apply as per Multi-CEN L2CP [17].</p>	<p>[D3] SHOULD be <i>Disabled</i> since MEF 30.1[15] recommends use of UNI MEG (or LAG MEG when 2 links)</p>
UNI MEG	<p><i>Enabled or Disabled</i> as specified in Section 9.17 of MEF 10.3 [6].</p> <p>MEF 30.1[15] recommends using UNI MEG or LAG MEG instead of Link OAM. When there are 2 links in the UNI, either LAG Link MEG or Link OAM could be used to monitor each link; but the choice needs to be same on both links.</p>	<p>[D4] SHOULD be <i>Enabled</i> instead of using Link OAM attribute when monitoring the UNI</p>

UNI Service Attribute	Values and Description	Requirement
E-LMI	<p><i>Enabled or Disabled</i> as specified in Section 9.18 of MEF 10.3 [6]</p> <p>The value of <i>Disabled</i> is recommended since this attribute is not expected to be used for MEF 6.2 Services. Additional requirements apply as per Multi-CEN L2CP [17].</p>	<p>[D5] SHOULD be <i>Disabled</i></p>
UNI L2CP Address Set	<p><i>CTB</i> or <i>CTB-2</i> or <i>CTA</i> as specified in Multi-CEN L2CP [17]</p>	<p>See Multi-CEN L2CP [17] for Service specific requirements</p>
UNI L2CP ³ Peering	<p><i>None</i> or <i>list of {Destination Address, Protocol Identifier}</i> or <i>list of {Destination Address, Protocol Identifier, Link Identifier}</i> to be Peered as specified in Multi-CEN L2CP [17]</p> <p>Protocols not in list are either Passed to EVC or Discarded based on the Destination Address.</p>	<p>See Multi-CEN L2CP [17] for Service specific requirements</p>

Table 4: UNI Service Attributes and parameter values for all Service Types

8.3 EVC Per UNI Attributes

Table 5 below specifies the EVC per UNI Service Attributes, parameters, and values that are common for all Ethernet Service Types. The first column of this table identifies the Service Attributes, as defined in MEF 10.3 [6]. The entries in the second and third columns specify the values and requirements, respectively, for the EVC at the UNI. These requirements allow for options for certain attributes, e.g., Source MAC Address Limit, application of Ingress and Egress Bandwidth Profiles per EVC, and Class of Service Identifier. Note that such options might be different at each UNI in the EVC.

³ See Section 8.5.1.1 of MEF 10.3[4] and Multi-CEN L2CP [17] for definition of L2CP Service Frame

EVC per UNI Service Attribute	Values and Description	Requirement
UNI EVC ID	<i>String</i> as specified in Section 10.1 of MEF 10.3 [6]	No additional constraints
Class of Service Identifier for Data Service Frame	<p><i>EVC</i> or <i>CE-VLAN CoS</i> or <i>IP</i> value(s) and corresponding CoS Name as specified in Section 10.2.1 of MEF 10.3 [6]</p> <p>As stated in MEF 10.3, a mapping of all Class of Service Identifier values to CoS Names at the UNI needs to be specified when value is <i>CE-VLAN CoS</i> or <i>IP</i>.</p>	<p>[D6] SHOULD use <i>EVC</i> as the Class of Service Identifier when 1 CoS Name in the EVC</p> <p>[D7] SHOULD support at least 1 CoS Label defined in MEF 23.1 [13]</p> <p>[CR1]< [D7] MUST use the mapping of Class of Service Identifier values that is specified in MEF 23.1 [13] to any supported CoS Label</p>
Class of Service Identifier for L2CP Service Frame	<p><i>“All”</i> or <i>list of each L2CP in the EVC</i> and corresponding CoS Name as specified in Section 10.2.2 of MEF 10.3 [6].</p>	<p>[D8] SHOULD map all L2CP frames to a single CoS Name that has a Frame Loss Objective in the SLS</p> <p>[D9] SHOULD be a CoS Name with CIR>0, CBS≥ EVC Maximum Service Frame Size</p> <p>[CD1]< [D8] SHOULD be same CoS Name at all UNIs in the EVC when non empty list of L2CP</p> <p>[CD2]< [D8] The CoS Name⁴ for L2CP frames SHOULD be with the lowest Frame Loss Ratio performance objective for the EVC.</p>
Class of Service Identifier for SOAM Service Frame	<p><i>Basis</i> same as for Data Service Frames as specified in Section 10.2.3 of MEF 10.3[6].</p> <p>This is applicable for SOAM Frames sent by Subscriber on Subscriber MEG.</p>	No additional constraints

⁴ One option could be using CoS Label as specified in Table 10 of MEF 23.1[11].

EVC per UNI Service Attribute	Values and Description	Requirement
Color Identifier for Service Frame	<p><i>None</i> or <i>EVC</i> or <i>CE-VLAN CoS</i> or <i>CE-VLAN Tag DEI</i> or <i>IP</i> as specified in Section 10.3 of MEF 10.3 [6].</p> <p>MEF 10.3 also has constraints on choice for Color ID based on choice for Class of Service Identifier. Additionally, as discussed in Section 7.6.2 of MEF 10.3, using DEI would allow the color to be changed when CE-VLAN CoS Preservation is Enabled.</p> <p>Note that Color Identifier applies to egress as well as ingress Service Frames. Color Identifier can be used to indicate to the Subscriber the color determined by an Ingress Bandwidth Profile. When <i>IP</i> is used to indicate color at egress note that Section 8.5.3 of MEF 10.3 requires that the MAC Client Data field, which includes <i>IP</i>, is identical at ingress and egress UNIs.</p>	No additional constraints
Egress Equivalence Class Identifier for Data Service Frames	<p><i>CE-VLAN CoS</i> or <i>IP</i> value(s) and corresponding CoS Name(s) as specified in Section 10.4.1 of MEF 10.3 [6].</p> <p>As stated in MEF 10.3, a mapping of all Egress Equivalence Class values to one or more CoS Names at the UNI needs to be specified when value is <i>CE-VLAN CoS</i> or <i>IP</i></p> <p>When there is no Egress Bandwidth Profile then this has no impact on the behavior of the Service at the UNI.</p>	<p>[D10] SHOULD be <i>CE-VLAN CoS</i> with all PCP values mapping to a single Egress Equivalence Class when Egress Bandwidth Profile per Equivalence Class is <i>No</i></p> <p>[D11] SHOULD be same mechanism as Class of Service Identifier at a given UNI</p> <p>[CD3]< [D11] SHOULD be <i>CE-VLAN CoS</i> with all PCP values mapping to a single Egress Equivalence Class when Class of Service Identifier is EVC</p>
Egress Equivalence Class Identifier for L2CP Service Frames	<p>“All” or list of each L2CP in the EVC and corresponding Egress Equivalence Class as specified in Section 10.4.2 of MEF 10.3 [6].</p> <p>When there is no Egress Bandwidth Profile then this has no impact on the behavior of the Service at the UNI.</p>	No additional constraints

EVC per UNI Service Attribute	Values and Description	Requirement
Egress Equivalence Class Identifier for SOAM Service Frames	<p>Basis same as for Data Service Frames as specified in Section 10.4.3 of MEF 10.3[6]</p> <p>This is applicable for SOAM Frames sent to Subscriber on Subscriber MEG.</p>	No additional constraints
Ingress Bandwidth Profile per EVC	<p>No or Parameters as specified in Section 10.5 of MEF 10.3[6]</p> <p>This document uses Ingress Bandwidth Profile per Class of Service Identifier.</p>	[R8] MUST be No
Egress Bandwidth Profile per EVC	<p>No or Parameters as specified in Section 10.6 of MEF 10.3[6]</p> <p>This document uses Egress Bandwidth Profile per Egress Equivalence Class Identifier.</p>	[R9] MUST be No
Ingress Bandwidth Profile per Class of Service Identifier	<p>No or Parameters with Bandwidth Profile as defined in Section 10.6 of MEF 10.3 [6].</p> <p>When the Ingress Bandwidth Profile per Class of Service Identifier attribute is with value of Parameters for the Service, the following is needed for each Bandwidth Profile Flow of Rank <i>i</i> in the Envelope: (a) the CoS Name, and (b) parameters {CIR^{<i>i</i>}, CIR^{<i>i</i>}_{max}, CBS^{<i>i</i>}, EIR^{<i>i</i>}, EIR^{<i>i</i>}_{max}, EBS^{<i>i</i>}, CF^{<i>i</i>}, CM^{<i>i</i>}, ER^{<i>i</i>}}. With more than 1 Bandwidth Profile Flow in the Envelope the parameters, with same Envelope ID but different Rank, will be specified in the EVC per UNI table for the specific EVC from which the Bandwidth Profile Flow is defined.</p> <p>A MEF 6.2 Service could be offered using one Bandwidth Profile Flow of frames in one Envelope, based on Class of Service Identifier as defined in Section 10.6 of MEF 10.3 [6], and the behavior is identical to MEF 10.2 [7] Bandwidth Profile per Class of Service Identifier implementation.</p>	<p>[R10] MUST specify as specified in Section 12.1 of MEF 10.3 [6], when value of Parameters, for Bandwidth Profile Flows in Envelopes that are listed in the Envelopes Attributes</p> <p>[R11] MUST specify only six parameters <CIR, CBS, EIR, EBS, CF, CM> when value of Parameters for those Bandwidth Profile Flows in Envelopes that are not listed in the Envelopes Attribute.</p> <p>[R12] MUST have CBS ≥ EVC Maximum Service Frame Size when CIR>0 for Bandwidth Profile Flows in Envelope.</p> <p>[R13] MUST have EBS ≥ EVC Maximum Service Frame Size when EIR>0 for Bandwidth Profile Flows in Envelope.</p> <p>See also [D9].</p>

EVC per UNI Service Attribute	Values and Description	Requirement
Egress Bandwidth Profile per Egress Equivalence Class	<p><i>No</i> or <i>Parameters</i> with Bandwidth Profile as defined in Section 10.8 of MEF 10.3 [6].</p> <p>When the Egress Bandwidth Profile per Equivalence Class attribute is with value of <i>Parameters</i> for the Service the following is needed for each Bandwidth Profile Flow of Rank <i>i</i> in the Envelope: (a) the Equivalence Class and (b) parameters {CIR^{<i>i</i>}, CIR^{<i>i</i>}_{max}, CBS^{<i>i</i>}, EIR^{<i>i</i>}, EIR^{<i>i</i>}_{max}, EBS^{<i>i</i>}, CF^{<i>i</i>}, CM^{<i>i</i>}, ER^{<i>i</i>}}. With more than 1 Bandwidth Profile Flow in the Envelope the parameters, with same or different Envelope ID and different Rank, will be specified in the EVC per UNI table for the specific EVC from which the Bandwidth Profile Flow is defined.</p> <p>With one Bandwidth Profile Flow of frames based on Egress Equivalence Class, as defined in Section 10.8 of MEF 10.3 [6], and one Envelope the behavior is identical to MEF 10.2 [7] Bandwidth Profile per Class of Service Identifier implementation.</p>	<p>[R14] MUST specify as specified in Section 12.1 of MEF 10.3 [6], when value of <i>Parameters</i> for Bandwidth Profile Flows in Envelopes that are listed in the Envelopes Attributes</p> <p>[R15] MUST specify only six parameters <CIR, CBS, EIR, EBS, CF, CM> when value of <i>Parameters</i> for those Bandwidth Profile Flows in Envelopes that are not listed in the Envelopes Attribute.</p> <p>[R16] MUST have CBS ≥ EVC Maximum Service Frame Size when CIR>0 for Bandwidth Profile Flows in Envelope.</p> <p>[R17] MUST have EBS ≥ EVC Maximum Service Frame Size when EIR>0 for Bandwidth Profile Flows in Envelope.</p> <p>See Service specific Tables</p>
Source MAC Address Limit	<i>Enabled</i> or <i>Disabled</i> as specified in Section 10.9 of MEF 10.3 [6].	See Service specific Tables
Test MEG	<i>Enabled</i> or <i>Disabled</i> as specified in Section 10.10 of MEF 10.3[6]	No additional constraints
Subscriber MEG MIP	<p><i>Enabled</i> or <i>Disabled</i> as specified in Section 10.11 of MEF 10.3[6].</p> <p>When <i>Enabled</i> for the UNI in a given EVC this allows the CEN to process Loopback and/or Linktrace messages as per MEF 30.1 [15].</p>	<p>[R18] MUST reserve use of at least MEG levels 6 and 7 for Subscriber MEG</p> <p>[O1] MAY additionally reserve use of MEG level 5 for Subscriber MEG</p> <p>[D12] SHOULD support (i.e., be capable of) <i>Enabled</i></p>

Table 5: EVC per UNI Service Attributes and parameter values for all Service Types

8.4 Per EVC Attributes

Table 6 below specifies the EVC Service Attributes, parameters, and values that are common for all Ethernet Service Types. The first column of this table identifies the EVC Service Attributes, as defined in MEF 10.3 [6]. The entries in the second and third column specify the values and requirements, respectively, for the EVC.

EVC Service Attribute	Values and Description	Requirement
EVC Type	<i>Point-to-Point</i> or <i>Multipoint-to-Multipoint</i> or <i>Rooted-Multipoint</i> as specified in Section 8.1 of MEF 10.3 [6].	See Service specific Tables
EVC ID	<i>String</i> as specified in Section 8.2 of MEF 10.3 [6].	No additional constraints
UNI List	<i>list of <UNI ID, UNI Role> pairs</i> as specified in Section 8.3 of MEF 10.3 [6] for UNIs associated by the EVC	See Service specific Tables
Maximum Number of UNIs	<i>two</i> or <i>three</i> or <i>greater</i> as specified in Section 8.4 of MEF 10.3 [6].	See Service specific Tables
Unicast Service Frame Delivery	<i>Discard</i> or <i>Deliver Unconditionally</i> or <i>Deliver Conditionally</i> as specified in Section 8.5.2 of MEF 10.3 [6].	See Service specific Tables
Multicast Service Frame Delivery	<i>Discard</i> or <i>Deliver Unconditionally</i> or <i>Deliver Conditionally</i> as specified in Section 8.5.2 of MEF 10.3 [6].	See Service specific Tables
Broadcast Service Frame Delivery	<i>Discard</i> or <i>Deliver Unconditionally</i> or <i>Deliver Conditionally</i> as specified in Section 8.5.2 of MEF 10.3 [6].	See Service specific Tables
CE-VLAN ID Preservation	<i>Enabled</i> or <i>Disabled</i> as specified in Section 8.6.1 of MEF 10.3 [6]	See Service specific Tables.
CE-VLAN CoS Preservation	<i>Enabled</i> or <i>Disabled</i> as specified in Section 8.6.2 of MEF 10.3 [6]	See Service specific Tables.
EVC Performance	<p><i>list of performance metrics and associated parameters and performance objectives</i> as specified in Section 8.8 of MEF 10.3 [6].</p> <p>The list can be empty when no SLS is specified for the EVC. A Performance metric can be N/S when no performance objective is specified for that performance metric in the SLS.</p> <p>As stated in [D7], the Class of Service Identifier could allow mapping to a CoS Label specified in MEF 23.1 [13].</p>	<p>[D13] SHOULD offer an SLS with at least one Performance Objective.</p> <p>[D14] SHOULD include one of {<i>FD, FDR</i>} or {<i>FD, IFDV</i>} or {<i>MFD, FDR</i>} or {<i>MFD, IFDV</i>} when Delay and Delay Variation performance objectives are specified in the SLS.</p> <p>See Service specific Tables</p>
EVC Maximum Service Frame Size	<p><i>At least 1522</i> as specified in Section 8.9 of MEF 10.3 [6].</p> <p>See also UNI Maximum Service Frame Size attribute in Table 4</p>	[D15] SHOULD be ≥ 1600 Bytes

Table 6: EVC Service Attributes and parameter values for all Service Types

9. Ethernet Service Types

The following subsections define each of the three Ethernet Service Types. Section 10 normatively defines the Ethernet Services.

9.1 Ethernet Line (E-Line) Service Type

Any Ethernet Service that is based on a Point-to-Point Ethernet Virtual Connection (EVC) is designated as an Ethernet Line (E-Line) Service Type. The E-Line Service Type is illustrated in [Figure 5](#).

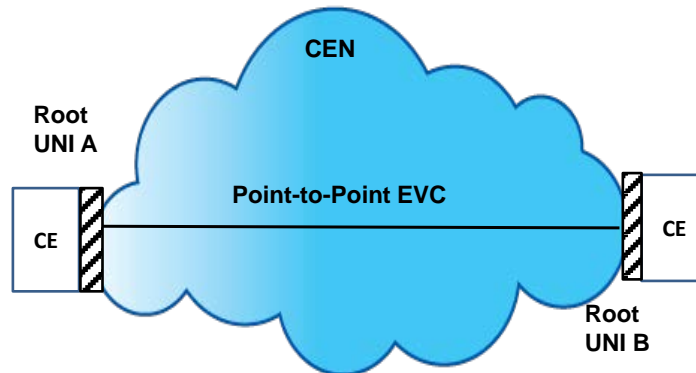

Figure 5: E-Line Service Type using Point-to-Point EVC

The E-Line Service Type is the basis for a broad range of Point-to-Point Services. In its simplest form, an E-Line Service Type can provide symmetrical bandwidth for data sent in either direction with no performance assurances, e.g., best effort Service between two 10Mbps UNIs. In more sophisticated forms, an E-Line Service Type can be between two UNIs with different line rates and can be defined with performance objectives such as delay, inter-frame delay variation, loss, and availability for a given Class of Service Name (CoS Name). Service Multiplexing might occur at one or both UNIs in the EVC. For example, more than one Point-to-Point EVC might be offered on the same physical port at one or both of the UNIs. One or more CoS Names might be associated with the Service.

All Service Attributes, parameters, and values can be found in [Table 4](#), [Table 5](#) and [Table 6](#). However, some of the attributes have parameters and values that are specific to Services of E-Line Service Type. See Section [10.1](#) for EPL Service and Section [10.2](#) for EVPL Service.

9.2 Ethernet LAN (E-LAN) Service Type

Any Ethernet Service that is based upon a Multipoint-to-Multipoint EVC is an Ethernet LAN (E-LAN) Service Type.

The E-LAN Service Type is illustrated in [Figure 6](#) below.

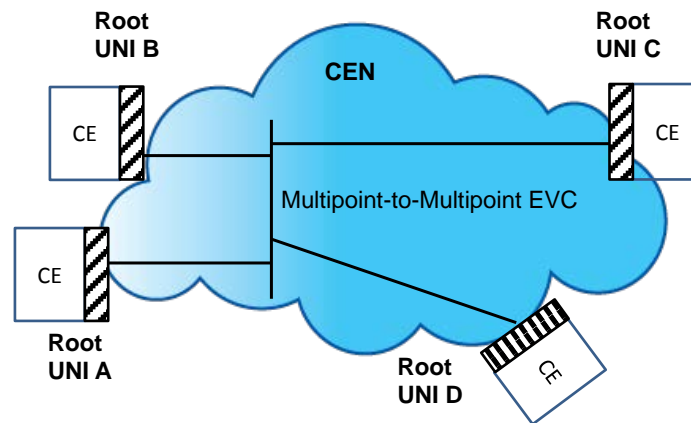

Figure 6: E-LAN Service Type using Multipoint-to-Multipoint EVC

The E-LAN Service Type is the basis for a broad range of Services. In its simplest form, an E-LAN Service Type can provide a best effort Service with no performance assurances between the UNIs. In more sophisticated forms, an E-LAN Service Type might be defined with performance objectives such as delay, inter-frame delay variation, loss, and availability for a given CoS Name. One or more CoS Names might be associated with the Service.

For an E-LAN Service Type, Service Multiplexing might occur at none, one, or more than one of the UNIs in the EVC. For example, an E-LAN Service Type (Multipoint-to-Multipoint EVC) and an E-Line Service Type (Point-to-Point EVC) might be Service Multiplexed at the same UNI. In this example, the E-LAN Service Type might be used to interconnect other Subscriber sites while the E-Line Service Type is used to connect to the Internet, with both Services offered via Service Multiplexing at the same UNI.

All Service Attributes, parameters, values and requirements can be found in [Table 4](#), [Table 5](#) and [Table 6](#). However, some of the attributes have parameters and values that are specific to Services of E-LAN Service Type. See Section [10.3](#) for EP-LAN Service and Section [10.4](#) for EVP-LAN Service.

9.3 Ethernet Tree (E-Tree) Service Type

Any Ethernet Service that is based upon a Rooted-Multipoint Ethernet Virtual Connection is an Ethernet Tree (E-Tree) Service Type.

The E-Tree Service Type with a single Root is illustrated in [Figure 7](#).

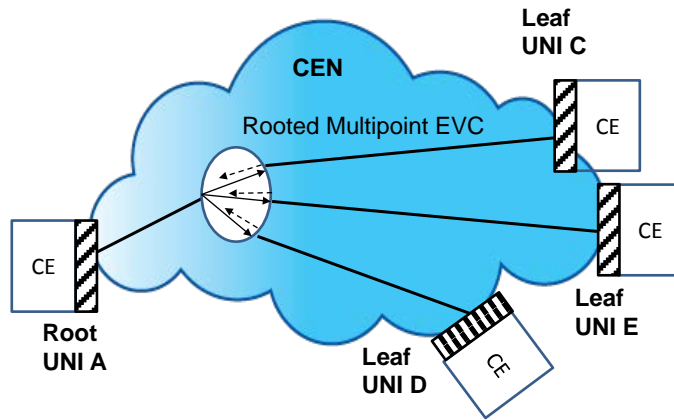

Figure 7: E-Tree Service Type using Rooted-Multipoint EVC

In its simplest form, an E-Tree Service Type can provide a single Root UNI for multiple Leaf UNIs. Each Leaf UNI can exchange all data service frames (Unicast, Multicast, Broadcast) with only the Root UNI. A Service frame sent from one Leaf UNI with a destination address for another Leaf UNI is not delivered. This Service could be useful for Internet Access or Video over IP applications, such as multicast/broadcast packet video. One or more than one CoS Names might be associated with this Service.

In more sophisticated forms, an E-Tree Service Type might support two or more Root UNIs. In this scenario, each Leaf UNI can exchange data only with the Root UNIs. As well, the Roots can communicate with each other. In such a Service, redundant access to ‘the Root’ can also be provided, effectively allowing for enhanced Service reliability and flexibility. This Service is depicted in [Figure 8](#) below.

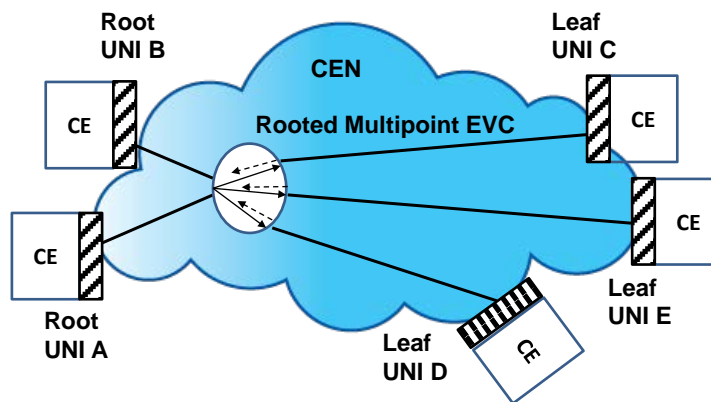

Figure 8: E-Tree Service Type using Multiple Roots

For an E-Tree Service Type, Service Multiplexing might occur at none, one, or more than one of the UNIs in the EVC. For example, an E-Tree Service Type and an E-Line Service Type might be Service Multiplexed at the same UNI. In this example, the E-Tree Service Type can be used

to support a specific application at the Subscriber UNI, e.g., Internet Service Provider access to redundant sites (multiple Roots), while the E-Line Service Type is used to connect to another enterprise site with a Point-to-Point EVC.

All Service Attributes, parameters, values and requirements can be found in [Table 4](#), [Table 5](#) and [Table 6](#). However, some of the attributes have parameters and values that are specific to Services of E-Tree Service Type. See Section [10.5](#) for EP-Tree Service and Section [10.6](#) for EVP-Tree Service.

10. Service Definitions (Normative)

An Ethernet Service is defined by specifying Service attribute parameter values for a given Ethernet Service Type. This section defines the required Service Attributes and related parameter values for the Ethernet Services specified in this Technical Specification. If any of the Ethernet Services in this section are offered, the normative text for each Service attribute is applied.

10.1 Ethernet Private Line Service

An Ethernet Private Line (EPL) Service is specified using an E-Line Service Type. An EPL Service uses a Point-to-Point EVC between two UNIs and provides a high degree of transparency for Service Frames between the UNIs it interconnects such that, as described in Section 8.5.3 and 8.6 of MEF 10.3 [\[6\]](#), most fields in each Service Frame are identical at both the source and destination UNI when the Service Frame is delivered. [Figure 5](#) shows the basic structure of an EPL Service.

EPL Service does not allow Service Multiplexing, i.e., dedicated UNIs are used for the Service. Because of the high degree of transparency of this Service, there is no need for coordination between the Subscriber and Service Provider on a detailed CE-VLAN ID/EVC Map for each UNI because all Service Frames are mapped to a single EVC at the UNI. Refer to MEF 10.3 [\[6\]](#) for more information on CE-VLAN ID/EVC Map attribute.

For cases where an ingress Bandwidth Profile is applied, the CE is expected to shape traffic to minimize the number of ingress Service Frames that are declared Red.

A MEF 6.2 EPL Service, unlike a MEF 6.1 [\[1\]](#) EPL Service, can be specified with one or more Envelopes at a UNI and, in addition, can include one or more Bandwidth Profile Flows based on CoS Name within each Envelope when Token Share attribute is set to *Enabled*.

In addition to the attributes listed in Section [8](#) some of the attributes, with values specific to Ethernet Private Line, are specified in this section.

[Table 7](#) provides the UNI Service Attributes, parameters, and values for the Ethernet Private Line.

UNI Service Attribute	Service Attribute Parameters and Values
Service Multiplexing	[R19] MUST be <i>Disabled</i>
Bundling	[R20] MUST be <i>Disabled</i>
All to One Bundling	[R21] MUST be <i>Enabled</i>
CE-VLAN ID / EVC Map	No additional constraints from Table 4 in Section 8.2. [R82] of MEF 10.3 [6] mandates that all CE-VLAN IDs map to the EVC when All to One Bundling is set to <i>Enabled</i> .
Maximum number of EVCs	[R22] MUST be <i>1</i>

Table 7: UNI Service Attributes and parameters for the EPL Service

[Table 8](#) provides the EVC per UNI Service Attributes, parameters, and values for the Ethernet Private Line (EPL) Service.

EVC per UNI Service Attribute	Service Attribute Parameters and Values
Egress Bandwidth Profile Per Egress Equivalence Class	[R23] MUST be <i>No</i> ⁵
Source MAC Address Limit	[R24] MUST be <i>Disabled</i>

Table 8: EVC per UNI Service Attributes and parameters for the EPL Service

[Table 9](#) provides the EVC Service Attributes, parameters, and values for the Ethernet Private Line (EPL) Service.

⁵ For EPL Services, it is expected that an Ingress Bandwidth Profile will be applied at the ingress UNI such that traffic on the EVC is already controlled; therefore, there is no need to apply an Egress Bandwidth Profile per Equivalence Class at the egress UNI.

EVC Service Attribute	Service Attribute Parameters and Values
EVC Type	[R25] MUST be <i>Point-to-Point</i>
UNI List	No additional constraints from MEF 10.3 [6]. Note that [R12] of MEF 10.3 mandates that each UNI in the list have the Role of <i>Root</i> .
Maximum Number of UNIs	No additional constraints from MEF 10.3 [6]. Note that [R13] of MEF 10.3 mandates maximum of <i>two</i> UNIs.
Unicast Service Frame Delivery	[R26] MUST be set to <i>Unconditional</i>
Multicast Service Frame Delivery	[R27] MUST be set to <i>Unconditional</i>
Broadcast Service Frame Delivery	[R28] MUST be set to <i>Unconditional</i>
CE-VLAN ID Preservation	[R29] MUST be <i>Enabled</i>
CE-VLAN CoS Preservation	[R30] MUST be <i>Enabled</i>
EVC Performance	<p>[CR2]< [D7] MUST use parameters and performance objectives as specified in MEF 23.1 [13] for performance metrics included in EVC Performance Service attribute when a Class of Service Name is CoS Label.</p> <p>The EVC Performance for a CoS Label can include performance metrics for which MEF 23.1 [13] does not specify performance objectives.</p> <p>[D16] SHOULD include both ordered UNI pairs in set <i>S</i></p>

Table 9: EVC Service Attributes and parameters for the EPL Service

10.2 Ethernet Virtual Private Line Service

An Ethernet Virtual Private Line (EVPL) is based on the E-Line Service Type. An EVPL can be used to create Services similar to the Ethernet Private Line (EPL) with some notable exceptions. An EVPL is allowed at a UNI with capability to map to a given EVC based on CE-VLAN ID. Depending on the value for Bundling attribute one or more CE-VLAN IDs can be mapped to an EVC. An additional difference compared to an EPL is that an EVPL can filter some L2CP Service Frames with certain destination address as specified in Multi-CEN L2CP [17].

It is not required to support more than one Ethernet Service at the UNI. With the Service Multiplexing Attribute set to *Enabled* more than one Ethernet Service can be supported at the UNI whereas EPL does not allow this. EVPL is commonly used for connecting Subscriber hub and branch locations as illustrated in Appendix A.2.1 of MEF 10.3 [6].

A MEF 6.2 EVPL Service, unlike a MEF 6.1 [1] EVPL Service, can be specified with one or more Envelopes at a UNI and, in addition, can include one or more Bandwidth Profile Flows based on CoS Name within each Envelope when Token Share attribute is set to *Enabled*.

When more than one EVC is supported at a UNI with Service Multiplexing Attribute set to *Enabled* then the EVC Types for other EVCs, at such a UNI, can be Point-to-Point (see Figure 9), Rooted-Multipoint or Multipoint-to-Multipoint (see Figure 11). Figure 9 shows the typical use case of connecting to a hub enterprise location at UNI A with EVPL_x from branch enterprise location at UNI B and with EVPL_y from branch enterprise location at UNI C.

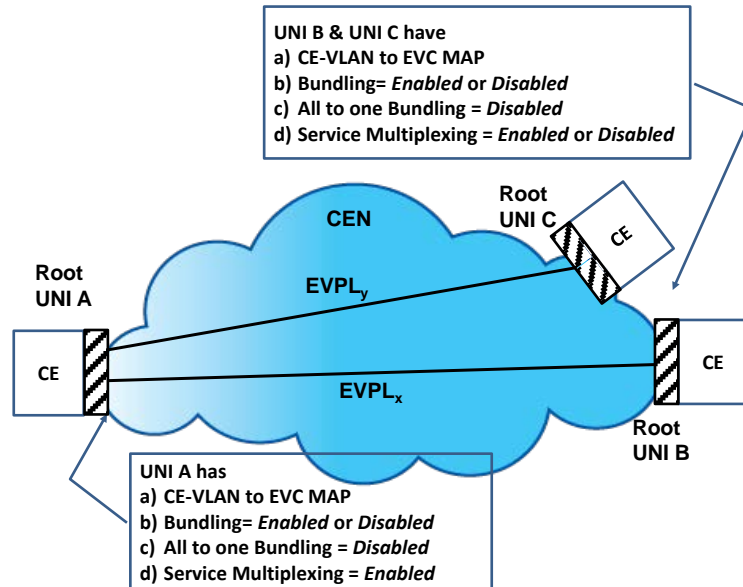

Figure 9: Typical Use Case of multiple EVPL Services

Figure 10 shows the basic structure of EVPL Service where there is a single instance of EVPL at each UNI. In this case, Service Multiplexing can be Disabled at each UNI.

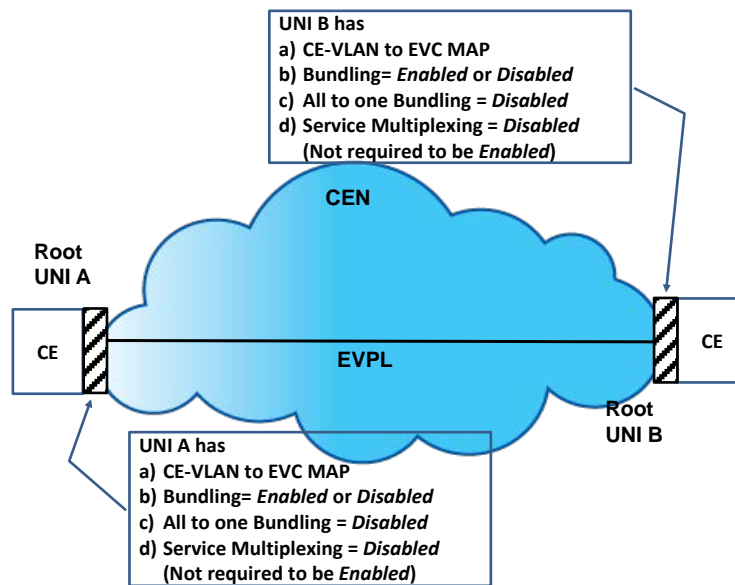

Figure 10: Ethernet Virtual Private Line Service

In addition to the attributes listed in Section 8.1 some of the attributes, with values specific to

Ethernet Virtual Private Line, are specified in this section.

[Table 10](#) provides the UNI Service Attributes, parameters, and values for the Ethernet Virtual Private Line (EVPL) using the E-Line Service Type.

UNI Service Attribute	Service Attribute Parameters and Values
Service Multiplexing	[D17] SHOULD be <i>Enabled</i> A UNI with one EVC, such as for the branch UNIs of the Service between hub and branch enterprise locations shown in Figure 34 of Appendix A.2.1 in MEF 10.3 [6], could have this Disabled.
Bundling	No additional constraints from Table 4 in Section 8.2
All to One Bundling	[R31] MUST be <i>Disabled</i>
CE-VLAN ID / EVC Map	No additional constraints from Table 4 in Section 8.2 . At least 1 CE-VLAN ID maps to each EVC.
Maximum number of EVCs	No additional constraints from Table 4 in Section 8.2

Table 10: UNI Service Attributes and parameters for EVPL Service

Table 11 provides the EVC per UNI Service Attributes, parameters, and values for the Ethernet Virtual Private Line (EVPL) using the E-Line Service Type.

EVC per UNI Service Attribute	Service Attribute Parameters and Values
Egress Bandwidth Profile Per Egress Equivalence Class	No additional constraints from Table 5 from Section 8.3 . Egress Service Frames that are conformant to an Egress Bandwidth Profile, when more than one EVC at the UNI, is expected to be helpful to the Subscriber (e.g., avoid buffer overflow in Subscriber's equipment).
Source MAC Address Limit	[R32] MUST be <i>Disabled</i> when [D18], [D19] and [D20] are all set to <i>Unconditional</i>

Table 11: EVC per UNI Service Attributes and parameters for EVPL Service

[Table 12](#) provides the EVC Service Attributes, parameters, and values for the Ethernet Virtual Private Line (EVPL) using the E-Line Service Type.

EVC Service Attribute	Service Attribute Parameters and Values
EVC Type	[R33] MUST be <i>Point-to-Point</i>
UNI List	No additional constraints from MEF 10.3 [6]. Note that [R12] of MEF 10.3 mandates that each UNI in the list have the Role of <i>Root</i> .
Maximum Number of UNIs	No additional constraints from MEF 10.3 [6]. Note that [R13] of MEF 10.3 mandates maximum of <i>two</i> UNIs.
Unicast Service Frame Delivery	[D18] SHOULD be set to <i>Unconditional</i>
Multicast Service Frame Delivery	[D19] SHOULD be set to <i>Unconditional</i>
Broadcast Service Frame Delivery	[D20] SHOULD be set to <i>Unconditional</i>
CE-VLAN ID Preservation	No additional constraints from Table 6 in Section 8.4
CE-VLAN CoS Preservation	No additional constraints from Table 6 in Section 8.4
EVC Performance	<p>[CR3]< [D7] MUST use parameters and performance objectives as specified in MEF 23.1 [13] for performance metrics included in EVC Performance Service attribute when a Class of Service Name is a CoS Label.</p> <p>The EVC Performance for a CoS Label can include performance metrics for which MEF 23.1 [13] does not specify performance objectives.</p> <p>[D21] SHOULD include both ordered UNI pairs in set <i>S</i></p>

Table 12: EVC Service Attributes and parameters for the EVPL Service

10.3 Ethernet Private LAN Service

Subscribers with multiple sites often want to interconnect them at high speeds so all sites appear to be on the same Local Area Network (LAN) and have equivalent performance and access to resources such as servers and storage. Subscribers commonly desire a highly transparent Service that connects multiple UNIs. To this end, the Ethernet Private LAN (EP-LAN) Service is defined in this subsection, using the E-LAN Service Type.

The EP-LAN Service is defined to provide CE-VLAN tag preservation. A key advantage of this approach is that the Subscriber can configure VLANs across the sites without any need to coordinate with the Service Provider. Each interface is configured for All to One Bundling and, therefore, EP-LAN Service supports CE-VLAN ID preservation. In addition, EP-LAN supports CE-VLAN CoS preservation.

An EP-LAN Service can be defined with one or more CoS Names and, hence, one or more Bandwidth Profile Flows based on Class of Service Identifier. A MEF 6.2 EP-LAN Service, unlike a MEF 6.1 [1] EP-LAN Service, can be specified with one or more Envelopes at a UNI and, in addition, can include one or more Bandwidth Profile Flows based on CoS Name within each Envelope when Token Share attribute is set to *Enabled*.

[Figure 6](#) shows the Multipoint-to-Multipoint EVC Type used for an EP-LAN Service. Each UNI associated by the EVC has one EVC.

In addition to the attributes listed in Section 8.1 some of the attributes, with values specific to Ethernet Private LAN, are specified in this section.

Table 13 provides the UNI Service Attributes, parameters, and values for the EP-LAN Service.

UNI Service Attribute	Service Attribute Parameters and Values
Service Multiplexing	[R34] MUST be <i>Disabled</i>
Bundling	[R35] MUST be <i>Disabled</i>
All to One Bundling	[R36] MUST be <i>Enabled</i>
CE-VLAN ID / EVC Map	No additional constraints from Table 4 in Section 8.2. [R82] of MEF 10.3 [6] mandates that all CE-VLAN IDs map to the EVC when All to One Bundling is set to <i>Enabled</i> .
Maximum number of EVCs	[R37] MUST be <i>1</i>

Table 13: UNI Service Attributes and parameters for the EP-LAN Service

Table 14 provides the EVC per UNI Service Attributes, parameters, and values for the EP-LAN Service.

EVC per UNI Service Attribute	Service Attribute Parameters and Values
Egress Bandwidth Profile Per Egress Equivalence Class	No additional constraints from Table 5 in Section 8.3
Source MAC Address Limit	No additional constraints from Table 5 in Section 8.3

Table 14: EVC per UNI Service Attributes and parameters for the EP-LAN Service

Table 15 provides the EVC Service Attributes, parameters, and values for the EP-LAN Service.

EVC Service Attribute	Service Attribute Parameters and Values
EVC Type	[R38] MUST be <i>Multipoint-to-Multipoint</i> .
UNI List	No additional constraints from MEF 10.3 [6]. Note that [R12] of MEF 10.3 mandates that each UNI in the list have the Role of <i>Root</i> .
Maximum Number of UNIs	No additional constraints from MEF 10.3 [6]. Note that [R14] of MEF 10.3 mandates maximum of <i>three or greater</i> .
Unicast Service Frame Delivery	[D22] SHOULD be <i>conditional</i> ⁶ with the condition that the delivery of Unicast Service Frames is subject to the dynamic learning and filtering process as described in IEEE Std 802.1Q-2011 [1] for Independent and Shared VLAN learning bridges
Multicast Service Frame Delivery	No additional constraints from Table 6 of Section 8.4 ⁷
Broadcast Service Frame Delivery	[D23] SHOULD be <i>unconditional</i> ⁷
CE-VLAN ID Preservation	[R39] MUST be <i>Enabled</i> .
CE-VLAN CoS Preservation	[R40] MUST be <i>Enabled</i> .
EVC Performance	No additional constraints from Table 6 in Section 8.4

Table 15: EVC Service Attributes and parameters for the EP-LAN Service

10.4 Ethernet Virtual Private LAN Service

Some Subscribers commonly desire an E-LAN Service Type to connect their UNIs in a network, while at the same time accessing other Services from one or more of those UNIs. An example of such a UNI is a Subscriber site that wants to access a public or private IP Service from a UNI that is also used for E-LAN Service Type among the Subscriber's several locations. We define the Ethernet Virtual Private LAN (EVP-LAN) Service in this subsection to address this need.

Bundling can be used on the UNIs in the Multipoint-to-Multipoint EVC. As such, CE-VLAN tag preservation. Figure 11 below shows the basic structure of EVP-LAN Service. In this example, the customer uses an EVP-LAN Service (solid black line for the EVC), associating UNIs A, B, C and D, for providing multipoint connectivity, and an EVPL Service (dashed red line for the EVC), associating UNI B and UNI E, for accessing other Service from UNI E. UNI B has Service Multiplexing capability to support greater than one EVC. The EVC Types for other EVCs, at such a UNI, can be Point-to-Point or Rooted-Multipoint or Multipoint-to-Multipoint.

⁶ Known MAC DA implies that the CEN is made aware of the presence of the DA at a specific UNI in the EVC. Unknown MAC DA handling is not specified by this condition. Other conditions might also apply.

⁷ For a Multipoint EVC, an ingress frame at a given UNI with a multicast MAC DA, or the broadcast MAC DA, would be forwarded to all egress UNIs in the EVC. This behavior supports the expectation of basic deployments. Conditional delivery might be used in some cases; such conditions might include multicast pruning on egress or ingress rate limiting of multicast and broadcast frames.

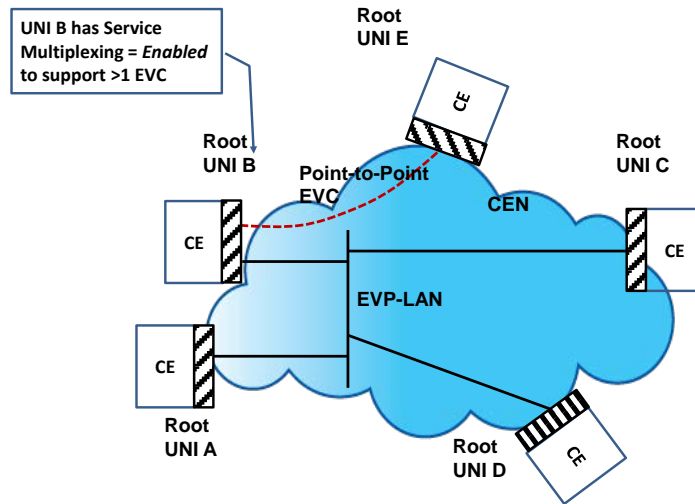

Figure 11: Ethernet Virtual Private LAN (EVP-LAN) Service

A MEF 6.2 EVP-LAN Service, unlike a MEF 6.1 [1] EVP-LAN Service, can be specified with one or more Envelopes at a UNI and, in addition, can include one or more Bandwidth Profile Flows based on CoS Name within each Envelope when Token Share attribute is set to *Enabled*.

In addition to the attributes listed in Section 8.1 the attributes with values specific to Ethernet Virtual Private LAN are specified in this section.

Table 16 provides the UNI Service Attributes, parameters, and values for the EVP-LAN Service.

UNI Service Attribute	Service Attribute Parameters and Values
Service Multiplexing	[D24] SHOULD be <i>Enabled</i> .
Bundling	No additional constraints from Table 4 in Section 8.2
All to One Bundling	[R41] MUST be <i>Disabled</i>
CE-VLAN ID / EVC Map	No additional constraints from Table 4 in Section 8.2. At least 1 CE-VLAN ID maps to each EVC.
Maximum number of EVCs	No additional constraints from Table 4 in Section 8.2

Table 16: UNI Service Attributes and parameters for the EVP-LAN Service

Table 17 provides the EVC per UNI Service Attributes, parameters, and values for the EVP-LAN Service.

EVC per UNI Service Attribute	Service Attribute Parameters and Values
Egress Bandwidth Profile Per Egress Equivalence Class	No additional constraints from Table 5 in Section 8.3
Source MAC Address Limit	No additional constraints from Table 5 in Section 8.3

Table 17: EVC per UNI Service Attributes and parameters for the EVP-LAN Service

[Table 18](#) provides the EVC Service Attributes, parameters, and values for the EVP-LAN Service.

EVC Service Attribute	Service Attribute Parameters and Values
EVC Type	[R42] MUST be <i>Multipoint-to-Multipoint</i> .
UNI List	No additional constraints from MEF 10.3 [6] . Note that [R12] of MEF 10.3 mandates that each UNI in the list have the Role of <i>Root</i> .
Maximum Number of UNIs	No additional constraints from MEF 10.3 [6] . Note that [R14] of MEF 10.3 mandates maximum of <i>three or greater</i> .
Unicast Service Frame Delivery	[D25] SHOULD be <i>conditional</i> ⁶ with the condition that the delivery of Unicast Service Frames is subject to the dynamic learning and filtering process as described in IEEE Std 802.1Q-2011 [1] for Independent and Shared VLAN learning bridges
Multicast Service Frame Delivery	No additional constraints from Table 6 of Section 8.4 ⁷
Broadcast Service Frame Delivery	[D26] SHOULD be <i>unconditional</i> ⁷
CE-VLAN ID Preservation	No additional constraints from Table 6 in Section 8.4
CE-VLAN CoS Preservation	No additional constraints from Table 6 in Section 8.4
EVC Performance	No additional constraints from Table 6 in Section 8.4

Table 18: EVC Service Attributes and parameters for the EVP-LAN Service

10.5 Ethernet Private Tree Service

Subscribers with multiple sites might want to interconnect them to provide Services other than those that resemble a LAN. These Services can be distributed from a centralized site (or few such sites) where the distribution site is designated as a *Root* and all the remaining sites are designated as *Leaf*.

The EP-Tree Service is defined to provide CE-VLAN tag preservation and tunneling of key Layer 2 Control Protocols. A key advantage of this approach is that the Subscriber can configure VLANs across the sites without any need to coordinate with the Service Provider. Each interface is configured for All to One Bundling and, therefore, EP-Tree Service supports CE-VLAN ID preservation. In addition, EP-Tree supports CE-VLAN CoS preservation.

An EP-Tree Service can be defined with one or more CoS Names and, hence, one or more Bandwidth Profile Flows based on Class of Service Identifier. A MEF 6.2 EP-Tree Service,

unlike a MEF 6.1 [1] EP-Tree Service, can be specified with one or more Envelopes at a UNI and, in addition, can include one or more Bandwidth Profile Flows based on CoS Name within each Envelope when Token Share attribute is set to Enabled.

[Figure 7](#). shows the Rooted-Multipoint EVC Type used for an Ethernet Private Tree Service. Each UNI associated by the EVC has one EVC.

In addition to the attributes listed in [Section 8.1](#) the attributes with values specific to Ethernet Private Tree are specified in this section.

[Table 19](#) provides the UNI Service Attributes, parameters, and values for the EP- Tree Service.

UNI Service Attribute	Service Attribute Parameters and Values
Service Multiplexing	[R43] MUST be <i>Disabled</i>
Bundling	[R44] MUST be <i>Disabled</i>
All to One Bundling	[R45] MUST be <i>Enabled</i>
CE-VLAN ID / EVC Map	No additional constraints from Table 4 in Section 8.2 . R82] of MEF 10.3 [6] mandates that all CE-VLAN IDs map to the EVC when All to One Bundling is set to <i>Enabled</i> .
Maximum number of EVCs	[R46] MUST be <i>1</i>

Table 19: UNI Service Attributes and parameters for the EP-Tree Service

[Table 20](#) provides the EVC per UNI Service Attributes, parameters, and values for the EP- Tree Service.

EVC per UNI Service Attribute	Service Attribute Parameters and Values
Egress Bandwidth Profile Per Egress Equivalence Class	No additional constraints from Table 5 in Section 8.3
Source MAC Address Limit	No additional constraints from Table 5 in Section 8.3

Table 20: EVC per UNI Service Attributes and parameters for the EP-Tree Service

[Table 21](#) provides the EVC Service Attributes, parameters, and values for the EP-Tree Service.

EVC Service Attribute	Service Attribute Parameters and Values
EVC Type	[R47] MUST be <i>Rooted-Multipoint</i>
UNI List	<p>[R48] MUST be capable of ≥ 2 for the number of UNIs with Role of <i>Leaf</i> associated by the EVC</p> <p>No additional constraints from MEF 10.3 [6]. Note that [R4] of MEF 10.3 mandates that one or more UNIs in the list have the Role of <i>Root</i> and [R5] of MEF 10.3 mandates that each of the UNIs not having the <i>Root</i> Role have <i>Leaf</i> Role.</p> <p>[R48] requires the Service Provider to allow a Service to have at least two UNIs with Role of <i>Leaf</i> in the Service. However, the subscriber could start with two UNIs with Role of <i>Root</i> in the Service but have zero UNIs with Role of <i>Leaf</i> and subsequently add UNIs with Role of <i>Leaf</i> to this Service.</p>
Maximum Number of UNIs	No additional constraints from MEF 10.3 [6]. Note that [R14] of MEF 10.3 mandates maximum of <i>three or greater</i> .
Unicast Service Frame Delivery	[D27] SHOULD be <i>conditional</i> ^{8 9} with the condition that the delivery of Unicast Service Frames is subject to the dynamic learning and filtering process as described in IEEE Std 802.1Q-2011 [1] for Independent and Shared VLAN learning bridges
Multicast Service Frame Delivery	No additional constraints from Table 6 of Section 8.4 ¹⁰
Broadcast Service Frame Delivery	[D28] SHOULD be <i>unconditional</i> ¹⁰
CE-VLAN ID Preservation	[R49] MUST be <i>Enabled</i>
CE-VLAN CoS Preservation	[R50] MUST be <i>Enabled</i>
EVC Performance	No additional constraints from Table 6 in Section 8.4

Table 21: EVC Service Attributes and parameters for the EP-Tree Service

10.6 Ethernet Virtual Private Tree Service

Some Subscribers desire access to certain applications or content Services from well-defined access points within their own (or an external) network. In this case it is necessary to interconnect the participating UNIs in a Rooted-Multipoint connection to the well-defined access (or root) point. For such cases, the EVP-Tree Service is used. One or more of the Subscriber's UNIs can also support other Services, e.g., EVPL or EVP-LAN. The EVC Types for other EVCs, at such a UNI, can be Point-to-Point or Multipoint or Rooted Multipoint.

⁸ For a Rooted Multipoint EVC, forwarding constraints involving roots and leaves, as specified in MEF 10.3 [4], apply to all frame types – unicast, multicast and broadcast.

⁹ Other conditions could apply.

¹⁰ For a Rooted Multipoint EVC, an ingress frame at a given UNI with a multicast MAC DA, or the broadcast MAC DA, would be forwarded to all egress UNIs in the EVC with the constraints imposed related to Roots and Leaves for Deliver Unconditionally per Section 8.5.2 of MEF 10.3 [4]. This behavior supports the expectation of basic deployments. Conditional delivery can be used in some cases; such conditions can include multicast pruning on egress or ingress rate limiting of multicast and broadcast frames, or other conditions

Bundling can be used on the UNIs in the Rooted-Multipoint EVC. As such, CE-VLAN tag preservation can be provided. [Figure 12](#) below shows the basic structure of EVP-Tree Service. In this example, a customer has EVP-LAN Service (dashed red line for the EVC) providing data connectivity among four UNIs, while using EVP-Tree Service (solid black line for the EVC) for providing video broadcast from a video hub location.

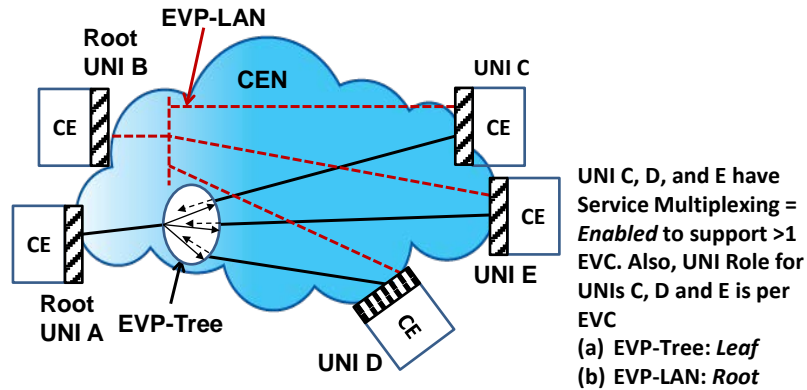

Figure 12: Ethernet Virtual Private Tree (EVP-Tree) Service

A MEF 6.2 EVP-Tree Service, unlike a MEF 6.1 [1] EVP-Tree Service, can be specified with one or more Envelopes at a UNI and, in addition, can include one or more Bandwidth Profile Flows based on CoS Name within each Envelope when Token Share attribute is set to *Enabled*.

In addition to the attributes listed in Section 8.1 the attributes with values specific to Ethernet Virtual Private Tree are specified in this section.

[Table 22](#) provides the UNI Service Attributes, parameters, and values for the EVP-Tree Service.

UNI Service Attribute	Service Attribute Parameters and Values
Service Multiplexing	[D29] SHOULD be <i>Enabled</i> .
Bundling	No additional constraints from Table 4 in Section 8.2
All to One Bundling	[R51] MUST be <i>Disabled</i>
CE-VLAN ID / EVC Map	No additional constraints from Table 4 in Section 8.2. At least 1 CE-VLAN ID maps to each EVC.
Maximum number of EVCs	No additional constraints from Table 4 in Section 8.2

Table 22: UNI Service Attributes and parameters for the EVP-Tree Service

Table 23 provides the EVC per UNI Service Attributes, parameters, and values for the EVP-Tree Service.

EVC per UNI Service Attribute	Service Attribute Parameters and Values
Egress Bandwidth Profile Per Egress Equivalence Class	No additional constraints from Table 5 in Section 8.3
Source MAC Address Limit	No additional constraints from Table 5 in Section 8.3

Table 23: EVC per UNI Service Attributes and parameters for the EVP-Tree Service

[Table 24](#) provides the EVC Service Attributes, parameters, and values for the EVP-Tree Service.

EVC Service Attribute	Service Attribute Parameters and Values
EVC Type	[R52] MUST be <i>Rooted-Multipoint</i>
UNI List	[R53] MUST be capable of ≥ 2 for the number of UNIs with Role of <i>Leaf</i> associated by the EVC No additional constraints from MEF 10.3 [6]. Note that [R4] of MEF 10.3 mandates that one or more UNIs in the list have the Role of <i>Root</i> and [R5] of MEF 10.3 mandates that each of the UNIs not having the <i>Root</i> Role have <i>Leaf</i> Role. [R53] requires the Service Provider to allow a Service to have at least two UNIs with Role of <i>Leaf</i> in the Service. However, the subscriber could start with two UNIs with Role of <i>Root</i> in the Service but have zero UNIs with Role of <i>Leaf</i> and subsequently add UNIs with Role of <i>Leaf</i> to this Service.
Maximum Number of UNIs	[R54] MUST be ≥ 3
Unicast Service Frame Delivery	[D30] SHOULD be <i>conditional</i> ^{8 9} with the condition that the delivery of Unicast Service Frames is subject to the dynamic learning and filtering process as described in IEEE Std 802.1Q-2011 [1] for Independent and Shared VLAN learning bridges
Multicast Service Frame Delivery	No additional constraints from Table 6 of Section 8.4 ¹⁰
Broadcast Service Frame Delivery	[D31] SHOULD be <i>unconditional</i> ¹⁰
CE-VLAN ID Preservation	No additional constraints from Table 6 in Section 8.4
CE-VLAN CoS Preservation	No additional constraints from Table 6 in Section 8.4
EVC Performance	No additional constraints from Table 6 in Section 8.4

Table 24: EVC Service Attributes and parameters for the EVP-Tree Service

11. References

1. IEEE Std 802.1Q™ – 2011, “Media Access Control (MAC) Bridges and Virtual Bridged Local Area Networks”, August 2011
2. IETF RFC 2119, “Key words for use in RFCs to Indicate Requirement Levels, March 1997”
3. MEF Technical Specification MEF 3, “Circuit Emulation Service Definitions, Framework and Requirements in Metro Ethernet Networks”, April 13, 2004,
4. MEF Technical Specification MEF 6.1, “Ethernet Services Definitions - Phase 2”, April 2008
5. MEF Technical Specification MEF 6.1.1, “L2CP Amendment to MEF 6.1”, January 2012.
6. MEF Technical Specification MEF 10.3, “Ethernet Services Attributes Phase 3”, October 2013
7. MEF Technical Specification MEF 10.2, “Ethernet Services Attributes”, July 2009
8. MEF Technical Specification MEF 12.1, ETH layer Architecture, July 2010
9. MEF Technical Specification MEF 16, “Ethernet Local Management Interface”, January 2006
10. MEF Technical Specification MEF 17, “Service OAM Requirements & Framework – Phase 1”, April 2007
11. MEF Technical Specification MEF 20, “UNI Type 2 IA”, July 2008
12. MEF Technical Specification MEF 22.1, “Mobile Backhaul IA- Phase 2”, January 2012
13. MEF Technical Specification MEF 23.1, “Class of Service IA”, January 2012
14. MEF Technical Specification MEF 26.1, “ENNI”, January 2012
15. MEF Technical Specification MEF 30.1, “Service OAM Fault Management IA Phase 2”, April 2013
16. MEF Technical Specification MEF 33, “Access Services”, January 2012
17. MEF Technical Specification MEF 45, “Multi-CEN L2CP”, August 2014.

Appendix A. Practical Examples of Ethernet Services (Informative)

This appendix provides Service instance examples of the E-Line, E-LAN, and E-Tree Service Types defined in Section 9. These Service examples are assumed to be offered by a hypothetical Service Provider, ACME, offering a portfolio of Ethernet Services.

[Table 25](#) is used for defining an example of the EVC performance attributes, parameters, and values associated with each of the Classes of Service Name offered by ACME. The list of performance metrics for the EVC Performance Service Attribute might include a subset of performance metrics defined in MEF 10.3 [6]. In particular, One Way Multiple EVC Group Availability (A^M_G) is not included in the example since the performance metrics in Table 25 apply for a single EVC. For simplicity, it is assumed that the values for the performance parameters shown below apply to all Ethernet Services, i.e., E-Line, E-LAN, and E-Tree Service Types. In actuality, Service Providers might offer different CoS Names and associated performance attribute objectives for the three Service Types. Also, since the performance objective values have wide variance among Service Providers, actual numbers are not used for the performance objective values. However, when a SP offers MEF CoS Labels, then the parameters and performance objectives are as specified in MEF 23.1 [13]. MEF 10.3 [6] also requires that some parameters use the same values for all Performance metrics in the SLS.

[Table 25](#) is used as a reference for Ethernet Services in each of the examples in the following subsections.

Example: Ethernet Services (offered by the ACME Service Provider)				
EVC Performance Attribute	Parameters	Class of Service Name & Egress Equivalence Class		
		Krypton	Argon	Neon
		EEC-Krypton	EEC-Argon	EEC-Neon
Class of Service Identifier value when mechanism is based on Priority Code Point value (some examples use other mechanisms, e.g., EVC)	PCP value	5	3	1
One Way Frame Delay (FD)	Subset of ordered UNI pairs (S)	All	All	All
	FD performance objective	X ms	Y ms (Y>X)	Z ms (Z>Y)
	Percentile (P)	99.9%	99%	95%
	Time interval (T)	1 month	1 month	1 month
One Way Frame Delay Range (FDR)	Not Specified (N/S)			
One Way Mean Frame Delay (MFD)	Not Specified (N/S)			
Inter Frame Delay Variation (IFDV)	Subset of ordered UNI pairs (S)	All	All	All
	IFDV performance objective	Q ms	N/S	N/S
	Percentile (P)	99.9%	N/S	N/S
	Time interval (T)	1 month	N/S	N/S
	Pair interval ($\Delta\tau$)	1 s	N/S	N/S
One Way Frame Loss Ratio (FLR)	Subset of ordered UNI pairs (S)	All	All	All
	FLR performance objective	A%	B% (B>A)	C% (C>B)
	Time interval (T)	1 month	1 month	1 month
One Way Availability	Subset of UNI pairs (S)	All	All	All
	Availability performance objective	$\alpha\%$	$\beta\%$ ($\beta < \alpha$)	$\gamma\%$ ($\gamma < \beta$)
	Time interval (T)	1 month	1 month	1 month
	Number of consecutive small time intervals (n)	10	10	10
	Small time interval (Δt)	1 second	1 second	1 second
	Unavailability frame loss ratio threshold (C)	50%	75%	100%
One Way Group Availability (A_G)	Not Specified (N/S)			
One Way Multiple EVC Group Availability (A_G^M)	Not Specified (N/S)			
One Way High Loss Interval (HLI)	Not Specified (N/S)			

Example: Ethernet Services (offered by the ACME Service Provider)				
EVC Performance Attribute	Parameters	Class of Service Name & Egress Equivalence Class		
		Krypton	Argon	Neon
		EEC-Krypton	EEC-Argon	EEC-Neon
One Way Consecutive High Loss Interval (CHLI)	Not Specified (N/S)			

Table 25: EVC Performance Attributes and Parameters per CoS Offering

In [Table 25](#), the value ‘All’ in the ‘Subset of ordered UNI pairs’ entries, means that all possible ordered pairs of UNIs, e.g., for an E-Tree Service Type all ordered pairs where at least one UNI in each pair has the Role of *Root*, are included in the offering. The reader is directed to MEF 10.3 [\[6\]](#) for precise definitions of the CoS attributes and parameters.

A.1. Example: A Transport-oriented Ethernet Private Line (EPL) Service for Private Data Networking.

A popular application of transport-oriented (or circuit-like) EPL Services is to provide an interconnect Service between routing or switching equipment in an enterprise’s private data network. This need might arise when a Subscriber wishes to manage its own networking infrastructure and desires a transport Service that emulates as close as possible a dedicated circuit. In such scenario, the Service Provider provides point-to-point interconnect Services between 2 designated UNIs and allocates transport resources (capacity) according to the desired circuit rate (typically the UNI port speed).

Since the Subscriber wishes to manage its own packet network infrastructure the EPL Service needs to be configured to be highly transparent to the Subscriber traffic. Transparency here implies expectations for minimal interaction with client’s data frames, including associated management and control traffic between the Subscriber’s routers and switches. It also implies expectations for minimal flow variability to be introduced into the client’s data stream (i.e., circuit-like forwarding). This Service does not need an Ingress Bandwidth Profile.

The Service architecture is illustrated in [Figure 13](#) below. The red dots represent the UNIs and the red dash represents the EVC instance that realizes the EPL Service.

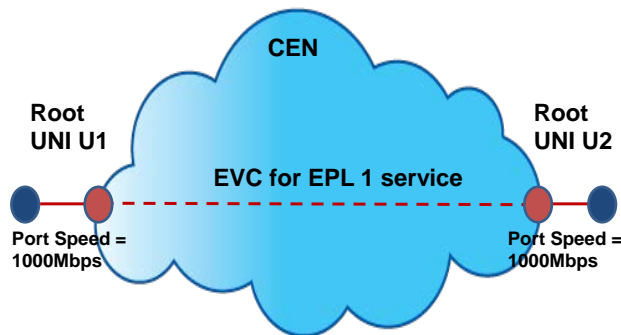

Figure 13: Transport-Oriented Private Data Network Using the EPL Service

The traffic pattern is that the Subscriber data, management and control frames are sent from UNI

to UNI over a symmetric path. Routing/switching equipment on the Subscriber side might send their own control messages without interference from the MEN. See [\[17\]](#) for requirements on handling Layer 2 Control Protocols for EPL Service.

In the case where the Subscriber wishes to have redundancy, a back-up EVC can be used with some redundancy protocol to ensure that only one of the EVCs is active at any time. Alternatively, two similar EPL Services can be instantiated between Sites A and B and allow for Subscriber CE port protection (e.g., by running LACP over the two EPL's to achieve a LAG between the CE's at the two Subscriber sites) by requiring the L2CP Address Set attribute for both EPL Services set to CTB-2 per Multi-CEN L2CP [\[0\]](#).

This example also does not use Link OAM at the UNI to monitor the status of the UNI since the Subscriber prefers to use Link OAM between the CEs with appropriate reserved Destination Address and hence is treated like Data Service Frame by the CEN. Alternatively, the Subscriber could use Service OAM at the Subscriber MEG [\[15\]](#) level to monitor the state of the EVC, as seen by the Subscriber's CE, with or without the CEN supporting the Subscriber MEG MIP.

For this case the suggested UNI attributes are depicted in [Table 26](#).

UNI Service Attribute	UNI 1	UNI 2
UNI Identifier	U1	U2
Physical Medium	{ 1000BASE-SX } Full Duplex Auto-negotiation: Disabled	{ 1000BASE-LX } Full Duplex Auto-negotiation: Disabled
Synchronous Mode	{ Disabled }	{ Disabled }
Number of Links	1	1
UNI Resiliency	None	None
Service Frame Format	IEEE Std 802.3 - 2012	IEEE Std 802.3 - 2012
UNI Maximum Service Frame Size	1522	1522
Service Multiplexing	Disabled	Disabled
CE-VLAN ID for untagged and priority tagged Service Frames	All CE-VLANs map to EVC EPL1	All CE-VLANs map to EVC EPL1
CE-VLAN ID / EVC Map	All CE-VLANs mapped to EPL1	All CE-VLANs mapped to EPL1
Maximum number of EVCs	1	1
Bundling	Disabled	Disabled
All to One Bundling	Enabled	Enabled
Token Share	Disabled	Disabled
Envelopes	{ } Empty list since no bandwidth profiles and also one flow in the Envelope	{ } Empty list since no bandwidth profiles and also one flow in the Envelope
Ingress Bandwidth Profile Per UNI	No	No
Egress Bandwidth Profile Per UNI	No	No
Link OAM	Disabled	Disabled
UNI MEG	Disabled	Disabled
E-LMI	Disabled	Disabled
UNI L2CP Address Set	CTB-2	CTB-2
UNI L2CP Peering	{ } Empty list since no protocols are Peered	{ } Empty list since no protocols are Peered

Table 26: UNI attributes for Private Data Network using EPL Service

[Table 27](#) provides the EVC per UNI attributes for the Private Data Networking example.

EVC per UNI Service Attribute	UNIs 1	UNI 2
UNI EVC ID	U1_EPL1	U2_EPL1
Class of Service Identifier for Data Service Frame	Class of Service Identifier mechanism= EVC CoS Name= Krypton Class of Service Identifier value= EVC ID	Class of Service Identifier mechanism= EVC CoS Name= Krypton Class of Service Identifier value= EVC ID
Class of Service Identifier for L2CP Service Frame	Class of Service Identifier mechanism= treated like Data Service Frames CoS Name= Krypton Class of Service Identifier values= {list ¹¹ of Protocols used by Subscriber}	Class of Service Identifier mechanism= treated like Data Service Frames CoS Name= Krypton Class of Service Identifier Values= {list ¹¹ of Protocols used by Subscriber}
Class of Service Identifier for SOAM Service Frame	CoS Name= Krypton Class of Service Identifier = same as Data Service Frames	CoS Name= Krypton Class of Service Identifier = same as Data Service Frames
Color ID for Service Frame	None	None
Egress Equivalence Class for Data Service Frame	Mechanism = All PCP values in EVC (No impact since no Egress Bandwidth Profile)	Mechanism = All PCP values in EVC (No impact since no Egress Bandwidth Profile)
Egress Equivalence Class for L2CP Service Frame	Not Specified (No impact since no Egress Bandwidth Profile)	Not Specified (No impact since no Egress Bandwidth Profile)
Egress Equivalence Class for SOAM Service Frame	All PCP values in EVC (No impact since no Egress Bandwidth Profile)	All PCP values in EVC (No impact since no Egress Bandwidth Profile)
Ingress Bandwidth Profile Per EVC	No	No
Egress Bandwidth Profile Per EVC	No	No
Ingress Bandwidth Profile Per Class of Service Identifier	No	No
Egress Bandwidth Profile Per Equivalence Class	No	No
Source MAC Address Limit	Disabled	Disabled

¹¹ [R99] of MEF 10.3 [6] mandates that a Service Frame carrying a Layer 2 Control Protocol not in the list is treated as a Data Service Frame. Since the Class of Service Identifier is based on EVC, the Class of Service Identifier for all Service Frames is the same and the content of the list is irrelevant. Consequently, the list can be empty which simplifies coordination between the Subscriber and the Service Provider

EVC per UNI Service Attribute	UNIs 1	UNI 2
Subscriber MEG MIP	Disabled	Disabled
Test MEG	Disabled	Disabled

Table 27: EVC per UNI attributes for Private Data Network using EPL Service

[Table 28](#) provides the EVC attributes for the private data networking example.

EVC Service Attribute	EVC_1
EVC Type	Point-to-Point
EVC ID	EPL1
UNI List	{<U1, Role=Root>, <U2, Role=Root>}
Maximum Number of UNIs	2
Unicast Service Frame Delivery	Deliver Unconditionally
Multicast Service Frame Delivery	Deliver Unconditionally
Broadcast Service Frame Delivery	Deliver Unconditionally
CE-VLAN ID Preservation	Enabled
CE-VLAN CoS Preservation	Enabled
EVC Performance	CoS Name = Krypton
EVC Maximum Service Frame Size	1522 (So, Untagged: 1518 & Tagged: 1522)

Table 28: EVC attributes for Private Data Network using EPL Service

A.2. Example: A Packet-oriented Ethernet Private Line Service for Public Data Networking

A popular application of packet-oriented (or statistical) EPL Services is to provide an interconnect Service between routing or switching equipment in an enterprise via a public data networking Service. This need arises when a Subscriber wishes to interconnect multiple sites but does not wish to manage the intermediate datacom facilities. In such scenario, the Service Provider provides point-to-point interconnect Services between 2 designated UNIs and allocates transport resources according to the anticipated traffic volume between the sites (typically less than the UNI port speed).

Since the Subscriber does not wish to manage its own packet network infrastructure there could be additional requirements at the UNI for L2CP Service Frames. The Service interfaces at the UNIs might operate at different Port Speeds, bandwidth allocation for traffic at each UNI might also be asymmetric. Non-essential traffic can be forwarded according to resource availability (i.e., statistical multiplexing).

The Service architecture is illustrated in [Figure 14](#) below. The red dots represent the UNIs and the red dash represents the EVC instance that realizes the EPL Service.

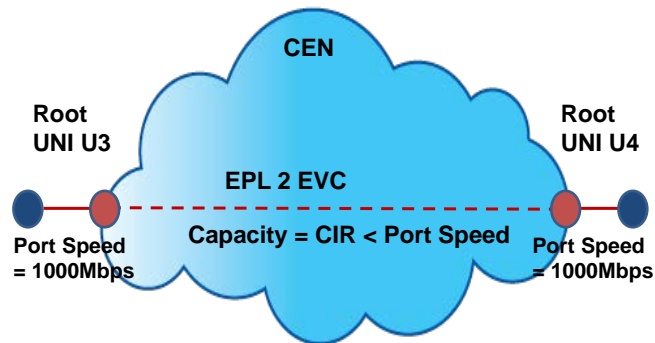

Figure 14: Example of Packet-Oriented Public Data Network Interconnect Using the EPL Service.

The traffic pattern is such that the Subscriber data, management and control frames are sent from UNI to UNI on different CoS Names. Different levels of performance are applicable depending on the traffic type (indicated via PCP marking).

In the case where the Subscriber wishes to have redundancy, a back-up EVC can be used with some redundancy protocol to ensure that only one of the EVCs is active at any time. The UNI can also be protected via link aggregation. For this case the suggested UNI attributes are depicted in [Table 29](#).

This example also shows how attributes like Subscriber MEG MIP and MEF 10.3 Bandwidth Profile with token sharing are used. Subscriber MEG MIP is used to offer a MIP for the EVC at the UNI. While, for example, the Subscriber MEG MIP might be offered at some or all UNIs in the EVC, this example assumes that Subscriber prefers to have the MIP enabled at both UNIs for the EPL Service. Also, the MIP is for the EVC albeit there are two CoS Names.

To illustrate MEF 10.3 token sharing, this example defines two Bandwidth Profile Flows in an Envelope. Further, the excess tokens are allowed to be shared from higher rank Bandwidth Profile Flow to lower rank Bandwidth Profile Flow. With $CF^0=0$ and $CF^i=0$ for $i=1$ to 2, this example is similar to the ‘Uncoupled Bandwidth Sharing’ example described in Appendix C.2.2 of MEF 10.3 [6] except for the number of Bandwidth Profile Flows in the example described here.

Figure 15 shows two Bandwidth Profile Flows at U3 of Figure 14 (same at U4 for this example) mapped based on CoS Name Krypton and Neon. The configuration for the Bandwidth Profile, described in Table 30 for EVC per UNI Service Attributes, is as follows:

- Envelope ID is EPL2 with Rank 1 for lower priority and Rank 2 for higher priority Bandwidth Profile Flows
- Overflows of Green tokens are not converted to Yellow tokens: $CF^0=0$, $CF^i = 0$ for $i=1,2$
- The EVC would allow green traffic up to $CIR=25Mbps$ and yellow traffic up to $EIR=50Mbps$

- Bandwidth Profile Flow with Rank 2 is allowed a maximum of $CIR^2_{max}=20Mbps$ and $EIR^2_{max}=0$. Given that $EBS^2=0$ all the Yellow tokens overflow to Bandwidth Profile Flow with Rank 1.
- Bandwidth Profile Flow with Rank 1 is allowed to use tokens up to $CIR^1_{max}=20Mbps$, if available due to overflow, and $EIR^1_{max}=50Mbps$. Note that $CIR^1=5Mbps$ so this flow is not starved of green tokens.

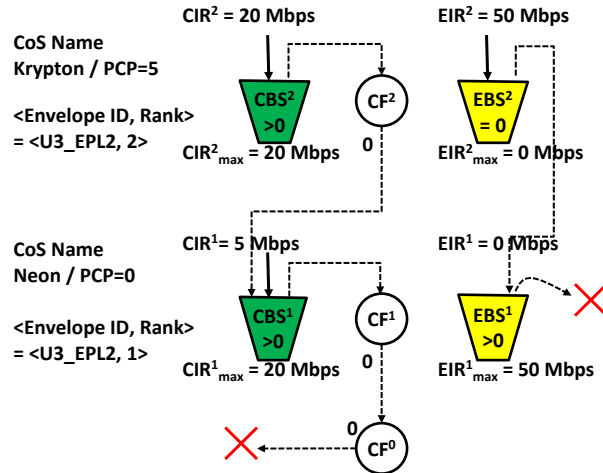

Figure 15: EPL Service with Token Sharing Enabled (shown at UNI U3)

UNI Service Attribute	UNI 3	UNI 4
UNI Identifier	U3	U4
Physical Layer	{ 1000BASE-SX, 1000BASE-LX } Full Duplex Auto-negotiation: Disabled	{ 100BASE-T4, 100BASE-TX } Full Duplex Auto-negotiation: Disabled
Synchronous Mode	{ Disabled, Disabled }	{ Disabled, Disabled }
Number of Links	2	2
UNI Resiliency	2-Link Aggregation	2-Link Aggregation
Service Frame Format	IEEE Std 802.3 - 2012	IEEE Std 802.3 - 2012
UNI Maximum Service Frame Size	1600	1600
Service Multiplexing	Disabled	Disabled
CE-VLAN ID for untagged and priority tagged Service Frames	All CE-VLANs map to EVC EPL2	All CE-VLANs map to EVC EPL2
CE-VLAN ID / EVC Map	All CE-VLANs mapped to EPL2	All CE-VLANs mapped to EPL2
Maximum number of EVCs	1	1
Bundling	Disabled	Disabled
All to One Bundling	Enabled	Enabled
Token Share	Enabled	Enabled
Envelopes	<Envelope ID=U3_EPL2, n=2, CF ⁰ =0>	<Envelope ID=U4_EPL2, n=2, CF ⁰ =0>
Ingress Bandwidth Profile Per UNI	No (since using per Class of Service Identifier)	No
Egress Bandwidth Profile Per UNI	No	No
Link OAM	Disabled	Disabled
UNI MEG	Enabled	Enabled
E-LMI	Disabled	Disabled
UNI L2CP Address Set	CTB	CTB
UNI L2CP Peering	{ LACP/LAMP }	{ LACP/LAMP }

Table 29: UNI attributes for the Public Data Networking example using EPL Service

Table 30 provides the EVC per UNI attributes for the Public Data Networking example.

EVC per UNI Service Attribute	UNI 3	UNI 4
UNI EVC ID	U3_EPL2	U4_EPL2
Class of Service Identifier for Data Service Frame	Class of Service Identifier mechanism= PCP CoS Name= Krypton Class of Service Identifier value=5 CoS Name= Neon Class of Service Identifier value= 1 CoS Name=Discard Class of Service Identifier value = 1-4, 6,7	Class of Service Identifier mechanism= PCP CoS Name= Krypton Class of Service Identifier value= 5 CoS Name= Neon Class of Service Identifier value=1 CoS Name=Discard Class of Service Identifier value = 1-4, 6,7
Class of Service Identifier for L2CP Service Frame	Class of Service Identifier mechanism= treated like Data Service Frames CoS Name = Krypton Class of Service Identifier values = {list ¹¹ of Protocols used by Subscriber}	Class of Service Identifier mechanism = treated like Data Service Frames CoS Name = Krypton Class of Service Identifier values = {list ¹¹ of Protocols used by Subscriber}
Class of Service Identifier for SOAM Service Frame	CoS Name= Krypton CoS Name= Neon (since Subscriber might monitor each class) Class of Service Identifier = same as Data Service Frames	CoS Name= Krypton CoS Name= Neon (since Subscriber might monitor each class) Class of Service Identifier = same as Data Service Frames
Color ID for Service Frame	None	None
Egress Equivalence Class for Data Service Frame	Mechanism= All PCP values in EVC (No impact since no Egress Bandwidth Profile)	Mechanism = All PCP values in EVC (No impact since no Egress Bandwidth Profile)
Egress Equivalence Class for L2CP Service Frame	Not Specified (No impact since no Egress Bandwidth Profile)	Not Specified (No impact since no Egress Bandwidth Profile)
Egress Equivalence Class for SOAM Service Frame	All PCP values in EVC (No impact since no Egress Bandwidth Profile)	All PCP values in EVC (No impact since no Egress Bandwidth Profile)
Ingress Bandwidth Profile Per EVC	No (Since using 'per Class of Service Identifier')	No
Egress Bandwidth Profile Per EVC	No	No

EVC per UNI Service Attribute	UNI 3	UNI 4
Ingress Bandwidth Profile Per Class of Service Identifier	<p>Parameters</p> <p>2 Bandwidth Profile Flows = frames mapped based on Class of Service Identifier of PCP</p> <p>Class of Service Identifier value = 5 for CoS Name=Krypton Class of Service Identifier value = 1 for CoS Name=Neon</p> <p>PCP = 5: <CIR²=20Mbps, CIR²_{max}= 20Mbps, CBS²=8*(EVC Maximum Service Frame Size), EIR²=50Mbps, EIR²_{max}=0Mbps, EBS²=0, CM²=color blind, CF²=0, Envelope ID=U3_EPL2, Rank=2></p> <p>PCP = 1: <CIR¹=5Mbps, CIR¹_{max}= 20Mbps, CBS¹=40*(EVC Maximum Service Frame Size), EIR¹=0Mbps, EIR¹_{max}=50Mbps, EBS¹=0, CM¹=color blind, CF¹=0, Envelope ID=U3_EPL2, Rank=1></p> <p>CF⁰=0</p>	<p>Parameters</p> <p>2 Bandwidth Profile Flows = frames mapped based on Class of Service Identifier of PCP</p> <p>Class of Service Identifier value = 5 for CoS Name=Krypton Class of Service Identifier value = 1 for CoS Name=Neon</p> <p>PCP = 5: <CIR²=20 Mbps, CIR²_{max}= 20Mbps, CBS²= 8*(EVC Maximum Service Frame Size), EIR²=50Mbps, EIR²_{max}=0Mbps, EBS²=0, CM²=color blind, CF²=0, Envelope ID=U4_EPL2, Rank=2></p> <p>PCP = 1: CIR¹=5 Mbps, CIR¹_{max}= 20Mbps, CBS¹= 8*(EVC Maximum Service Frame Size), EIR¹=0 Mbps, EIR¹_{max}=50Mbps, EBS¹=40*(EVC Maximum Service Frame Size), CM¹=color blind, CF¹=0, Envelope ID=U4_EPL2, Rank=1></p> <p>CF⁰=0</p>
Egress Bandwidth Profile Per Equivalence Class	No	No
Source MAC Address Limit	Disabled	Disabled

EVC per UNI Service Attribute	UNI 3	UNI 4
Subscriber MEG MIP	Enabled	Enabled
Test MEG	Disabled	Disabled

Table 30: EVC per UNI attributes for Public Data Networking using EPL Service

[Table 31](#) provides the EVC attributes for the public data networking example.

EVC Service Attribute	EVC_1
EVC Type	Point-to-Point
EVC ID	EPL2
UNI List	{<U3, Role=Root>, <U4, Role=Root>}
Maximum Number of UNIs	2
Unicast Service Frame Delivery	Deliver Unconditionally
Multicast Service Frame Delivery	Deliver Unconditionally
Broadcast Service Frame Delivery	Deliver Unconditionally
CE-VLAN ID Preservation	Enabled
CE-VLAN CoS Preservation	Enabled
EVC Performance	CoS Name= Krypton CoS Name= Neon
EVC Maximum Service Frame Size	1600 (So, Untagged: 1596 & Tagged: 1600)

Table 31: EVC attributes for Public Data Networking using EPL Service

A.3. Example: Ethernet Private Tree (EP-Tree) Service for Video Broadcast

One example of using the EP-Tree Service is for a video broadcast application. In this scenario, we assume that a video broadcaster, as Subscriber, gets the EP-Tree Service from a Service Provider to deliver a video Service to its video customers. The EP-Tree Service associates Root UNIs at video headend locations with Leaf UNIs at video customer locations.

The video distribution Service might offer multiple broadcast channels. In the case where all channels are to be delivered to each of the video customers, this Service is mostly uni-directional (no or minimal signaling traffic from Leaf to Root). In this mode, more efficient Service delivery is possible compared to E-Line Service Type. Additionally, in the case when each video customer (connected to a Leaf UNI) needs just a subset of the available channels, then this might be configured via a standard multicast protocol. This example does not describe the use of multicast protocol to restrict the membership of a video customer to a specific channel group.

The Service architecture is illustrated in [Figure 16](#) below. The white dots represent Root UNIs and the red dots represent Leaf UNIs for this EVC.

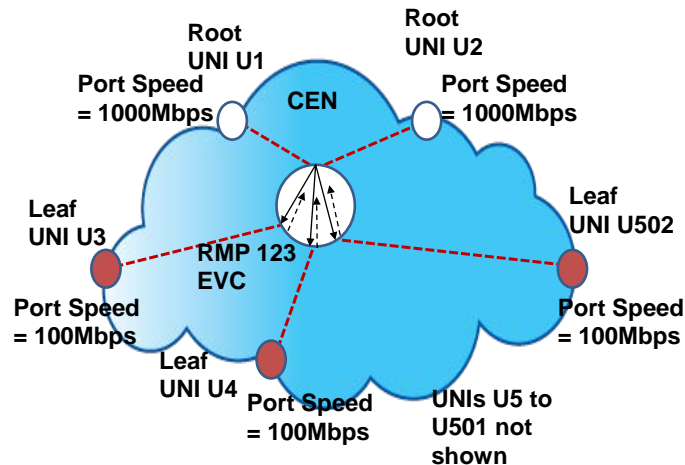

Figure 16: Example of Video Broadcast Delivery Using the EP-Tree Service

The majority of the traffic pattern is that the video content is sent from the video head-end towards the receiving video customer, while each such video customer might send minimal control messages to the video head-end.

In the case where the video broadcaster (Subscriber) wishes to have redundancy, two Root UNIs might be used with some redundancy protocol ensuring that only one of them transmits data into the EVC.

For this case the suggested UNI attributes are depicted in [Table 32](#).

UNI Service Attribute	Root UNIs (UNIs 1 & 2)	Leaf UNIs (UNIs 3 → 502)
UNI Identifier	U1 (primary), U2 (back-up)	U3 → U502
Physical Layer	{1000BASE-LX, 1000BASE-LX} Full Duplex Auto-negotiation: Disabled	{100BASE-TX} Full Duplex Auto-negotiation: Disabled
Synchronous Mode	{Disabled, Disabled}	{Disabled}
Number of Links	2	1
UNI Resiliency	2-Link Aggregation	None
Service Frame Format	IEEE Std 802.3 - 2012	IEEE Std 802.3 - 2012
UNI Maximum Service Frame Size	1522	1522
Service Multiplexing	Disabled	Disabled
CE-VLAN ID for untagged and priority tagged Service Frames	All CE-VLANs map to EVC RMP123	All CE-VLANs map to EVC RMP123
CE-VLAN ID/EVC Map	All CE-VLANs mapped to RMP123	All CE-VLANs mapped to RMP123
Maximum number of EVCs	1	1
Bundling	Disabled	Disabled
All to One Bundling	Enabled	Enabled
Token Share	Disabled	Disabled
Envelopes	{} Empty list since one flow at each UNI	{} Empty list since one flow at each UNI
Ingress Bandwidth Profile Per UNI	No	No
Egress Bandwidth Profile Per UNI	No	No
Link OAM	Enabled	Enabled
UNI MEG	Disabled	Disabled
E-LMI	Disabled	Disabled
UNI L2CP Address Set	CTB	CTB
UNI L2CP Peering	{LACP/LAMP, Link OAM}	{Link OAM}

Table 32: UNI attributes for the video broadcast example using EP-Tree Service

Table 33 provides the EVC per UNI attributes for the video broadcast example.

EVC per UNI Service Attribute	Root UNIs (UNIs 1 & 2)	Leaf UNIs (UNIs 3 → 502)
UNI EVC ID	U1_RMP123, U2_RMP123	U3_RMP123, ... U502_RMP123
Class of Service Identifier for Data Service Frame	Class of Service Identifier mechanism= EVC CoS Name= Krypton Class of Service Identifier value = EVC ID	Class of Service Identifier mechanism= EVC CoS Name= Krypton Class of Service Identifier value = EVC ID
Class of Service Identifier for L2CP Service Frame	Class of Service Identifier mechanism = treated like Data Service Frames CoS Name= Krypton Class of Service Identifier values = {list ¹¹ of Protocols used by Subscriber}	Class of Service Identifier mechanism = treated like Data Service Frames CoS Name= Krypton Class of Service Identifier values = {list ¹¹ of Protocols used by Subscriber}
Class of Service Identifier for SOAM Service Frame	CoS Name= Krypton Class of Service Identifier = same as Data Service Frames	CoS Name= Krypton Class of Service Identifier= same as Data Service Frames
Color ID for Service Frame	None	None
Egress Equivalence Class for Data Service Frame	Mechanism= All PCP values in EVC (No impact since no Egress Bandwidth Profile)	Mechanism= All PCP values in EVC (No impact since no Egress Bandwidth Profile)
Egress Equivalence Class for L2CP Service Frame	Not Specified (Since no Egress Bandwidth Profile)	Not Specified (Since no Egress Bandwidth Profile)
Egress Equivalence Class for SOAM Service Frame	All PCP values in EVC (No impact since no Egress Bandwidth Profile)	All PCP values in EVC (No impact since no Egress Bandwidth Profile)
Ingress Bandwidth Profile Per EVC	No ¹²	No

¹² Video source might be considered trusted and constant bit rate.

EVC per UNI Service Attribute	Root UNIs (UNIs 1 & 2)	Leaf UNIs (UNIs 3 → 502)
Ingress Bandwidth Profile Per Class of Service Identifier	No ¹²	<p>Parameters</p> <p>1 Bandwidth Profile Flow at <u>each Leaf UNI</u>= Frames mapped based on Class of Service Identifier=EVC</p> <p>Class of Service Identifier mechanism = EVC for CoS Name = Krypton</p> <p><CIR¹=1 Mbps¹³, CIR¹_{max}=1000Mbps, CBS¹=8*(EVC Maximum Service Frame Size), EIR¹=0, EIR¹_{max}=1000Mbps, EBS¹=0, CM¹=color blind, CF¹=0></p> <p><CIR¹=1 Mbps¹³, CIR¹_{max}=1000Mbps, CBS¹=8*(EVC Maximum Service Frame Size), EIR¹=0, EIR¹_{max}=1000Mbps, EBS¹=0, CM¹=color blind, CF¹=0></p> <p>:</p> <p>: for all Leaf UNIs in EVC</p> <p>:</p> <p><CIR¹=1 Mbps¹³, CIR¹_{max}=1000Mbps, CBS¹=8*(EVC Maximum Service Frame Size), EIR¹=0, EIR¹_{max}=1000Mbps, EBS¹=0, CM¹=color blind, CF¹=0></p> <p>ERⁱ is not included in Parameters since one flow per Envelope</p>
Egress Bandwidth Profile Per EVC	No	No

¹³ Minimal traffic from Leaf to Root.

EVC per UNI Service Attribute	Root UNIs (UNIs 1 & 2)	Leaf UNIs (UNIs 3 → 502)
Egress Bandwidth Profile Per Equivalence Class	No	No
Source MAC Address Limit	Disabled	Disabled
Subscriber MEG MIP	Disabled	Disabled
Test MEG	Disabled	Disabled

Table 33: EVC per UNI attributes for the video broadcast example using EP-Tree Service

[Table 34](#) provides the EVC attributes for the video broadcast example.

EVC Service Attribute	EVC_1
EVC Type	Rooted-Multipoint
EVC ID	RMP123
UNI List	{<U1, Role=Root>, <U2, Role=Root>, <U3, Role=Leaf>, <U4, Role=Leaf>/.../<U502, Role=Leaf>}
Maximum Number of UNIs	1000 ¹⁴
Unicast Service Frame Delivery	Deliver Conditionally
Multicast Service Frame Delivery	Deliver Conditionally: only deliver content subscribed to on a given Leaf UNI
Broadcast Service Frame Delivery	Deliver Unconditionally
CE-VLAN ID Preservation	Enabled
CE-VLAN CoS Preservation	Enabled
EVC Performance (for all ordered UNI pairs where at least one UNI in each pair is of Type Root).	CoS Name = Krypton
EVC Maximum Service Frame Size	1522 (So, Untagged: 1518 & Tagged: 1522)

Table 34: EVC Service Attributes for the video broadcast example using EP-Tree Service

A.4. Example: Distance Learning (EVP-Tree) and Business Data (EVP-LAN)

In this example, we build a more complex scenario of an E-Tree Type of Service and overlay it with an E-LAN Type of Service. All Subscriber locations are connected with two EVCs: EVP-LAN Service is used for a business data application, and EVP-tree Service is used for a distance learning application, which is based on IP video.

Since the same UNIs are used for both Services, Service Multiplexing is required at each UNI,

¹⁴ 1000 allows for up to 498 more UNIs (Leaf or Root UNIs) that can be added to this EVC

and separate bandwidth profiles are needed to ensure that the Services do not adversely affect each other. For the E-LAN Service Type, bundling is required to ensure CE-VLAN ID transparency in the range indicated in Table 36. For the E-Tree Service Type, bundling is not required since only one CE-VLAN is mapped to that EVC. [Figure 17](#) below shows this example. The white dots represent Root UNIs (U1 and U2) for both EVCs. The red dots represent Leaf UNIs (U3-U50) for the RMP333 EVC but the blue dots represent the Root UNIs (U3-U50) for the MP111 EVC. Each EVC has a single Class of Service, Neon for MP111 and Krypton for RMP333.

This example also shows the use of attributes like Subscriber MEG. For example, a Subscriber MEG MIP can be offered on one EVC but not offered on another EVC at the same UNI.

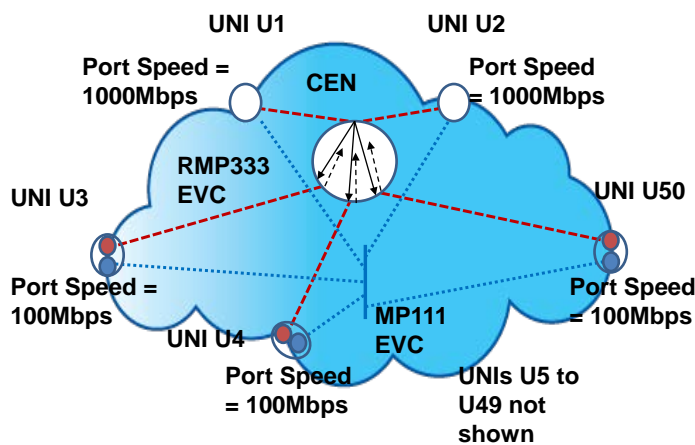

Figure 17: Example of Distance Learning and Business Data Using EVP-LAN and EVP-Tree Services

The suggested UNI attributes are shown in [Table 35](#) below.

UNI Service Attribute	UNIs 1 & 2	UNIs 3 → 50
UNI Identifier	U1, U2	U3 → U50
Physical Layer	{1000BASE-T, 1000BASE-T} Full Duplex Auto-negotiation: Enabled (Speed values of 10/100/1000)	{100BASE-TX} Full Duplex Auto-negotiation: Disabled
Synchronous Mode	{Disabled, Disabled}	{Disabled}
Number of Links	2	1
UNI Resiliency	2-Link Aggregation	None
Service Frame Format	IEEE Std 802.3 - 2012	IEEE Std 802.3 - 2012
UNI Maximum Service Frame Size	1522	1522
Service Multiplexing	Enabled	Enabled
CE-VLAN ID for untagged and priority tagged Service Frames	7 ¹⁵	7 ¹⁵
CE-VLAN ID / EVC Map	11-3999: MP111 4000: RMP333	11-3999: MP111 4000: RMP333
Maximum number of EVCs	10	5
Bundling	Enabled	Enabled
All to One Bundling	Disabled	Disabled
Token Share	Disabled	Disabled
Envelopes	{} Empty list since one flow per Envelope at U1 and U2	{} Empty list since one flow per Envelope at each of U3...U50 UNIs
Ingress Bandwidth Profile Per UNI	No	No
Egress Bandwidth Profile Per UNI	No	No
Link OAM	Disabled	Disabled
UNI MEG	Enabled	Enabled
E-LMI	Disabled	Disabled
UNI L2CP Address Set	CTA	CTA
UNI L2CP Peering	{LACP/LAMP}	{} Empty set since no protocols are Peered

Table 35: UNI attributes for the distance learning, business data example

The suggested EVC per UNI attributes are shown in Table 36 below. For table simplicity, only UNI 1 and UNI 50 are shown. It is expected that attributes for UNI 1 and 2 are similar and that UNIs 3-50 are similar to each other.

¹⁵ In this example, MP111 has CE-VLAN Preservation attribute set to Enabled (See [Table 37](#)). Thus, the value for CE-VLAN ID for untagged and priority tagged Service Frames attribute is chosen to not map the frames to MP111. Note also that RMP333 service requires one CE-VLAN ID in the service.

EVC per UNI Service Attribute		UNIs 1 & 2 (Values shown for UNI1)		UNIs 3-50 (Values shown for UNI50)	
		EVC_1 MP111	EVC_2 RMP333	EVC_1 MP111	EVC_2 RMP333
UNI EVC ID		U1_MP111	U1_RMP333	U50_MP111	U50_RMP333
Class of Service Identifier for Data Service Frame	CoS Name	Neon	Krypton	Neon	Krypton
	Class of Service Identifier mechanism	EVC	EVC	EVC	EVC
	Class of Service Identifier value	MP111	RMP333	MP111	RMP333
Class of Service Identifier for L2CP Service Frame	CoS Name	Neon	Krypton	Neon	Krypton
	Class of Service Identifier mechanism	Treated same as Data Service Frame	Treated same as Data Service Frame	Treated same as Data Service Frame	Treated same as Data Service Frame
	Class of Service Identifier values	{list ¹¹ of Protocols used by Subscriber}	{list ¹¹ of Protocols used by Subscriber}	{list ¹¹ of Protocols used by Subscriber}	{list ¹¹ of Protocols used by Subscriber}
Class of Service Identifier for SOAM Service Frame	CoS Name	Same as Data Service Frame		Same as Data Service Frame	
	Class of Service Identifier mechanism				
	Class of Service Identifier value				
Color ID for Service Frame		None (since color blind Bandwidth Profile)		None (since color blind Bandwidth Profile)	
Egress Equivalence Class for Data Service Frame	Equivalence Class	EEC-Neon	EEC-Krypton	EEC-Neon	EEC-Krypton
	Equivalence Class mechanism	CE-VLAN CoS with all PCP values	CE-VLAN CoS with all PCP values	CE-VLAN CoS with all PCP values	CE-VLAN CoS with all PCP values
	Equivalence Class value	MP111	RM333	MP111	RMP333
Egress Equivalence Class for L2CP Service Frame	Equivalence Class	EEC-Neon	EEC-Krypton	EEC-Neon	EEC-Krypton
	Equivalence Class mechanism	Treated same as Data Service Frame	Treated same as Data Service Frame	Treated same as Data Service Frame	Treated same as Data Service Frame
	Equivalence Class values	{list ¹¹ of Protocols used by Subscriber}	{list ¹¹ of Protocols used by Subscriber}	{list ¹¹ of Protocols used by Subscriber}	{list ¹¹ of Protocols used by Subscriber}
Egress Equivalence Class for SOAM Service Frame	Equivalence Class	Same as Data Service Frame		Same as Data Service Frame	
	Equivalence Class mechanism				
	Equivalence Class value				

EVC per UNI Service Attribute		UNIs 1 & 2 (Values shown for UNI1)		UNIs 3-50 (Values shown for UNI50)	
		EVC_1 MP111	EVC_2 RMP333	EVC_1 MP111	EVC_2 RMP333
Ingress Bandwidth Profile Per EVC		No		No	
Egress Bandwidth Profile per EVC		No		No	
Ingress Bandwidth Profile Per Class of Service Identifier	Bandwidth Profile Flows	1	1	1	1
	CoS Name	Neon	Krypton	Neon	Krypton
	Class of Service Identifier value	See above for Data Service Frame	See above for Data Service Frame	See above for Data Service Frame	See above for Data Service Frame
	CIR ¹ (Mbps)	20	10	20	1
	CIR ¹ max (Mbps)	1000	1000	1000	1000
	CBS ¹ (B)	35 * (EVC Maximum Service Frame Size)	15 * (EVC Maximum Service Frame Size)	35 * (EVC Maximum Service Frame Size)	15 * (EVC Maximum Service Frame Size)
	EIR ¹ (Mbps)	20	0	20	0
	EIR ¹ max (Mbps)	1000	1000	1000	1000
	EBS ¹ (B)	35 * (EVC Maximum Service Frame Size)	0	50 * (EVC Maximum Service Frame Size)	0
	CM ¹	Color Blind	Color Blind	Color Blind	Color Blind
	CF ¹	0	0	0	0
	Envelope ID	ER ¹ is not included in Parameters since one flow per Envelope			
Rank	ER ¹ is not included in Parameters since one flow per Envelope				
Egress Bandwidth Profile Per Egress Equivalence Class	Bandwidth Profile Flows	1	1	1	1
	Egress Equivalence Class	EEC-Neon	EEC-Krypton	EEC-Neon	EEC-Krypton
	Equivalence Class value	See above for Data Service Frame	See above for Data Service Frame	See above for Data Service Frame	See above for Data Service Frame
	CIR ¹ (Mbps)	20	10	20	1
	CIR ¹ max (Mbps)	1000	1000	1000	1000

EVC per UNI Service Attribute		UNIs 1 & 2 (Values shown for UNI1)		UNIs 3-50 (Values shown for UNI50)	
		EVC_1 MP111	EVC_2 RMP333	EVC_1 MP111	EVC_2 RMP333
	CBS ¹ (B)	50 * (EVC Maximum Service Frame Size)	15 * (EVC Maximum Service Frame Size)	50 * (EVC Maximum Service Frame Size)	10 * (EVC Maximum Service Frame Size)
	EIR ¹ (Mbps)	20	0	20	0
	EIR ¹ max (Mbps)	1000	1000	1000	1000
	EBS ¹ (B)	70* (EVC Maximum Service Frame Size)	0	70* (EVC Maximum Service Frame Size)	0
	CM ¹	Color Blind	Color Blind	Color Blind	Color Blind
	CF ¹	0	0	0	0
	Envelope ID	ER ⁱ is not included in Parameters since one flow per Envelope			
	Rank	ER ⁱ is not included in Parameters since one flow per Envelope			
Source MAC Address Limit	Disabled	Disabled	Disabled	Enabled N=5 $\tau=24$ hrs	
Subscriber MEG MIP	Enabled	Disabled	Enabled	Disabled	
Test MEG	Disabled		Disabled		

Table 36: EVC per UNI attributes for the distance learning, business data example

The suggested EVC Service Attributes and parameter values are shown in [Table 37](#) below for each of the EVCs in this example.

EVC Service Attribute	EVC-1	EVC_2
EVC Type	Multipoint-to-Multipoint	Rooted-Multipoint
EVC ID	MP111	RMP333
UNI List	{<U1, Role=Root>, <U2, Role=Root>, /.../ <U50, Role=Root>}	{<U1, Role=Root>, <U2, Role=Root>, <U3, Role=Leaf>, /.../ <U50, Role=Leaf>}
Maximum Number of UNIs	100	100
Unicast Service Frame Delivery	Deliver Conditionally: for known Destination MAC Addresses only to destination UNI and subject to dynamic learning and filtering process as described in IEEE Std 802.1Q-2011 [1]; for unknown Destination MAC Addresses, deliver unconditionally to all destination UNIs	Deliver Conditionally: for known Destination MAC Addresses only to destination UNI and subject to dynamic learning and filtering process as described in IEEE Std 802.1Q-2011 [1]; for unknown Destination MAC Addresses, deliver unconditionally to all destination UNIs
Multicast Service Frame Delivery	Deliver Unconditionally	Deliver Conditionally: only deliver content subscribed to on a given Leaf UNI
Broadcast Service Frame Delivery	Deliver Unconditionally	Deliver Unconditionally
CE-VLAN ID Preservation	Enabled	Disabled
CE-VLAN CoS Preservation	Enabled	Disabled
EVC Performance	CoS Name = Neon (for all ordered UNI pairs)	CoS Name = Krypton (for all ordered UNI pairs where at least one UNI in each pair is of Type Root)
EVC Maximum Service Frame Size	1522 (So, Untagged: 1518 & Tagged: 1522)	1522 (So, Untagged: 1518 & Tagged: 1522)

Table 37: EVC attributes for the distance learning, business data example

Appendix B. Backwards Compatibility to MEF 6.1 Service

MEF 6.2 Services use attributes and parameters specified in MEF 10.3 [6] and Multi-CEN L2CP [17] with additional constraints specified for some of the attributes as described in Section 8 and 10 of this document. This section provides guidance on identifying the parameter values that can be set for a MEF 6.2 service such that the Subscriber sees similar behavior as for a MEF 6.1 [4] Service.

The following tables also identify the Service specific constraints such as Egress Bandwidth Profile. Most of the other Service specific constraints are as defined in Section 10 of this document. Where necessary, explanation has been included to support the backwards compatibility for MEF 6.1 Service.

UNI Service Attribute	Values specified in MEF 10.3 and used for MEF 6.2 Service	Value for MEF 6.1 Service
UNI ID	<i>String</i> as specified in Section 9.1 of MEF 10.3 [6].	Name change: UNI Identifier in MEF 6.1. Value change: Type of characters allowed
Physical Layer	<i>List of Physical Layers</i> as specified in Section 9.2 of MEF 10.3 [6].	List of 1 Physical Layer Speed values limited to those specified in IEEE Std 802.3-2005 Speed & Full Duplex Mode: part of specifying Physical Layer.
Synchronous Mode	<i>List of Disabled</i> or <i>Enabled</i> for each link in the UNI as specified in Section 9.3 of MEF 10.3 [6].	Not specified in MEF 6.1 [4]. Any value can be used.
Number of Links	<i>At least 1</i> as Section 9.4 of MEF 10.3 [6].	Not specified in MEF 6.1 [4]. Any value can be used.
UNI Resiliency	<i>None</i> or <i>2-link Aggregation</i> or <i>Other</i> as specified in Section 9.5 of MEF 10.3 [6].	Not specified in MEF 6.1 [4]. Any value can be used.
Service Frame Format	<i>IEEE Std 802.3 – 2012</i> as specified in Section 9.6 of MEF 10.3 [6].	Name change: MAC Layer in MEF 6.1 Value change: IEEE Std 802.3-2005 Untagged Service Frame is Frame that includes Type other than x81-00. S-Tagged Frame behavior is unspecified.
UNI Maximum Service Frame Size	<i>At least 1522</i> as specified in Section 9.7 of MEF 10.3 [6].	Not specified in MEF 6.1 [4]. Any value can be used. Attribute: MTU in MEF 6.1 [4]. Value change: format dependent, i.e., Untagged Frames can be at least 1518B and Tagged Frames can be at least 1522B
Service Multiplexing	<i>Enabled</i> or <i>Disabled</i> as specified in Section 9.8 of MEF 10.3 [6].	No change see Service specific Tables
CE-VLAN ID for Untagged and Priority Tagged Service Frames	<i>A value in the range 1 to 4094</i> as specified in Section 9.9 of MEF 10.3 [6].	No change see Service specific Tables When All to one Bundling is Enabled then this can be Not Applicable
CE-VLAN ID/EVC Map	<i>A map</i> as specified in Section 9.10 of MEF 10.3 [6].	No change (for a given EVC) see Service specific Tables Changed to ‘per UNI’ attribute instead of ‘EVC per UNI’ attribute.
Maximum number of EVCs	<i>At least 1</i> as specified in Section 9.11 of MEF 10.3 [6].	No change see Service specific Tables
Bundling	<i>Enabled</i> or <i>Disabled</i> as specified in Section 9.12 of MEF 10.3 [6].	No change see Service specific Tables
All to One Bundling	<i>Enabled</i> or <i>Disabled</i> as specified in Section 9.13 of MEF 10.3 [6].	No change see Service specific Tables

UNI Service Attribute	Values specified in MEF 10.3 and used for MEF 6.2 Service	Value for MEF 6.1 Service
Token Share	<i>Enabled or Disabled</i> as specified in Section 8.2.1 of this document	Not specified in MEF 6.1 [4] . <i>Disabled.</i>
Envelopes	<i>list of <Envelope ID, n, CF⁰></i> as specified in Section 8.2.1 of this document.	Not specified in MEF 6.1 [4] . empty <i>list</i> (see [R5] in this document)
Ingress Bandwidth Profile Per UNI	<i>No</i> or <i>Parameters</i> as specified in Section 9.14 of MEF 10.3 [6] .	<i>No</i> or <i>Parameters</i> with values $n = 1$, $CIR_{max}^1 \geq CIR^1$, and $EIR_{max}^1 \geq EIR^1 + (CF^1 \times CIR^1)$ (see Section 12.2 of MEF 10.3 [6]) <i>No</i> when Bandwidth Profile per EVC or per Class of Service Identifier is used
Egress Bandwidth Profile Per UNI	<i>No</i> or <i>Parameters</i> as specified in Section 9.15 of MEF 10.3 [6] .	<i>No</i> or <i>Parameters</i> with values $n = 1$, $CIR_{max}^1 \geq CIR^1$, and $EIR_{max}^1 \geq EIR^1 + (CF^1 \times CIR^1)$ (see Section 12.2 of MEF 10.3 [6]) <i>No</i> when Bandwidth Profile per EVC or per Class of Service Identifier is used
Link OAM	<i>Enabled or Disabled</i> as specified in Section 9.16 of MEF 10.3 [6]	Not specified in MEF 6.1 [4] . Any value can be used.
UNI MEG	<i>Enabled or Disabled</i> as specified in Section 9.17 of MEF 10.3 [6]	Not specified in MEF 6.1 [4] . Any value can be used.
E-LMI	<i>Enabled or Disabled</i> as specified in Section 9.18 of MEF 10.3 [6]	Not specified in MEF 6.1 [4] . Any value can be used
UNI L2CP Address Set	See Multi-CEN L2CP [17]	See Multi-CEN L2CP [17]
UNI L2CP Peering	See Multi-CEN L2CP [17]	See Multi-CEN L2CP [17]

Table 38: UNI Service Attribute values for MEF 6.1 Service

EVC per UNI Service Attribute	Values specified in MEF 10.3 and used for MEF 6.2 Service	Value for MEF 6.1 Service
UNI EVC ID	<i>String</i> as specified in Section 10.1 of MEF 10.3 [6]	Value change: Type of characters allowed
Class of Service Identifier for Data Service Frame	<i>EVC</i> or <i>CE-VLAN CoS</i> or <i>IP</i> as specified in Section 10.2.1 of MEF 10.3 [6]	exclude DSCP in IPv6 when Class of Service Identifier is <i>IP</i> same Class of Service Identifier at all UNIs in the EVC Changed to EVC per UNI attribute instead of per EVC attribute in MEF 6.1
Class of Service Identifier for L2CP Service Frame	<i>“All”</i> or <i>list of each L2CP in the EVC and corresponding CoS Name</i> as specified in Section 10.2.2 of MEF 10.3 [6]	Value: No change same Class of Service Identifier at all UNIs in the EVC
Class of Service Identifier for SOAM Service Frame	<i>Basis same as for Data Service Frames</i> as specified in Section 10.2.3 of MEF 10.3[6]	No change from Section 9 of MEF 6.1 same Class of Service Identifier at all UNIs in the EVC
Color Identifier for Service Frame	<i>None</i> or <i>EVC</i> or <i>CE-VLAN CoS</i> or <i>CE-VLAN Tag DEI</i> or <i>IP</i> as specified in Section 10.3 of MEF 10.3 [6]	Not specified in MEF 6.1 [4]. Any value can be used.
Egress Equivalence Class Identifier for Data Service Frames	<i>CE-VLAN CoS</i> or <i>IP</i> as specified in Section 10.4.1 of MEF 10.3 [6]	Not specified in MEF 6.1 [4]. Identical to the Class of Service Identifier for Data Service Frames when the basis of the Class of Service Identifier is CE-VLAN CoS or IP. When the Class of Service Identifier is based on EVC, make the Egress Equivalence Class Identifier based on CE-VLAN CoS with all values of CE-VLAN CoS map to the same Class of Service Name as that mapped to by the EVC. [Note Egress Equivalence Class Identifier does not have EVC as one of the basis values] Name Change: Class of Service Identifier in MEF 6.1
Egress Equivalence Class Identifier for L2CP Service Frames	<i>“All”</i> or <i>list of each L2CP in the EVC and corresponding Egress Equivalence Class</i> as specified in Section 10.4.2 of MEF 10.3 [6]	Not specified in MEF 6.1 [4] Identical to the Class of Service Identifier for L2CP Service Frames. See Class of Service Identifier for L2CP Service Frame

EVC per UNI Service Attribute	Values specified in MEF 10.3 and used for MEF 6.2 Service	Value for MEF 6.1 Service
Egress Equivalence Class Identifier for SOAM Service Frames	<i>Basis same as for Data Service Frames</i> as specified in Section 10.4.3 of MEF 10.3[6]	Not specified in MEF 6.1 [4] Identical to the Class of Service Identifier for L2CP Service Frames. See Class of Service Identifier for SOAM Service Frame
Ingress Bandwidth Profile per EVC	<i>No or Parameters</i> as specified in Section 10.5 of MEF 10.3[6]	<i>No or Parameters</i> with values $n = 1$, $CIR_{max}^1 \geq CIR^1$, and $EIR_{max}^1 \geq EIR^1 + (CF^1 \times CIR^1)$ (see Section 12.2 of MEF 10.3 [6]) <i>No</i> when Bandwidth Profile per UNI or per Class of Service Identifier is used
Egress Bandwidth Profile per EVC	<i>No or Parameters</i> as specified in Section 10.6 of MEF 10.3[6]	<i>No or Parameters</i> with values $n = 1$, $CIR_{max}^1 \geq CIR^1$, and $EIR_{max}^1 \geq EIR^1 + (CF^1 \times CIR^1)$ (see Section 12.2 of MEF 10.3 [6]) <i>No</i> when Bandwidth Profile per UNI or per Class of Service Identifier is used see in Service specific Tables - Egress Bandwidth Profile per Egress Equivalence Class with CE-VLAN CoS of all PCP values mapping to a single Egress Equivalence Class for a given EVC
Ingress Bandwidth Profile per Class of Service Identifier	<i>No or Parameters</i> with Bandwidth Profile as defined in Section 10.6 of MEF 10.3 [6]	<i>No or Parameters</i> with values $n = 1$, $CIR_{max}^1 \geq CIR^1$, and $EIR_{max}^1 \geq EIR^1 + (CF^1 \times CIR^1)$ (see Section 12.2 of MEF 10.3 [6]) <i>No</i> when Bandwidth Profile per UNI or per EVC is used

EVC per UNI Service Attribute	Values specified in MEF 10.3 and used for MEF 6.2 Service	Value for MEF 6.1 Service
Egress Bandwidth Profile per Egress Equivalence Class	<i>No</i> or Parameters with Bandwidth Profile as defined in Section 10.8 of MEF 10.3 [6]	<i>No</i> or <i>Parameters</i> with values $n = 1$, $CIR_{max}^1 \geq CIR^1$, and $EIR_{max}^1 \geq EIR^1 + (CF^1 \times CIR^1)$ (see Section 12.2 of MEF 10.3 [6]) <i>No</i> when Bandwidth Profile per UNI or per EVC is used Name change: Egress Bandwidth Profile per Class of Service Identifier in MEF 6.1 see Service specific Tables
Source MAC Address Limit	Enabled or Disabled as specified in Section 10.9 of MEF 10.3 [6]	Not specified in MEF 6.1 [4]. Any value can be used.
Test MEG	Enabled or Disabled as specified in Section 10.10 of MEF 10.3 [6]	Not specified in MEF 6.1 [4]. Any value can be used.
Subscriber MEG MIP	Enabled or Disabled as specified in Section 10.11 of MEF 10.3 [6]	<i>Enabled</i> or <i>Disabled</i>

Table 39: EVC Per UNI Service Attribute values for MEF 6.1 Service

In Table 40, the EVC L2CP Processing Service Attribute, specified for a MEF 6.1 Service [4], is not included since this attribute is not used for a MEF 6.2 Service specified in this document. See Multi-CEN L2CP [17] for backwards compatibility to MEF 6.1.1 [5].

EVC Service Attribute	Values specified in MEF 10.3 and used for MEF 6.2 Service	Value for MEF 6.1 Service
EVC Type	<i>Point-to-Point</i> or <i>Multipoint-to-Multipoint</i> or <i>Rooted-Multipoint</i> as specified in Section 8.1 of MEF 10.3 [6]	No change see Service specific Tables
EVC ID	<i>String</i> as specified in Section 8.2 of MEF 10.3 [6]	Value change: Type of characters allowed
UNI List	<i>list of <UNI ID, UNI Role> pairs</i> as specified in Section 8.3 of MEF 10.3 [6] for UNIs associated by the EVC	No change Name change: UNI Role is UNI Type in MEF 6.1 see Service specific Tables
Maximum Number of UNIs	<i>two</i> or <i>three</i> or <i>greater</i> as specified in Section 8.4 of MEF 10.3 [6]	No change see Service specific Tables
Unicast Service Frame Delivery	<i>Discard</i> or <i>Deliver Unconditionally</i> or <i>Deliver Conditionally</i> as specified in Section 8.5.2 of MEF 10.3 [6]	No change <i>Unconditionally</i> includes constraints for Rooted Multipoint see Service specific Tables
Multicast Service Frame Delivery	<i>Discard</i> or <i>Deliver Unconditionally</i> or <i>Deliver Conditionally</i> as specified in Section 8.5.2 of MEF 10.3 [6]	No change <i>Unconditionally</i> includes constraints for Rooted Multipoint see Service specific Tables
Broadcast Service Frame Delivery	<i>Discard</i> or <i>Deliver Unconditionally</i> or <i>Deliver Conditionally</i> as specified in Section 8.5.2 of MEF 10.3 [6]	No change <i>Unconditionally</i> includes constraints for Rooted Multipoint see Service specific Tables
CE-VLAN ID Preservation	<i>Enabled</i> or <i>Disabled</i> as specified in Section 8.6.1 of MEF 10.3 [6]	Do not map the CE-VLAN ID for Untagged and Priority Tagged Service Frames to an EVC when All to One Bundling is Disabled and CE-VLAN ID Preservation is Enabled. see Service specific Tables
CE-VLAN CoS Preservation	<i>Enabled</i> or <i>Disabled</i> as specified in Section 8.6.2 of MEF 10.3 [6]	No change see Service specific Tables
EVC Performance	<i>A list of performance metrics and associated parameters</i> as specified in Section 8.8 of MEF 10.3 [6]	N/S for [new Performance metrics in MEF 10.3] see Service specific Tables
EVC Maximum Service Frame Size	<i>At least 1522</i> as specified in Section 8.9 of MEF 10.3 [6]	Not specified in MEF 6.1 [4]. Any value can be used Attribute: MTU in MEF 6.1 [4]. Value change: format dependent, i.e., Untagged Frames can be at least 1518B and Tagged Frames can be at least 1522B

Table 40: EVC Service Attribute values for MEF 6.1 Service

Appendix C. Attribute Tables per Service

This appendix has the service attributes and possible values for each Service specified in this document. This is based on Service definitions in sections 8 and 10 for the Service Types identified in section 9. The values in sections 8 and 10 prevail in case of any discrepancy between an attribute's values in this appendix and that of sections 8 and 10. Additionally, the definition of each attribute is per MEF 10.3 [6].

The “Desirable” value, if specified for an attribute, is formatted as bold font style. For instance, E-LMI attribute can have one of two values, “*Disabled* or *Enabled*”; however, the desired value, for this attribute, as per this document, is “*Disabled*” and, therefore, it is written as: “***Disabled*** or *Enabled*”.

C.1. UNI Service Attributes for all Services

UNI Service Attribute	EPL/EP-LAN/EP-Tree	EVPL/EVP-LAN/EVP-Tree
UNI ID	<i>String</i>	<i>String</i>
Physical Layer	<i>list of Physical Layers</i>	<i>list of Physical Layers</i>
Synchronous Mode	<i>list of Disabled or Enabled for each link in the UNI</i>	<i>list of Disabled or Enabled for each link in the UNI</i>
Number of Links	<i>At least 1</i>	<i>At least 1</i>
UNI Resiliency	<i>None or 2-link Aggregation or other</i>	<i>None or 2-link Aggregation or other</i>
Service Frame Format	<i>IEEE Std 802.3 – 2012</i>	<i>IEEE Std 802.3 – 2012</i>
UNI Maximum Service Frame Size	<i>At least 1522</i>	<i>At least 1522</i>
Service Multiplexing	<i>Disabled</i>	<i>Enabled or Disabled</i>
CE-VLAN ID for Untagged and Priority Tagged Service Frames	Not applicable for Service with All to One Bundling set to Enabled	<i>a value in the range 1 to 4094</i>
CE-VLAN ID/EVC Map	All CE-VLAN IDs map to the EVC	<i>At least 1 CE-VLAN ID maps to the EVC.</i>
Maximum number of EVCs	<i>1</i>	<i>At least 1</i>
Bundling	<i>Disabled</i>	<i>Enabled or Disabled</i>
All to One Bundling	<i>Enabled</i>	<i>Disabled</i>
Token Share	<i>Enabled or Disabled</i>	<i>Enabled or Disabled</i>
Envelopes	<i>list of <Envelope ID, CF⁰, n></i>	<i>list of <Envelope ID, CF⁰, n></i>
Ingress Bandwidth Profile Per UNI	<i>No</i>	<i>No</i>
Egress Bandwidth Profile Per UNI	<i>No</i>	<i>No</i>
Link OAM	<i>Disabled or Enabled</i>	<i>Disabled or Enabled</i>
UNI MEG	<i>Enabled or Disabled</i>	<i>Enabled or Disabled</i>
E-LMI	<i>Disabled or Enabled</i>	<i>Disabled or Enabled</i>
UNI L2CP Address Set	See Multi-CEN L2CP [17]	See Multi-CEN L2CP [17]
UNI L2CP Peering	See Multi-CEN L2CP [17]	See Multi-CEN L2CP [17]

Table 41: Per UNI attributes and values

C.2. EVC Per UNI Service Attributes for all Services

EVC per UNI Service Attribute	EPL	EVPL	EP-LAN/EVP-LAN EP-Tree/EVP-Tree
UNI EVC ID	<i>String</i>	<i>String</i>	<i>String</i>
Class of Service Identifier for Data Service Frame	<i>EVC or CE-VLAN CoS or IP value(s) and corresponding CoS Name</i>	<i>EVC or CE-VLAN CoS or IP value(s) and corresponding CoS Name</i>	<i>EVC or CE-VLAN CoS or IP value(s) and corresponding CoS Name</i>
Class of Service Identifier for L2CP Service Frame	<i>“All” or list of each L2CP in the EVC and corresponding CoS Name</i>	<i>“All” or list of each L2CP in the EVC and corresponding CoS Name</i>	<i>“All” or list of each L2CP in the EVC and corresponding CoS Name</i>
Class of Service Identifier for SOAM Service Frame	<i>Basis same as for Data Service Frames</i>	<i>Basis same as for Data Service Frames</i>	<i>Basis same as for Data Service Frames</i>
Color Identifier for Service Frame	<i>None or EVC or CE-VLAN CoS or CE-VLAN Tag DEI or IP</i>	<i>None or EVC or CE-VLAN CoS or CE-VLAN Tag DEI or IP</i>	<i>None or EVC or CE-VLAN CoS or CE-VLAN Tag DEI or IP</i>
Egress Equivalence Class Identifier for Data Service Frames	<i>CE-VLAN CoS or IP value(s) and corresponding Egress Equivalence Class</i>	<i>CE-VLAN CoS or IP value(s) and corresponding Egress Equivalence Class</i>	<i>CE-VLAN CoS or IP value(s) and corresponding Egress Equivalence Class</i>
Egress Equivalence Class Identifier for L2CP Service Frames	<i>“All” or list of each L2CP in the EVC and corresponding Egress Equivalence Class</i>	<i>“All” or list of each L2CP in the EVC and corresponding Egress Equivalence Class</i>	<i>“All” or list of each L2CP in the EVC and corresponding Egress Equivalence Class</i>
Egress Equivalence Class Identifier for SOAM Service Frames	<i>Basis same as for Data Service Frames</i>	<i>Basis same as for Data Service Frames</i>	<i>Basis same as for Data Service Frames</i>
Ingress Bandwidth Profile per EVC	<i>No</i>	<i>No</i>	<i>No</i>
Egress Bandwidth Profile per EVC	<i>No</i>	<i>No</i>	<i>No</i>
Ingress Bandwidth Profile per Class of Service Identifier	<i>Enabled or Disabled</i>	<i>Enabled or Disabled</i>	<i>Enabled or Disabled</i>
Egress Bandwidth Profile per Egress Equivalence Class	<i>No</i>	<i>Enabled or Disabled</i>	<i>Enabled or Disabled</i>
Source MAC Address Limit	<i>Disabled</i>	<i>Disabled</i>	<i>Enabled or Disabled</i>
Test MEG	<i>Enabled or Disabled</i>	<i>Enabled or Disabled</i>	<i>Enabled or Disabled</i>
Subscriber MEG MIP	<i>Enabled or Disabled</i>	<i>Enabled or Disabled</i>	<i>Enabled or Disabled</i>

Table 42: EVC Per UNI attributes and values

C.3. EVC Service Attributes for all Services

EVC Service Attribute	EPL	EP - LAN	EP - Tree	EVPL	EVP - LAN	EVP - Tree
EVC Type	<i>Point-to-Point</i>	<i>Multipoint-to-Multipoint</i>	<i>Rooted - Multipoint</i>	<i>Point-to-Point</i>	<i>Multipoint-to-Multipoint</i>	<i>Rooted - Multipoint</i>
EVC ID	<i>String</i>	<i>String</i>	<i>String</i>	<i>String</i>	<i>String</i>	<i>String</i>
UNI List	<i>list of <UNI ID, UNI Role=Root> pairs</i>	<i>list of <UNI ID, UNI Role=Root> pairs</i>	<i>list of <UNI ID, UNI Role> pairs</i>	<i>list of <UNI ID, UNI Role=Root> pairs</i>	<i>list of <UNI ID, UNI Role=Root> pairs</i>	<i>list of <UNI ID, UNI Role> pairs</i>
Maximum Number of UNIs	<i>Two</i>	≥ 3	≥ 3	<i>Two</i>	≥ 3	≥ 3
Unicast Service Frame Delivery	<i>Unconditional or Conditional</i>	<i>Unconditional or Conditional</i>	<i>Unconditional or Conditional</i>	<i>Unconditional or Conditional</i>	<i>Unconditional or Conditional</i>	<i>Unconditional or Conditional</i>
Multicast Service Frame Delivery	<i>Unconditional or Conditional</i>	<i>Unconditional or Conditional</i>	<i>Unconditional or Conditional</i>	<i>Unconditional or Conditional</i>	<i>Unconditional or Conditional</i>	<i>Unconditional or Conditional</i>
Broadcast Service Frame Delivery	<i>Unconditional or Conditional</i>	<i>Unconditional or Conditional</i>	<i>Unconditional or Conditional</i>	<i>Unconditional or Conditional</i>	<i>Unconditional or Conditional</i>	<i>Unconditional or Conditional</i>
CE-VLAN ID Preservation	<i>Enabled</i>	<i>Enabled</i>	<i>Enabled</i>	<i>Enabled or Disabled</i>	<i>Enabled or Disabled</i>	<i>Enabled or Disabled</i>
CE-VLAN CoS Preservation	<i>Enabled</i>	<i>Enabled</i>	<i>Enabled</i>	<i>Enabled or Disabled</i>	<i>Enabled or Disabled</i>	<i>Enabled or Disabled</i>
EVC Performance	<i>A list of performance metrics and associated parameters and performance objectives</i>	<i>A list of performance metrics and associated parameters and performance objectives</i>	<i>A list of performance metrics and associated parameters and performance objectives</i>	<i>A list of performance metrics and associated parameters and performance objectives</i>	<i>A list of performance metrics and associated parameters and performance objectives</i>	<i>A list of performance metrics and associated parameters and performance objectives</i>
EVC Maximum Service Frame Size	<i>At least 1522</i>	<i>At least 1522</i>	<i>At least 1522</i>	<i>At least 1522</i>	<i>At least 1522</i>	<i>At least 1522</i>

Table 43: Per EVC attributes and values