

MEF

Technical Specification

MEF 24

Abstract Test Suite for UNI Type 2

Part 2: E-LMI

May, 2009

Disclaimer

The information in this publication is freely available for reproduction and use by any recipient and is believed to be accurate as of its publication date. Such information is subject to change without notice and the MEF (Metro Ethernet Forum) is not responsible for any errors. The MEF does not assume responsibility to update or correct any information in this publication. No representation or warranty, expressed or implied, is made by the MEF concerning the completeness, accuracy, or applicability of any information contained herein and no liability of any kind shall be assumed by the MEF as a result of reliance upon such information.

The information contained herein is intended to be used without modification by the recipient or user of this document. The MEF is not responsible or liable for any modifications to this document made by any other party.

The receipt or any use of this document or its contents does not in any way create, by implication or otherwise:

(a) any express or implied license or right to or under any patent, copyright, trademark or trade secret rights held or claimed by any MEF member company which are or may be associated with the ideas, techniques, concepts or expressions contained herein; nor

(b) any warranty or representation that any MEF member companies will announce any product(s) and/or service(s) related thereto, or if such announcements are made, that such announced product(s) and/or service(s) embody any or all of the ideas, technologies, or concepts contained herein; nor

(c) any form of relationship between any MEF member companies and the recipient or user of this document.

Implementation or use of specific Metro Ethernet standards or recommendations and MEF specifications will be voluntary, and no company shall be obliged to implement them by virtue of participation in the MEF. The MEF is a non-profit international organization whose mission is to accelerate the worldwide adoption of Carrier-class Ethernet networks and services. The MEF does not, expressly or otherwise, endorse or promote any specific products or services.

© The Metro Ethernet Forum 2009. All Rights Reserved.

Table of Contents

1. ABSTRACT	6
2. TERMINOLOGY	6
3. SCOPE.....	7
4. COMPLIANCE LEVELS	7
5. INTRODUCTION	7
6. TEST CONFIGURATIONS FOR UNI-C TYPE 2 E-LMI	8
7. TEST CONFIGURATIONS FOR UNI-N TYPE 2 E-LMI	8
8. TESTING METHODOLOGY	9
9. TEMPLATE FOR ABSTRACT TEST CASES FOR UNI TYPE 2 E-LMI.....	10
10. TEST STATUS DEFINITIONS.....	11
11. TEST CASES SUMMARY.....	11
12. ABSTRACT TEST CASES FOR UNI-C TYPE 2 E-LMI.....	15
12.1 E-LMI FRAMING MECHANISM.....	16
TEST CASE 1C: E-LMI Frame Destination Address	16
TEST CASE 2C: E-LMI Frame Ethertype	17
TEST CASE 3C: E-LMI Frame Source Address.....	18
12.2 E-LMI MESSAGES	19
TEST CASE 4C: General Message Format.....	19
TEST CASE 5C: Order of Appearance of Information Elements	20
TEST CASE 7C: Information Elements Reserved Bits.....	21
TEST CASE 18C: Protocol Version.....	22
12.3 E-LMI PROCEDURES.....	23
TEST CASE 30C: Periodic Transmission of STATUS ENQUIRY	23
TEST CASE 31C: UNI-C Polling - Full Status.....	24
TEST CASE 36C: UNI-C Parsing and Configuration Update – Full Status	25
TEST CASE 37C: UNI-C Parsing and Configuration Update – Full Status Continued	26
TEST CASE 38C: UNI-C Sending <i>Full Status Continued</i> STATUS ENQUIRY	27
TEST CASE 39C: UNI-C Polling Timer Restart	28
TEST CASE 40C: UNI-C EVC Reference ID Comparison	29
TEST CASE 41C: Sequence Counter Increment - Send Sequence Number Field.....	30
TEST CASE 42C: Sequence Counter Increment - Receive Sequence Number Field.....	31
TEST CASE 43C: Send Sequence Counter - Zero Value Skipped	32
TEST CASE 48C: UNI-C Initialization - Data Instance	33
TEST CASE 49C: UNI-C Initialization - Report Type	34
TEST CASE 50C: UNI-C Receiving <i>Full Status</i> or <i>Full Status Continued</i> Reports.....	35
TEST CASE 51C: Polling Timer (PT) Expiry.....	36
TEST CASE 52C: Receipt of STATUS Message with DI Mismatch	37
TEST CASE 61C: <i>Full Status</i> STATUS Message Receipt - Add EVC	38
TEST CASE 62C: <i>Full Status Continued</i> STATUS Message Receipt - Add EVC.....	39
12.4 E-LMI IMPAIRMENTS.....	40
TEST CASE 64C: Order of Appearance of Information Elements – Protocol Version & Message Type.....	40
TEST CASE 65C: Order of Appearance of Information Elements – Report Type & Sequence Number	41
TEST CASE 66C: Invalid Receive Sequence Number.....	42
TEST CASE 67C: Active EVC Becoming Not Active	43

TEST CASE 68C: Partially Active EVC Becoming Not Active	44
TEST CASE 69C: <i>Full Status</i> STATUS Message Receipt - Replace EVC	45
TEST CASE 70C: <i>Full Status Continued</i> STATUS Message Receipt - Replace EVC	46
TEST CASE 72C: Abnormal Expiration of the Polling Timer – Full Status	47
TEST CASE 73C: Abnormal Expiration of the Polling Timer – Full Status Continued	48
TEST CASE 74C: E-LMI Check in Response to Full Status	49
TEST CASE 75C: E-LMI Check in Response to Full Status Continued	50
TEST CASE 76C: Receipt of an unsolicited E-LMI Check STATUS message	51
TEST CASE 77C: Receipt of an unsolicited Full Status STATUS message	52
TEST CASE 78C: Receipt of an unsolicited Full Status Continued STATUS message	53
TEST CASE 79C: Lower-Valued EVC Reference ID – Full Status	54
TEST CASE 80C: Lower-Valued EVC Reference ID – Full Status Continued	55
TEST CASE 81C: EVC Not Currently Defined	56
TEST CASE 82C: Protocol Version Error	57
TEST CASE 83C: Message Too Short	58
TEST CASE 84C: Message Type Errors	59
TEST CASE 85C: Missing Mandatory Information Elements	60
TEST CASE 86C: Duplicated Information Element	61
TEST CASE 87C: Duplicated Sub-Information Element	62
TEST CASE 88C: Mandatory Information Element Error	63
TEST CASE 89C: Unexpected Recognized Information Element	64
TEST CASE 90C: Status Counter Configuration	65
13. ABSTRACT TEST CASES FOR UNI-N TYPE 2 E-LMI.....	66
13.1 E-LMI FRAMING MECHANISM	67
TEST CASE 1N: E-LMI Frame Destination Address	67
TEST CASE 2N: E-LMI Frame Ethertype	68
TEST CASE 3N: E-LMI Frame Source Address	69
13.2 E-LMI MESSAGES	70
TEST CASE 4N: General Message Format	70
TEST CASE 5N: Order of Appearance of Information Elements	71
TEST CASE 6N: Order of Appearance of Sub-Information Elements	72
TEST CASE 7N: Information Elements Reserved Bits	73
TEST CASE 8N: STATUS message	74
TEST CASE 9N: STATUS Message - Single EVC	75
TEST CASE 10N: Structure of the STATUS Message - Sequence Numbers	76
TEST CASE 11N: Structure of the STATUS Message - Data Instance (DI)	77
TEST CASE 12N: Structure of the Full Status STATUS Message - EVC Status	78
TEST CASE 13N: Structure of the <i>Single EVC Asynchronous Status</i> STATUS Message - EVC Status	79
TEST CASE 14N: Structure of the STATUS Message - Full Status	80
TEST CASE 15N: Structure of the STATUS Message - Full Status Continued	81
TEST CASE 16N: Structure of the STATUS Message - Asynchronous Status	82
TEST CASE 17N: EVC Status and CE-VLAN ID/EVC Map Information Elements	83
TEST CASE 18N: Protocol Version	84
TEST CASE 19N: CE-VLAN ID/EVC Map IE - Default EVC Bit set to “0”	85
TEST CASE 20N: CE-VLAN ID/EVC Map IE - Sequence Number	86
TEST CASE 21N: EVC Status IE - Full Status & Full Status Continued	87
TEST CASE 22N: EVC Status IE - Single EVC Asynchronous Status	88
TEST CASE 23N: Data Instance IE - Reserved Value	89
TEST CASE 24N: EVC Map Entry Sub-Information Element	90
TEST CASE 25N: UNI Identifier Sub-Information Element - Undefined UNI Identifier	91
TEST CASE 26N: UNI Identifier Sub-Information Element - Defined UNI Identifier	92
TEST CASE 27N: EVC Identifier Sub-Information Element - Undefined EVC Identifier	93
TEST CASE 28N: EVC Identifier Sub-Information Element - Defined EVC Identifier	94
13.3 E-LMI PROCEDURES.....	95
TEST CASE 29N: STATUS ENQUIRY Message	95
TEST CASE 32N: UNI-N Response to a STATUS ENQUIRY Requesting Full Status	96
TEST CASE 33N: UNI-N <i>Full Status</i> STATUS Message - EVC Status IE	97
TEST CASE 34N: UNI-N <i>Full Status Continued</i> STATUS Message - EVC Status IE	98

TEST CASE 35N: UNI-N Response to a *Full Status Continued* STATUS ENQUIRY Message 99

TEST CASE 43N: Send Sequence Counter - Zero Value Skipped 100

TEST CASE 44N: UNI-N Receive and Send Sequence Counters 101

TEST CASE 45N: Asynchronous Status – Report Type 102

TEST CASE 46N: Asynchronous Status Message 103

TEST CASE 47N: Interval Between Single EVC Asynchronous Status Messages 104

TEST CASE 53N: Initial DI Value 105

TEST CASE 54N: UNI Change of Information 106

TEST CASE 55N: EVC Change of Information 107

TEST CASE 56N: *Full Status and Full Status Continued* reports DI value 108

TEST CASE 57N: E-LMI STATUS ENQUIRY with ELMi Check 109

TEST CASE 58N: Addition of a New EVC - Full Status Report 110

TEST CASE 59N: Addition of a New EVC - Full Status Continued Report 111

TEST CASE 60N: Addition of a New EVC “New” Bit Set to 1 112

TEST CASE 63N: Modification of an EVC Attribute “New” Bit Set to 0 113

13.4 E-LMI IMPAIRMENTS 114

TEST CASE 66N: Invalid Receive Sequence Number 114

TEST CASE 71N: Failure to Receive a STATUS ENQUIRY 115

TEST CASE 82N: Protocol Version Error 116

TEST CASE 83N: Message Too Short 117

TEST CASE 84N: Message Type Errors 118

TEST CASE 86N: Duplicated Information Element 119

TEST CASE 89N: Unexpected Recognized Information Element 120

TEST CASE 90N: Status Counter Configuration 121

TEST CASE 91N: Polling Verification Timer 122

TEST CASE 92N: Polling Verification Timer Disabled 123

14. REFERENCES 124

1. Abstract

This document is the second part of the Abstract Test Suite for User to Network Interface (UNI) Type 2. It defines test procedures based on a combination of requirements for E-LMI described in MEF 20 *User Network Interface (UNI) Type 2 Implementation Agreement* and in MEF 16 *Ethernet Local Management Interface*. The overall Abstract Test Suite for UNI Type 2 will be composed of the following parts: Link OAM, E-LMI, Service OAM, Protection, Enhanced UNI Attributes and L2CP handling.

2. Terminology

CE	Customer Edge
DI	Data Instance
EVC	Ethernet Virtual Connection
E-LMI	Ethernet Local Management Interface
MAC	Media Access Control
OAM	Operation Administration and Maintenance
PT	Polling Timer
PVT	Polling Verification Timer
TLV	Type, Length and Value
UNI	User to Network Interface. (The physical demarcation point between the responsibility of the Service Provider and the responsibility of the Subscriber)
UNI-C	User Network Interface C
UNI-N	User Network Interface N

3. Scope

The E-LMI part of the Abstract Test Suite for UNI Type 2 describes test procedures based on a combination of the requirements for E-LMI described in MEF 20 *User Network Interface (UNI) Type 2 Implementation Agreement* and in MEF 16 *Ethernet Local Management Interface*.

An overview of the different groups of requirements that compose E-LMI is provided as follows:

- E-LMI Framing Mechanisms
- E-LMI Messages
- E-LMI Procedures
- E-LMI Impairments

The UNI Type 2 Link OAM, Service OAM, Protection, Enhanced UNI Attributes and L2CP handling functionalities are outside the scope of this Abstract Test Suite.

This document may be updated in the future to reflect new work done in the MEF Technical Committee.

4. Compliance Levels

The key words “**MUST**”, “**MUST NOT**”, “**REQUIRED**”, “**SHALL**”, “**SHALL NOT**”, “**SHOULD**”, “**SHOULD NOT**”, “**RECOMMENDED**”, “**MAY**”, and “**OPTIONAL**” in this document are to be interpreted as described in RFC 2119. All key words **MUST** be use upper case, bold text.

5. Introduction

This document supplements the existing MEF test specifications MEF 9 *Abstract Test Suite for Ethernet Services at the UNI*, MEF 14 *Abstract Test Suite for Traffic Management Phase 1*, MEF 18 *Abstract Test Suite for Circuit Emulation Services*, MEF 19 *Abstract Test Suite for UNI Type 1* and MEF 21 *Abstract Test Suite for UNI Type 2 – Part 1: Link OAM* by adding test procedures based on the requirements for E-LMI defined in MEF 16 *Ethernet Local Management Interface* and in *User Network Interface (UNI) Type 2 Implementation Agreement*.

As with existing Abstract Test Suites, vendors can refer to the requirements and test procedures defined in this specification in the development and commercial cycles of their products and carriers can use them to ensure that the network elements they deploy or add to their existing network will have the ability to deliver Ethernet Services based on the MEF technical specifications.

The requirements, framework and functional model on how the UNI reference point operates in a Metro Ethernet Network is defined in the Metro Ethernet Forum technical specification MEF 11 *User to Network Interface Requirements and Framework*.

6. Test Configurations for UNI-C Type 2 E-LMI

Although some UNI-C Test Cases may require very specific test configurations, most UNI-C Test Cases defined in this document are to be executed using one of the two following Test Configurations. Tester 1, tester 2 and tester 3 may be combined into a single test device.

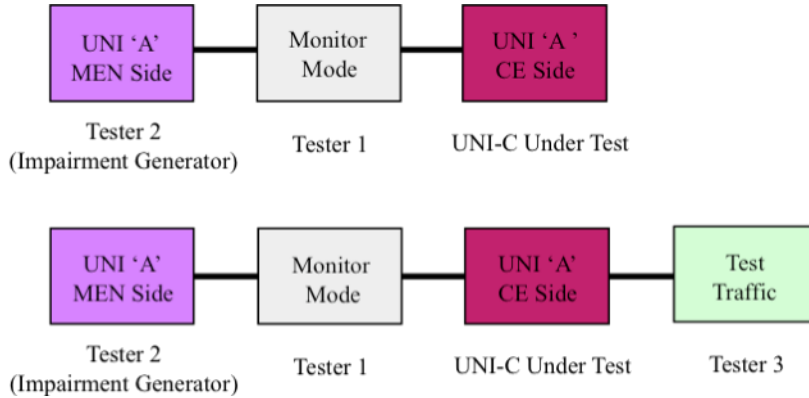

7. Test Configurations for UNI-N Type 2 E-LMI

Although some UNI-N Test Cases may require very specific test configurations, most UNI-N Test Cases defined in this document are to be executed using one of the two following Test Configurations. Tester 1, tester 2 and tester 3 may be combined into a single test device.

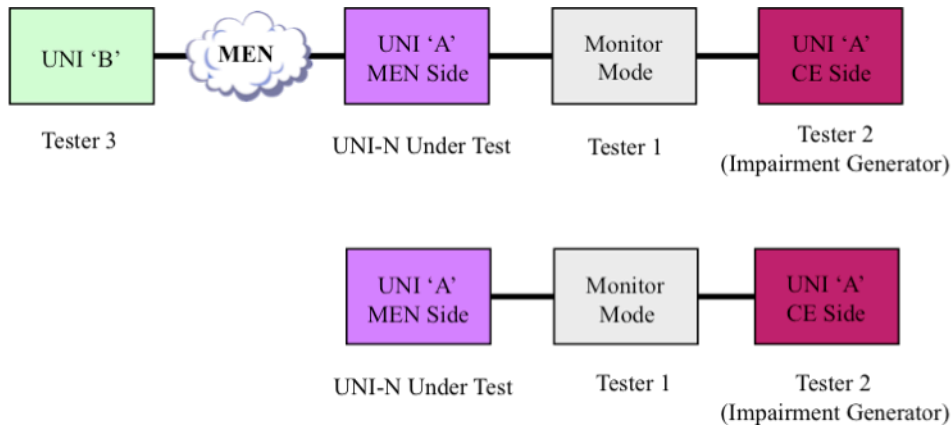

8. Testing Methodology

This document defines Test Cases for verifying the E-LMI protocol at the User Network Interface (UNI). The requirements and test procedures are derived from the Metro Ethernet Forum Technical Committee documents.

Vendors can refer to such requirements and test procedures in the development and commercial cycles of their products and carriers can refer to them to ensure that the Metro Ethernet systems they deploy in their network meet certain well-defined criteria.

Various types of criteria can be used to establish the test requirements. These criteria are conformance, performance, interoperability and functionality. The focus of this Abstract Test Suite is conformance.

Conformance Testing

Conformance testing consists of testing the extent to which a UNI-C or UNI-N conforms to the Technical Specification such as MEF 16, *Ethernet Local Management Interface*.

Conformance testing is extensive as it consists of testing against every feature and function defined in the specification.

Performance Testing

Performance testing evaluates an implementation under different traffic load and conditions to see how well it performs. Performance testing consists of measuring parameters that are traffic dependent under well-known traffic conditions.

Performance parameters are function related. It generally involves two functions: traffic generation and traffic analysis.

Interoperability Testing

Interoperability testing is used to measure the condition under which two or more systems with separate and different implementations will interoperate and produce the expected behavior. It involves testing both the capabilities and the behavior of an implementation in an interconnected environment and checking whether an implementation can interoperate with another implementation.

Functional Testing

The purpose of functional testing is to ensure that an implementation satisfies certain well-defined criteria some of which can be safely taken for granted and others of which it will be useful to test. Usually, these tests do not have a direct correspondence with the Protocol Implementation Conformance Statement (PICS).

Conformance, interoperability and functional test results are typically reported as “pass” or “fail” unless specified otherwise whereas performance test results are generally reported in terms of frame counts, times and rates.

9. Template for Abstract Test Cases for UNI Type 2 E-LMI

The following template is adopted for the definition of Abstract Test Cases for UNI Type 2 E-LMI

Abstract Test Suite for E-LMI																															
Test Name	Name derived from reference document																														
Test Definition ID	A punctuated alphanumeric string assigned to each defined requirement and test procedure couple using the following convention: Four characters defining the UNI type + four characters defining the Standard document on which the Abstract test Suite is based + 2 to 5 characters defining the section of the document where the requirement is described + 3 characters defining the UNI Type 2 requirement number. Example: UNIN-ELMI-5.2-R20 (UNIN: User Network Interface N under test, ELMI: E-LMI Technical Specification, 5.2: Section 5.2, R20: UNI Type 2 requirement 20)																														
Reference Document	Reference documents Names																														
Test Type	Functional, Conformance, Interoperability or Performance																														
Test Status	Mandatory, Optional or Recommended																														
Requirement Description	Brief description of the requirement that MUST or SHOULD be satisfied																														
Test Object	Succinct description of test purpose																														
Test Configuration	Succinct description of test bed configuration																														
Test Configuration Schematic	Test bed schematic. The variables can augment it																														
CE-VLAN ID/EVC Map	<table border="1" style="width: 100%; border-collapse: collapse;"> <thead> <tr> <th colspan="2" style="text-align: center;">UNI 'A'</th> <th colspan="2" style="text-align: center;">UNI 'B'</th> </tr> <tr> <th style="text-align: center;">CE-VLAN ID</th> <th style="text-align: center;">EVC</th> <th style="text-align: center;">CE-VLAN ID</th> <th style="text-align: center;">EVC</th> </tr> </thead> <tbody> <tr> <td style="text-align: center;">11*</td> <td style="text-align: center;">EVC₁</td> <td style="text-align: center;">11*</td> <td style="text-align: center;">EVC₁</td> </tr> </tbody> </table> <p>Use of other EVCs or CE-VLAN IDs is permitted provided that the configuration of the CE-VLAN ID/EVC Map conforms to MEF 10.1</p> <p>The CE-VLAN ID for untagged and priority tagged Service Frames is configured to 11 at both UNIs</p> <p>CE-VLAN ID/EVC Map. The variables can augment it</p>	UNI 'A'		UNI 'B'		CE-VLAN ID	EVC	CE-VLAN ID	EVC	11*	EVC ₁	11*	EVC ₁																		
UNI 'A'		UNI 'B'																													
CE-VLAN ID	EVC	CE-VLAN ID	EVC																												
11*	EVC ₁	11*	EVC ₁																												
Bandwidth Profile	<table border="1" style="width: 100%; border-collapse: collapse;"> <thead> <tr> <th colspan="5" style="text-align: center;">PER INGRESS UNI</th> </tr> <tr> <th style="text-align: center;">UNI</th> <th colspan="4" style="text-align: center;">Bandwidth Profile Parameters</th> </tr> <tr> <th style="text-align: center;">UNI</th> <th style="text-align: center;">CIR</th> <th style="text-align: center;">CBS</th> <th style="text-align: center;">EIR</th> <th style="text-align: center;">EBS</th> </tr> </thead> <tbody> <tr> <td colspan="5">Note 1: (0 < CIR < Ingress UNI Speed), (CBS ≥ maximum Service Frame size)</td> </tr> <tr> <td colspan="5">Note 2: (Ingress CIR ≤ Egress UNI Speed)</td> </tr> <tr> <td colspan="5">Note 3: (EIR ≥ 0) and (EBS ≥ 0)</td> </tr> </tbody> </table> <p>Bandwidth Profile. The variables can augment it</p>	PER INGRESS UNI					UNI	Bandwidth Profile Parameters				UNI	CIR	CBS	EIR	EBS	Note 1: (0 < CIR < Ingress UNI Speed), (CBS ≥ maximum Service Frame size)					Note 2: (Ingress CIR ≤ Egress UNI Speed)					Note 3: (EIR ≥ 0) and (EBS ≥ 0)				
PER INGRESS UNI																															
UNI	Bandwidth Profile Parameters																														
UNI	CIR	CBS	EIR	EBS																											
Note 1: (0 < CIR < Ingress UNI Speed), (CBS ≥ maximum Service Frame size)																															
Note 2: (Ingress CIR ≤ Egress UNI Speed)																															
Note 3: (EIR ≥ 0) and (EBS ≥ 0)																															
Test Procedure	Succinct description of the test procedure																														
Units	Units can be time units, rates and counts in integers such as milliseconds, frames per second and numbers of valid frames, etc																														
Variables	Variables such as number of UNIs, EVCs and CE-VLAN IDs and frame formats and lengths MUST be described																														
Results	Description of the textual, numerical and/or graphical format in which to display test results. Results can be Pass or Fail																														
Remarks	Description of any particular observations that might affect the test result																														

10. Test Status Definitions

MANDATORY status: This means that a test case **MUST** be executed because it verifies an absolute requirement or an absolute requirement dependent on an optional feature. If the requirement is absolute the test must be executed. If the requirement is absolute but dependent on an optional feature and that feature is supported, the test case must be executed. If the optional feature is not supported, the test case is not executed and it is declared as “not applicable”.

OPTIONAL status: This word means that a test case **MAY** or **MAY NOT** be executed because it verifies a requirement that is not absolute. The decision to execute such a test case will usually depend on the ability to support a particular feature that is not tied to an absolute requirement. If such a test case is not executed it is declared as “not applicable”.

11. Test Cases Summary

E-LMI Framing Mechanism

Number	Test Case Name	UNI Type	Test Status
1	E-LMI Frame Destination Address	UNI-C & UNI-N	Mandatory
2	E-LMI Frame Ethertype	UNI-C & UNI-N	Mandatory
3	E-LMI Frame Source Address	UNI-C & UNI-N	Mandatory

E-LMI Messages

Number	Test Case Name	UNI Type	Test Status
4	General Message Format	UNI-C & UNI-N	Mandatory
5	Order of Appearance of Information Elements	UNI-C & UNI-N	Mandatory
6	Order of Appearance of Sub-Information Elements	UNI-N	Mandatory
7	Information Elements Reserved Bits	UNI-C & UNI-N	Mandatory
8	STATUS Message	UNI-N	Mandatory
9	STATUS Message - Single EVC	UNI-N	Mandatory if <i>Single EVC Asynchronous Status Report Type</i> is supported
10	Structure of STATUS Message - Sequence Numbers	UNI-N	Mandatory
11	Structure of STATUS Message - Data Instance	UNI-N	Mandatory
12	Structure of the Full Status STATUS Message - EVC Status	UNI-N	Mandatory
13	Structure of the Single EVC Asynchronous Status STATUS Message - EVC Status	UNI-N	Mandatory if <i>Single EVC Asynchronous Status Report Type</i> is supported
14	Structure of STATUS Message - Full Status	UNI-N	Mandatory

15	Structure of STATUS Message - Full Status Continued	UNI-N	Mandatory
16	Structure of STATUS Message - Asynchronous Status	UNI-N	Mandatory if <i>Single EVC Asynchronous Status Report Type</i> is supported
17	EVC Status and CE-VLAN ID/EVC Map Information Elements	UNI-N	Mandatory
18	Protocol Version	UNI-C & UNI-N	Mandatory
19	CE-VLAN ID/EVC Map IE - Default EVC Bit Set to 0	UNI-N	Mandatory
20	CE-VLAN ID/EVC Map IE - Sequence Number	UNI-N	Mandatory if 64 EVCs and more are supported at the UNI
21	EVC Status IE - Full Status and Full Status Continued	UNI-N	Mandatory
22	EVC Status IE - Single EVC Asynchronous Status	UNI-N	Mandatory if <i>Single EVC Asynchronous Status Report Type</i> is supported
23	Data Instance IE - Reserved Value	UNI-N	Mandatory
24	EVC Map Entry Sub-Information Element	UNI-N	Mandatory
25	UNI Identifier Sub-Information Element - Undefined UNI Identifier	UNI-N	Mandatory
26	UNI Identifier Sub-Information Element - Defined UNI Identifier	UNI-N	Mandatory
27	EVC Identifier Sub-Information Element - Undefined EVC Identifier	UNI-N	Mandatory
28	EVC Identifier Sub-Information Element - Defined EVC Identifier	UNI-N	Mandatory

E-LMI Procedures

Number	Test Case Name	UNI-Type	Test Status
29	STATUS ENQUIRY Message	UNI-N	Mandatory
30	Periodic Transmission of STATUS ENQUIRY	UNI-C	Mandatory
31	UNI-C Polling - Full Status	UNI-C	Mandatory
32	UNI-N Response to a STATUS ENQUIRY Requesting Full Status	UNI-N	Mandatory
33	UNI-N Full Status STATUS Message - EVC Status IE	UNI-N	Mandatory
34	UNI-N Full Status Continued STATUS Message - EVC Status IE	UNI-N	Mandatory
35	UNI-N Response to a Full Status Continued STATUS ENQUIRY Message	UNI-N	Mandatory
36	UNI-C Parsing and Configuration Update – Full Status	UNI-C	Optional
37	UNI-C Parsing and Configuration Update – Full Status Continued	UNI-C	Optional
38	UNI-C Sending Full Status Continued STATUS ENQUIRY	UNI-C	Mandatory
39	UNI-C Polling Timer Restart	UNI-C	Mandatory
40	UNI-C EVC Reference ID Comparison	UNI-C	Mandatory if access to the UNI-C list of configured EVCs is possible
41	Sequence Counter Increment - Send Sequence Number Field	UNI-C	Mandatory
42	Sequence Counter Increment - Receive Sequence Number Field	UNI-C	Mandatory
43	Send Sequence Counter - Zero Value Skipped	UNI-C & UNI-N	Mandatory
44	UNI-N Receive and Send Sequence Counters	UNI-N	Mandatory
45	Asynchronous Status – Report Type	UNI-N	Optional

46	Asynchronous Status Message	UNI-N	Mandatory if <i>Single EVC Asynchronous Status Report Type</i> is supported
47	Interval Between Single EVC Asynchronous Status Messages	UNI-N	Optional
48	UNI-C Initialization - Data Instance	UNI-C	Mandatory
49	UNI-C Initialization - Report Type	UNI-C	Mandatory
50	UNI-C Receiving Full Status or Full Status Continued Reports	UNI-C	Mandatory
51	Polling Timer (PT) Expiry	UNI-C	Mandatory
52	Receipt of STATUS Message with DI Mismatch	UNI-C	Mandatory
53	Initial DI Value	UNI-N	Mandatory
54	UNI Change of Information	UNI-N	Mandatory
55	EVC Change of Information	UNI-N	Mandatory
56	Full Status and Full Status Continued Reports DI Value	UNI-N	Mandatory
57	E-LMI STATUS ENQUIRY with E-LMI Check	UNI-N	Mandatory
58	Addition of a New EVC - Full Status Report	UNI-N	Mandatory
59	Addition of a New EVC - Full Status Continued Report	UNI-N	Mandatory
60	Addition of a New EVC - New Bit set to 1	UNI-N	Mandatory
61	Full Status STATUS Message Receipt - Add EVC	UNI-C	Mandatory if access to the UNI-C list of configured EVCs is possible
62	Full Status Continued STATUS Message Receipt - Add EVC	UNI-C	Mandatory if access to the UNI-C list of configured EVCs is possible
63	Modification of an EVC Attribute - New Bit Set to 0	UNI-N	Mandatory

E-LMI Impairments

Number	Test Case Name	UNI Type	Test Status
64	Order of Appearance of Information Elements – Protocol Version & Message Type	UNI-C	Mandatory
65	Order of Appearance of Information Elements – Report Type & Sequence Number	UNI-C	Mandatory
66	Invalid Receive Sequence Number	UNI-C & UNI-N	Mandatory
67	Active EVC Becoming Not Active	UNI-C	Mandatory
68	Partially Active EVC Becoming Not Active	UNI-C	Mandatory
69	Full Status STATUS Message Receipt - Replace EVC	UNI-C	Mandatory if access to the UNI-C list of configured EVCs is possible
70	Full Status Continued STATUS Message Receipt - Replace EVC	UNI-C	Mandatory if access to the UNI-C list of configured EVCs is possible
71	Failure to Receive a STATUS ENQUIRY	UNI-N	Mandatory if the PVT and error indication are accessible
72	Abnormal Expiration of the Polling Timer – Full Status	UNI-C	Mandatory

73	Abnormal Expiration of the Polling Timer – Full Status Continued	UNI-C	Mandatory
74	E-LMI Check in Response to Full Status	UNI-C	Mandatory
75	E-LMI Check in Response to Full Status Continued	UNI-C	Mandatory
76	Receipt of an Unsolicited E-LMI Check STATUS Message	UNI-C	Mandatory
77	Receipt of an Unsolicited Full Status STATUS Message	UNI-C	Mandatory
78	Receipt of an Unsolicited Full Status Continued STATUS Message	UNI-C	Mandatory
79	Lower-Valued EVC Reference ID – Full Status	UNI-C	Mandatory if access to the UNI-C list of configured EVCs is possible
80	Lower-Valued EVC Reference ID – Full Status Continued	UNI-C	Mandatory if access to the UNI-C list of configured EVCs is possible
81	EVC Not Currently Defined	UNI-C	Mandatory if access to the UNI-C list of configured EVCs and list of errors is possible
82	Protocol Version Error	UNI-C & UNI-N	Mandatory
83	Message Too Short	UNI-C & UNI-N	Mandatory
84	Message Type Errors	UNI-C & UNI-N	Mandatory
85	Missing Mandatory Information Elements	UNI-C	Mandatory
86	Duplicated Information Element	UNI-C & UNI-N	Mandatory
87	Duplicated Sub-Information Element	UNI-C	Mandatory if access to the UNI-C local database is possible
88	Mandatory Information Element Error	UNI-C	Mandatory
89	Unexpected Recognized Information Element	UNI-C & UNI-N	Mandatory for UNI-N and Mandatory if access to the UNI-C local database is possible for UNI-C
90	Status Counter Configuration	UNI-C	Optional
91	Polling Verification Timer	UNI-N	Optional
92	Polling Verification Timer Disabled	UNI-N	Optional

12. Abstract Test Cases for UNI-C Type 2 E-LMI

This section contains a total of 50 Test Cases for UNI-C. It is divided in 4 different subsections as follows:

Section 12.1

E-LMI Framing Mechanism contains a total of 3 Test Cases that covers the requirements described in section 5.2 of MEF 16 Ethernet Local Management Interface and the requirement R20 of UNI Type 2 Implementation Agreement.

Section 12.2

E-LMI Messages contains a total of 4 Test Cases that covers the requirements described in section 5.5 of MEF 16 Ethernet Local Management Interface and the requirement R20 of UNI Type 2 Implementation Agreement.

Section 12.3

E-LMI Procedures contains a total of 17 Test Cases that covers the requirements described in section 5.6 of MEF 16 Ethernet Local Management Interface and the requirements R20 and R21 of UNI Type 2 Implementation Agreement.

Section 12.4

E-LMI Impairments contains a total of 26 Test Cases that covers the requirements described in sections 5.2 to 5.6 of MEF 16 Ethernet Local Management Interface and the requirements R20 and R21 of UNI Type 2 Implementation Agreement.

12.1 E-LMI Framing Mechanism

TEST CASE 1C: E-LMI Frame Destination Address

Abstract Test Suite for E-LMI - Framing Mechanisms	
Test Name	E-LMI Frame Destination Address
Test Definition ID	UNIC-ELMI-5.2-R20
Reference Document	MEF 20 UNI Type 2 Implementation Agreement Section 9 MEF 16 Ethernet Local Management Interface
Test Type	Conformance
Test Status	Mandatory
Requirement Description	The E-LMI frame destination address SHALL be 01-80-C2-00-00-07
Test Object	Verify that the E-LMI frame destination address is 01-80-C2-00-00-07
Test Configuration	Configure UNI "A" CE Side with the default value of N393. Configure UNI "A" MEN Side with the default values of N393 and T392. Tester 1 with proper PHYs that match the UNI "A" MEN side and CE side is monitoring the E-LMI frames
Test Configuration Schematic	<pre> graph LR T2[UNI 'A' MEN Side Tester 2 (Impairment Generator)] --- T1[Monitor Mode Tester 1] T1 --- U[UNI 'A' CE Side UNI-C Under Test] </pre>
CE-VLAN ID/EVC Map	Not Specified
Bandwidth Profile	Not Specified
Test Procedure	Restart the UNI "A" CE Side and use the tester 1 to monitor the E-LMI messages for a period of time ($T = 3 \times T391$). Verify that the destination address of the STATUS ENQUIRY messages sent by the UNI "A" CE Side (UNI-C) is set to 01-80-C2-00-00-07
Units	Destination address value
Variables	None
Results	Pass or fail
Remarks	Use of the address (01-80-C2-00-00-07) requires that there is no 802.1Q component between UNI-C and UNI-N. Test Case must be run using T391 in the range (5-30 seconds) and N391 in the range (1-65k). Suggested values for T391 = 5 and N391 = 2.

TEST CASE 2C: E-LMI Frame Ethertype

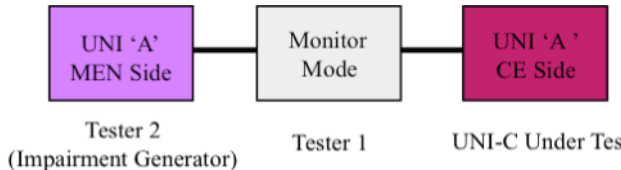
Abstract Test Suite for E-LMI - Framing Mechanisms	
Test Name	E-LMI Frame Ethertype
Test Definition ID	UNIC-ELMI-5.2-R20
Reference Document	MEF 20 UNI Type 2 Implementation Agreement Section 9 MEF 16 Ethernet Local Management Interface
Test Type	Conformance
Test Status	Mandatory
Requirement Description	The E-LMI frame Ethertype SHALL be 88-EE
Test Object	Verify that the E-LMI frame Ethertype is 88-EE
Test Configuration	Configure UNI "A" CE Side with the default value of N393. Configure UNI "A" MEN Side with the default values of N393 and T392. Tester 1 with proper PHYs that match the UNI "A" MEN side and CE side is monitoring the E-LMI frames
Test Configuration Schematic	 <pre> graph LR T2[Tester 2 (Impairment Generator)] --- U1[UNI 'A' MEN Side] U1 --- M[Monitor Mode Tester 1] M --- U2[UNI 'A' CE Side] U2 --- U3[UNI-C Under Test] </pre>
CE-VLAN ID/EVC Map	Not Specified
Bandwidth Profile	Not Specified
Test Procedure	Restart the UNI "A" CE Side and use the tester 1 to monitor the E-LMI messages for a period of time ($T = 3 \times T391$). Verify that the Ethertype of the STATUS ENQUIRY messages sent by the UNI "A" CE Side (UNI-C) is set to 88-EE
Units	Ethertype value
Variables	None
Results	Pass or fail
Remarks	Test Case must be run using T391 in the range (5-30 seconds) and N391 in the range (1-65k). Suggested values for T391 = 5 and N391 = 2

TEST CASE 3C: E-LMI Frame Source Address

Abstract Test Suite for E-LMI - Framing Mechanisms	
Test Name	E-LMI Frame Source Address
Test Definition ID	UNIC-ELMI-5.2-R20
Reference Document	MEF 20 UNI Type 2 Implementation Agreement Section 9 MEF 16 Ethernet Local Management Interface
Test Type	Conformance
Test Status	Mandatory
Requirement Description	The E-LMI frame source address SHALL be the MAC address of the sending station or port
Test Object	Verify that the E-LMI frame source address is the MAC address of the sending station or port
Test Configuration	Configure UNI "A" CE Side with the default value of N393. Configure UNI "A" MEN Side with the default values of N393 and T392. Tester 1 with proper PHYs that match the UNI "A" MEN side and CE side is monitoring the E-LMI frames
Test Configuration Schematic	<pre> graph LR T2[UNI 'A' MEN Side Tester 2 (Impairment Generator)] --- T1[Monitor Mode Tester 1] T1 --- U[UNI 'A' CE Side UNI-C Under Test] </pre>
CE-VLAN ID/EVC Map	Not Specified
Bandwidth Profile	Not Specified
Test Procedure	Restart the UNI "A" CE Side and use the tester 1 to monitor the E-LMI messages for a period of time ($T = 3 \times T391$). Verify that the source address of the STATUS ENQUIRY messages sent by the UNI "A" CE Side (UNI-C) is the MAC address of the sending station or port
Units	Source address value
Variables	None
Results	Pass or fail
Remarks	Test Case must be run using T391 in the range (5-30 seconds) and N391 in the range (1-65k). Suggested values for T391 = 5 and N391 = 2

12.2 E-LMI Messages

TEST CASE 4C: General Message Format

Abstract Test Suite for E-LMI - Messages	
Test Name	General Message Format
Test Definition ID	UNIC-ELMI-5.5.1-R20
Reference Document	MEF 20 UNI Type 2 Implementation Agreement Section 9 MEF 16 Ethernet Local Management Interface
Test Type	Conformance
Test Status	Mandatory
Requirement Description	The following parts of the E-LMI message (Protocol Version, Message Type and Report Type) SHALL always be present
Test Object	Verify that the following parts of the E-LMI message (Protocol Version, Message Type and Report Type) are always present
Test Configuration	Configure UNI "A" CE Side with the default value of N393. Configure UNI "A" MEN Side with the default values of N393 and T392. Tester 1 with proper PHYs that match the UNI "A" MEN side and CE side is monitoring the E-LMI frames
Test Configuration Schematic	<pre> graph LR T2[UNI 'A' MEN Side Tester 2 (Impairment Generator)] --- T1[Monitor Mode Tester 1] T1 --- UT[UNI 'A' CE Side UNI-C Under Test] </pre>
CE-VLAN ID/EVC Map	Not Specified
Bandwidth Profile	Not Specified
Test Procedure	During all the testing activities, use the Tester 1 to monitor the E-LMI messages. Verify that each STATUS ENQUIRY message transmitted by the UNI "A" CE side (UNI-C) contains the Protocol Version, Message Type and Report Type parts
Units	Protocol Version, Message Type and Report Type values
Variables	None
Results	Pass or fail
Remarks	Test Case must be run using T391 in the range (5-30 seconds) and N391 in the range (1-65k). Suggested values for T391 = 5 and N391 = 2

TEST CASE 5C: Order of Appearance of Information Elements

Abstract Test Suite for E-LMI - Messages													
Test Name	Order of Appearance of Information Elements												
Test Definition ID	UNIC-ELMI-5.5.1-R20												
Reference Document	MEF 20 UNI Type 2 Implementation Agreement Section 9 MEF 16 Ethernet Local Management Interface												
Test Type	Conformance												
Test Status	Mandatory												
Requirement Description	When there is more than one Information Element, the order of appearance of the Information Elements SHALL be based on the numerical value of the Information Elements identifiers with Information Elements with lower value identifiers appearing before those with higher value identifiers												
Test Object	Verify that in a message with more than one Information Element, Information Elements with lower value identifiers appear before those with higher value identifiers												
Test Configuration	At least one EVC is simulated by the tester 2 and at least one CE-VLAN ID is mapped to each EVC. A per Ingress UNI bandwidth profile is also simulated at the UNI "A". Configure UNI "A" CE Side with the default value of N393. Configure UNI "A" MEN Side with the default values of N393 and T392. Tester 1 with proper PHYs that match the UNI "A" MEN side and CE side is monitoring the E-LMI frames												
Test Configuration Schematic	<pre> graph LR T2[Tester 2 (Impairment Generator)] --- UAMEN[UNI 'A' MEN Side] UAMEN --- MM[Monitor Mode] MM --- UACE[UNI 'A' CE Side] UACE --- UC[UNI-C Under Test] </pre>												
CE-VLAN ID/EVC Map	<table border="1" style="width: 100%; border-collapse: collapse;"> <thead> <tr> <th colspan="2" style="text-align: center;">UNI 'A'</th> </tr> <tr> <th style="text-align: center;">CE-VLAN ID</th> <th style="text-align: center;">EVC</th> </tr> </thead> <tbody> <tr> <td style="text-align: center;">11*</td> <td style="text-align: center;">EVC₁</td> </tr> <tr> <td colspan="2">Use of other EVCs or CE-VLAN IDs is permitted provided that the configuration of the CE-VLAN ID/EVC Map conforms to MEF 10.1</td> </tr> <tr> <td colspan="2">The CE-VLAN ID for untagged and priority tagged Service Frames is configured to 11</td> </tr> </tbody> </table>	UNI 'A'		CE-VLAN ID	EVC	11*	EVC ₁	Use of other EVCs or CE-VLAN IDs is permitted provided that the configuration of the CE-VLAN ID/EVC Map conforms to MEF 10.1		The CE-VLAN ID for untagged and priority tagged Service Frames is configured to 11			
UNI 'A'													
CE-VLAN ID	EVC												
11*	EVC ₁												
Use of other EVCs or CE-VLAN IDs is permitted provided that the configuration of the CE-VLAN ID/EVC Map conforms to MEF 10.1													
The CE-VLAN ID for untagged and priority tagged Service Frames is configured to 11													
Bandwidth Profile	<table border="1" style="width: 100%; border-collapse: collapse;"> <thead> <tr> <th colspan="2" style="text-align: center;">PER INGRESS UNI</th> </tr> <tr> <th style="text-align: center;">UNI</th> <th style="text-align: center;">Bandwidth Profile Parameters</th> </tr> <tr> <th style="text-align: center;">UNI</th> <th style="text-align: center;">CIR CBS EIR EBS</th> </tr> </thead> <tbody> <tr> <td colspan="2">Note 1: (0 < CIR < Ingress UNI Speed), (CBS ≥ maximum Service Frame size)</td> </tr> <tr> <td colspan="2">Note 2: (Ingress CIR ≤ Egress UNI Speed)</td> </tr> <tr> <td colspan="2">Note 3: (EIR ≥ 0) and (EBS ≥ 0)</td> </tr> </tbody> </table>	PER INGRESS UNI		UNI	Bandwidth Profile Parameters	UNI	CIR CBS EIR EBS	Note 1: (0 < CIR < Ingress UNI Speed), (CBS ≥ maximum Service Frame size)		Note 2: (Ingress CIR ≤ Egress UNI Speed)		Note 3: (EIR ≥ 0) and (EBS ≥ 0)	
PER INGRESS UNI													
UNI	Bandwidth Profile Parameters												
UNI	CIR CBS EIR EBS												
Note 1: (0 < CIR < Ingress UNI Speed), (CBS ≥ maximum Service Frame size)													
Note 2: (Ingress CIR ≤ Egress UNI Speed)													
Note 3: (EIR ≥ 0) and (EBS ≥ 0)													
Test Procedure	Restart the UNI "A" CE Side and use the tester 1 to monitor the E-LMI messages for a period of time ($T = 3 \times T391$). Verify that in the STATUS ENQUIRY messages sent by the UNI "A" CE Side (UNI-C), the Information Elements with lower value identifiers appear before those with higher value identifiers												
Units	STATUS ENQUIRY messages Information Elements identifiers values												
Variables	None												
Results	Pass or fail												
Remarks	Test Case must be run using T391 in the range (5-30 seconds) and N391 in the range (1-65k). Suggested values for T391 = 5 and N391 = 2												

TEST CASE 7C: Information Elements Reserved Bits

Abstract Test Suite for E-LMI - Messages	
Test Name	Information Elements Reserved Bits
Test Definition ID	UNIC-ELMI-5.5.1-R20
Reference Document	MEF 20 UNI Type 2 Implementation Agreement Section 9 MEF 16 Ethernet Local Management Interface
Test Type	Conformance
Test Status	Mandatory
Requirement Description	When the description of the information elements contains reserve bits, these spare bits SHALL be set to "0"
Test Object	Verify that when the description of the information elements contains reserve bits, these spare bits are set to "0"
Test Configuration	Configure UNI "A" CE Side with the default value of N393. Configure UNI "A" MEN Side with the default values of N393 and T392. Tester 1 with proper PHYs that match the UNI "A" MEN side and CE side is monitoring the E-LMI frames
Test Configuration Schematic	<pre> graph LR T2[UNI 'A' MEN Side Tester 2 (Impairment Generator)] --- T1[Monitor Mode Tester 1] T1 --- UT[UNI 'A' CE Side UNI-C Under Test] </pre>
CE-VLAN ID/EVC Map	Not Specified
Bandwidth Profile	Not Specified
Test Procedure	Restart the UNI "A" CE Side and use the tester 1 to monitor the E-LMI messages for a period of time ($T = 3 \times T391$). Verify that the reserved bits of the Information Elements of the STATUS ENQUIRY messages sent by the UNI "A" CE Side (UNI-C) are set to "0"
Units	Reserved bits values
Variables	None
Results	Pass or fail
Remarks	Test Case must be run using T391 in the range (5-30 seconds) and N391 in the range (1-65k). Suggested values for T391 = 5 and N391 = 2

TEST CASE 18C: Protocol Version

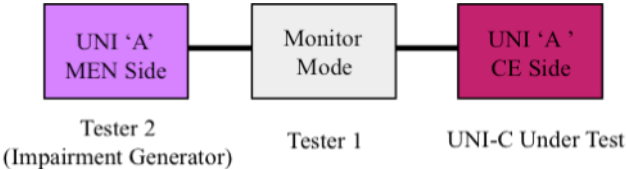
Abstract Test Suite for E-LMI - Messages	
Test Name	Protocol Version
Test Definition ID	UNIC-ELMI-5.5.3.1-R20
Reference Document	MEF 20 UNI Type 2 Implementation Agreement Section 9 MEF 16 Ethernet Local Management Interface
Test Type	Conformance
Test Status	Mandatory
Requirement Description	The Protocol Version field SHALL contain the value (00000001) to claim compliance with Version 1 of this protocol
Test Object	Verify that the Protocol Version field contains the value (00000001) to claim compliance with Version 1 of this protocol
Test Configuration	Configure UNI "A" CE Side with the default value of N393. Configure UNI "A" MEN Side with the default values of N393 and T392. Tester 1 with proper PHYs that match the UNI "A" MEN side and CE side is monitoring the E-LMI frames
Test Configuration Schematic	 <pre> graph LR T2[UNI 'A' MEN Side Tester 2 (Impairment Generator)] --- T1[Monitor Mode Tester 1] T1 --- T3[UNI 'A' CE Side UNI-C Under Test] </pre>
CE-VLAN ID/EVC Map	Not Specified
Bandwidth Profile	Not Specified
Test Procedure	Restart the UNI "A" CE Side and use the tester 1 to monitor the E-LMI messages for a period of time ($T = 3 \times T391$). Verify that the Protocol Version field of the STATUS ENQUIRY messages sent by the UNI "A" CE Side (UNI-C) contains the value (00000001)
Units	Protocol Version value
Variables	None
Results	Pass or fail
Remarks	Test Case must be run using T391 in the range (5-30 seconds) and N391 in the range (1-65k). Suggested values for T391 = 5 and N391 = 2

12.3 E-LMI Procedures

TEST CASE 30C: Periodic Transmission of STATUS ENQUIRY

Abstract Test Suite for E-LMI - Procedures	
Test Name	Periodic Transmission of STATUS ENQUIRY
Test Definition ID	UNIC-ELMI-5.6.2-R20
Reference Document	MEF 20 UNI Type 2 Implementation Agreement Section 9 MEF 16 Ethernet Local Management Interface
Test Type	Conformance
Test Status	Mandatory
Requirement Description	At least, every T391 seconds, the UNI-C SHALL send a STATUS ENQUIRY message to the UNI-N
Test Object	Verify that the UNI-C sends a STATUS ENQUIRY message to the UNI-N at least, every T391 seconds
Test Configuration	Configure UNI "A" CE Side with the default value of N393. Configure UNI "A" MEN Side with the default values of N393 and T392. Tester 1 with proper PHYs that match the UNI "A" MEN side and CE side is monitoring the E-LMI frames
Test Configuration Schematic	<pre> graph LR T2[UNI 'A' MEN Side Tester 2 (Impairment Generator)] --- T1[Monitor Mode Tester 1] T1 --- UCT[UNI 'A' CE Side UNI-C Under Test] </pre>
CE-VLAN ID/EVC Map	Not Specified
Bandwidth Profile	Not Specified
Test Procedure	Restart the UNI "A" CE Side and use the tester 1 to monitor the E-LMI messages for a period of time ($T = 5 \times T391$). Verify that the time interval between two STATUS ENQUIRY messages transmitted by the UNI "A" CE Side (UNI-C) is within $\pm 5\%$ of the value of T391 as measured by the tester.
Units	Seconds
Variables	T391
Results	Pass or fail
Remarks	Test Case must be run using T391 in the range (5-30 seconds) and N391 in the range (1-65k). Suggested values for T391 = 5 and 7 and N391 = 2

TEST CASE 31C: UNI-C Polling - Full Status

Abstract Test Suite for E-LMI - Procedures	
Test Name	UNI-C Polling - Full Status
Test Definition ID	UNIC-ELMI-5.6.2-R20
Reference Document	MEF 20 UNI Type 2 Implementation Agreement Section 9 MEF 16 Ethernet Local Management Interface
Test Type	Conformance
Test Status	Mandatory
Requirement Description	At least every N391 polling cycles, as measured by the Polling Counter, the UNI-C SHALL send a <i>Full Status</i> STATUS ENQUIRY. All other polls SHALL be report type equal <i>E-LMI Check</i>
Test Object	Verify that the UNI-C sends a <i>Full Status</i> STATUS ENQUIRY message to the UNI-N at least, every N391 polling cycles and that all other polls are <i>E-LMI Check</i> STATUS ENQUIRY messages
Test Configuration	Configure UNI "A" CE Side with the default value of N393. Configure UNI "A" MEN Side with the default values of N393 and T392. Tester 1 with proper PHYs that match the UNI "A" MEN side and CE side is monitoring the E-LMI frames
Test Configuration Schematic	<pre> graph LR T2[Tester 2 (Impairment Generator)] --- UAMEN[UNI 'A' MEN Side] UAMEN --- MM[Monitor Mode] MM --- UACE[UNI 'A' CE Side] subgraph Labels T2 --- T2L[Tester 2 (Impairment Generator)] MM --- T1[Tester 1] UACE --- UACEL[UNI-C Under Test] end </pre>
CE-VLAN ID/EVC Map	Not Specified
Bandwidth Profile	Not Specified
Test Procedure	Restart the UNI "A" CE Side and use the tester 1 to monitor the E-LMI messages for a period of time ($T = 5 \times N391 \times T391$). Verify that the UNI "A" CE Side (UNI-C) sends a <i>Full Status</i> STATUS ENQUIRY message to the UNI-N at least every N391 polling cycles and that all other polls are <i>E-LMI Check</i> STATUS ENQUIRY messages
Units	Number of <i>Full Status</i> and <i>E-LMI Check</i> STATUS ENQUIRY messages
Variables	N391
Results	Pass or fail
Remarks	Test Case must be run using T391 in the range (5-30 seconds) and N391 in the range (1-65k). Suggested values for T391 = 5 and N391 = 2 and 5

TEST CASE 36C: UNI-C Parsing and Configuration Update – Full Status

Abstract Test Suite for E-LMI - Procedures													
Test Name	UNI-C Parsing and Configuration Update – Full Status												
Test Definition ID	UNIC-ELMI-5.6.2-R21												
Reference Document	MEF 20 UNI Type 2 Implementation Agreement Section 9 MEF 16 Ethernet Local Management Interface												
Test Type	Conformance												
Test Status	Optional. Test is possible only if access to the UNI-C local database is possible												
Requirement Description	The UNI-C SHALL parse the STATUS message depending on the Report Type and if it receives a <i>Full Status</i> , or <i>Full Status Continued</i> STATUS message, it SHOULD update its configuration according to the status of the UNI and the status and service attributes of each configured EVC												
Test Object	Verify that the UNI-C parses the STATUS message depending on the Report Type and if it receives a <i>Full Status</i> STATUS message, it updates its configuration according to the status of the UNI and the status and service attributes of each configured EVC												
Test Configuration	At least one EVC is simulated by the tester 2 and at least one CE-VLAN ID is mapped to each EVC. A per Ingress UNI bandwidth profile is also simulated at the UNI "A". Configure UNI "A" CE Side with the default value of N393. Configure UNI "A" MEN Side with the default values of N393 and T392. Tester 1 with proper PHYs that match the UNI "A" MEN side and CE side is monitoring the E-LMI frames												
Test Configuration Schematic	<pre> graph LR T2[Tester 2 (Impairment Generator)] --- U1[UNI 'A' MEN Side] U1 --- M[Monitor Mode] M --- U2[UNI 'A' CE Side] U2 --- UCT[UNI-C Under Test] </pre>												
CE-VLAN ID/EVC Map	<table border="1" style="width: 100%; border-collapse: collapse;"> <thead> <tr> <th colspan="2" style="text-align: center;">UNI 'A'</th> </tr> <tr> <th style="width: 50%;">CE-VLAN ID</th> <th style="width: 50%;">EVC</th> </tr> </thead> <tbody> <tr> <td style="text-align: center;">11*</td> <td style="text-align: center;">EVC₁</td> </tr> <tr> <td colspan="2">Use of other EVCs or CE-VLAN IDs is permitted provided that the configuration of the CE-VLAN ID/EVC Map conforms to MEF 10.1</td> </tr> <tr> <td colspan="2">The CE-VLAN ID for untagged and priority tagged Service Frames is configured to 11</td> </tr> </tbody> </table>	UNI 'A'		CE-VLAN ID	EVC	11*	EVC ₁	Use of other EVCs or CE-VLAN IDs is permitted provided that the configuration of the CE-VLAN ID/EVC Map conforms to MEF 10.1		The CE-VLAN ID for untagged and priority tagged Service Frames is configured to 11			
UNI 'A'													
CE-VLAN ID	EVC												
11*	EVC ₁												
Use of other EVCs or CE-VLAN IDs is permitted provided that the configuration of the CE-VLAN ID/EVC Map conforms to MEF 10.1													
The CE-VLAN ID for untagged and priority tagged Service Frames is configured to 11													
Bandwidth Profile	<table border="1" style="width: 100%; border-collapse: collapse;"> <thead> <tr> <th colspan="2" style="text-align: center;">PER INGRESS UNI</th> </tr> <tr> <th style="width: 50%;">UNI</th> <th style="width: 50%;">Bandwidth Profile Parameters</th> </tr> </thead> <tbody> <tr> <td style="text-align: center;">UNI</td> <td style="text-align: center;">CIR CBS EIR EBS</td> </tr> <tr> <td colspan="2">Note 1: (0 < CIR < Ingress UNI Speed), (CBS ≥ maximum Service Frame size)</td> </tr> <tr> <td colspan="2">Note 2: (Ingress CIR ≤ Egress UNI Speed)</td> </tr> <tr> <td colspan="2">Note 3: (EIR ≥ 0) and (EBS ≥ 0)</td> </tr> </tbody> </table>	PER INGRESS UNI		UNI	Bandwidth Profile Parameters	UNI	CIR CBS EIR EBS	Note 1: (0 < CIR < Ingress UNI Speed), (CBS ≥ maximum Service Frame size)		Note 2: (Ingress CIR ≤ Egress UNI Speed)		Note 3: (EIR ≥ 0) and (EBS ≥ 0)	
PER INGRESS UNI													
UNI	Bandwidth Profile Parameters												
UNI	CIR CBS EIR EBS												
Note 1: (0 < CIR < Ingress UNI Speed), (CBS ≥ maximum Service Frame size)													
Note 2: (Ingress CIR ≤ Egress UNI Speed)													
Note 3: (EIR ≥ 0) and (EBS ≥ 0)													
Test Procedure	Restart the UNI "A" CE Side and use the tester 1 to monitor the E-LMI messages for a period of time ($T = 5 \times T391$). If access to the UNI "A" CE Side local database is possible, verify that upon receipt of a <i>Full Status</i> STATUS messages the UNI "A" CE side (UNI-C) updates its configuration according to the status of the UNI and the status and service attributes of each configured EVC												
Units	UNI "A" CE side configuration												
Variables	None												
Results	Pass or fail												
Remarks	Test Case must be run using T391 in the range (5-30 seconds) and N391 in the range (1-65k). Suggested values for T391 = 5 and N391 = 2												

TEST CASE 37C: UNI-C Parsing and Configuration Update – Full Status Continued

Abstract Test Suite for E-LMI - Procedures																															
Test Name	UNI-C Parsing and Configuration Update – Full Status Continued																														
Test Definition ID	UNIC-ELMI-5.6.2-R21																														
Reference Document	MEF 20 UNI Type 2 Implementation Agreement Section 9 MEF 16 Ethernet Local Management Interface																														
Test Type	Conformance																														
Test Status	Optional. Test is possible only if access to the UNI-C local database is possible																														
Requirement Description	The UNI-C SHALL parse the STATUS message depending on the Report Type and if it receives a <i>Full Status</i> , or <i>Full Status Continued</i> STATUS message, it SHOULD update its configuration according to the status of the UNI and the status and service attributes of each configured EVC																														
Test Object	Verify that the UNI-C parses the STATUS message depending on the Report Type and if it receives a <i>Full Status Continued</i> STATUS message, it updates its configuration according to the status of the UNI and the status and service attributes of each configured EVC																														
Test Configuration	Multiple EVCs (enough so that the EVC status Information Elements, service attributes and parameters cannot fit into a single <i>Full Status</i> STATUS message) are simulated by the tester 2 with at least one CE-VLAN ID mapped to each EVC. A per Ingress UNI bandwidth profile is also simulated at the UNI "A". Configure UNI "A" CE Side with the default value of N393. Configure UNI "A" MEN Side with the default values of N393 and T392. Tester 1 with proper PHYs that match the UNI "A" MEN side and CE side is monitoring the E-LMI frames																														
Test Configuration Schematic																															
CE-VLAN ID/EVC Map	<table border="1" style="width: 100%; border-collapse: collapse;"> <thead> <tr> <th colspan="2" style="text-align: center;">UNI 'A'</th> </tr> <tr> <th style="text-align: center;">CE-VLAN ID</th> <th style="text-align: center;">EVC</th> </tr> </thead> <tbody> <tr> <td style="text-align: center;">11*</td> <td style="text-align: center;">EVC₁</td> </tr> <tr> <td style="text-align: center;">12</td> <td style="text-align: center;">EVC₂</td> </tr> </tbody> </table> <p>Use of other EVCs or CE-VLAN IDs is permitted provided that the configuration of the CE-VLAN ID/EVC Map conforms to MEF 10.1</p> <p>The CE-VLAN ID for untagged and priority tagged Service Frames is configured to 11</p>	UNI 'A'		CE-VLAN ID	EVC	11*	EVC ₁	12	EVC ₂																						
UNI 'A'																															
CE-VLAN ID	EVC																														
11*	EVC ₁																														
12	EVC ₂																														
Bandwidth Profile	<table border="1" style="width: 100%; border-collapse: collapse;"> <thead> <tr> <th colspan="5" style="text-align: center;">PER INGRESS UNI</th> </tr> <tr> <th style="text-align: center;">UNI</th> <th colspan="4" style="text-align: center;">Bandwidth Profile Parameters</th> </tr> <tr> <th style="text-align: center;">UNI</th> <th style="text-align: center;">CIR</th> <th style="text-align: center;">CBS</th> <th style="text-align: center;">EIR</th> <th style="text-align: center;">EBS</th> </tr> </thead> <tbody> <tr> <td colspan="5">Note 1: (0 < CIR < Ingress UNI Speed), (CBS ≥ maximum Service Frame size)</td> </tr> <tr> <td colspan="5">Note 2: (Ingress CIR ≤ Egress UNI Speed)</td> </tr> <tr> <td colspan="5">Note 3: (EIR ≥ 0) and (EBS ≥ 0)</td> </tr> </tbody> </table>	PER INGRESS UNI					UNI	Bandwidth Profile Parameters				UNI	CIR	CBS	EIR	EBS	Note 1: (0 < CIR < Ingress UNI Speed), (CBS ≥ maximum Service Frame size)					Note 2: (Ingress CIR ≤ Egress UNI Speed)					Note 3: (EIR ≥ 0) and (EBS ≥ 0)				
PER INGRESS UNI																															
UNI	Bandwidth Profile Parameters																														
UNI	CIR	CBS	EIR	EBS																											
Note 1: (0 < CIR < Ingress UNI Speed), (CBS ≥ maximum Service Frame size)																															
Note 2: (Ingress CIR ≤ Egress UNI Speed)																															
Note 3: (EIR ≥ 0) and (EBS ≥ 0)																															
Test Procedure	Restart the UNI "A" CE Side and use the tester 1 to monitor the E-LMI messages for a period of time ($T = 5 \times T391$). If access to the UNI "A" CE Side local database is possible, verify that upon receipt of a <i>Full Status Continued</i> STATUS messages the UNI "A" CE side (UNI-C) updates its configuration according to the status of the UNI and the status and service attributes of each configured EVC																														
Units	UNI "A" CE side configuration																														
Variables	None																														
Results	Pass or fail																														
Remarks	Test Case must be run using T391 in the range (5-30 seconds) and N391 in the range (1-65k). Suggested values for T391 = 5 and N391 = 2																														

TEST CASE 38C: UNI-C Sending *Full Status Continued* STATUS ENQUIRY

Abstract Test Suite for E-LMI - Procedures																															
Test Name	UNI-C Sending <i>Full Status Continued</i> STATUS ENQUIRY																														
Test Definition ID	UNIC-ELMI-5.6.2-R20																														
Reference Document	MEF 20 UNI Type 2 Implementation Agreement Section 9 MEF 16 Ethernet Local Management Interface																														
Test Type	Conformance																														
Test Status	Mandatory																														
Requirement Description	Upon receipt of a <i>Full Status Continued</i> STATUS message, the UNI-C SHALL continue to request EVC status by sending a <i>Full Status Continued</i> STATUS ENQUIRY message (without waiting for the Polling Timer to expire)																														
Test Object	Verify that upon receipt of a <i>Full Status Continued</i> STATUS message, the UNI-C continues to request EVC status by sending a <i>Full Status Continued</i> STATUS ENQUIRY message (without waiting for the Polling Timer to expire)																														
Test Configuration	Multiple EVCs (enough so that the EVC status Information Elements, service attributes and parameters cannot fit into a single <i>Full Status</i> STATUS message) are simulated by the tester 2 with at least one CE-VLAN ID mapped to each EVC. A per Ingress UNI bandwidth profile is also simulated at the UNI "A". Configure UNI "A" CE Side with the default value of N393. Configure UNI "A" MEN Side with the default values of N393 and T392. Tester 1 with proper PHYs that match the UNI "A" MEN side and CE side is monitoring the E-LMI frames																														
Test Configuration Schematic																															
CE-VLAN ID/EVC Map	<table border="1" style="width: 100%; border-collapse: collapse;"> <thead> <tr> <th colspan="2" style="background-color: #f4a460;">UNI 'A'</th> </tr> <tr> <th style="background-color: #f4a460;">CE-VLAN ID</th> <th style="background-color: #f4a460;">EVC</th> </tr> </thead> <tbody> <tr> <td style="background-color: #ffffcc;">11*</td> <td style="background-color: #ffffcc;">EVC₁</td> </tr> <tr> <td style="background-color: #ffffcc;">12</td> <td style="background-color: #ffffcc;">EVC₂</td> </tr> </tbody> </table> <p>Use of other EVCs or CE-VLAN IDs is permitted provided that the configuration of the CE-VLAN ID/EVC Map conforms to MEF 10.1</p> <p>The CE-VLAN ID for untagged and priority tagged Service Frames is configured to 11</p>	UNI 'A'		CE-VLAN ID	EVC	11*	EVC ₁	12	EVC ₂																						
UNI 'A'																															
CE-VLAN ID	EVC																														
11*	EVC ₁																														
12	EVC ₂																														
Bandwidth Profile	<table border="1" style="width: 100%; border-collapse: collapse;"> <thead> <tr> <th colspan="5" style="background-color: #f4a460;">PER INGRESS UNI</th> </tr> <tr> <th style="background-color: #f4a460;">UNI</th> <th colspan="4" style="background-color: #f4a460;">Bandwidth Profile Parameters</th> </tr> <tr> <th style="background-color: #ffffcc;">UNI</th> <th style="background-color: #ffffcc;">CIR</th> <th style="background-color: #ffffcc;">CBS</th> <th style="background-color: #ffffcc;">EIR</th> <th style="background-color: #ffffcc;">EBS</th> </tr> </thead> <tbody> <tr> <td colspan="5">Note 1: (0 < CIR < Ingress UNI Speed), (CBS ≥ maximum Service Frame size)</td> </tr> <tr> <td colspan="5">Note 2: (Ingress CIR ≤ Egress UNI Speed)</td> </tr> <tr> <td colspan="5">Note 3: (EIR ≥ 0) and (EBS ≥ 0)</td> </tr> </tbody> </table>	PER INGRESS UNI					UNI	Bandwidth Profile Parameters				UNI	CIR	CBS	EIR	EBS	Note 1: (0 < CIR < Ingress UNI Speed), (CBS ≥ maximum Service Frame size)					Note 2: (Ingress CIR ≤ Egress UNI Speed)					Note 3: (EIR ≥ 0) and (EBS ≥ 0)				
PER INGRESS UNI																															
UNI	Bandwidth Profile Parameters																														
UNI	CIR	CBS	EIR	EBS																											
Note 1: (0 < CIR < Ingress UNI Speed), (CBS ≥ maximum Service Frame size)																															
Note 2: (Ingress CIR ≤ Egress UNI Speed)																															
Note 3: (EIR ≥ 0) and (EBS ≥ 0)																															
Test Procedure	Restart the UNI "A" CE Side and use the tester 1 to monitor the E-LMI messages for a period of time ($T = 5 \times T391$). Verify that upon receipt of a <i>Full Status Continued</i> STATUS message the UNI "A" CE side (UNI-C) continues to request EVC status by sending <i>Full Status Continued</i> STATUS ENQUIRY messages (without waiting for the Polling Timer to expire)																														
Units	STATUS ENQUIRY message Report Type and transmission rate in seconds																														
Variables	None																														
Results	Pass or fail																														
Remarks	Test Case must be run using T391 in the range (5-30 seconds) and N391 in the range (1-65k). Suggested values for T391 = 5 and N391 = 2																														

TEST CASE 39C: UNI-C Polling Timer Restart

Abstract Test Suite for E-LMI - Procedures																															
Test Name	UNI-C Polling Timer Restart																														
Test Definition ID	UNIC-ELMI-5.6.2-R20																														
Reference Document	MEF 20 UNI Type 2 Implementation Agreement Section 9 MEF 16 Ethernet Local Management Interface																														
Test Type	Conformance																														
Test Status	Mandatory																														
Requirement Description	The UNI-C SHALL restart Polling Timer with value T391 each time it transmits a <i>Full Status Continued</i> STATUS ENQUIRY message																														
Test Object	Verify that the UNI-C restarts Polling Timer with value T391 each time it transmits a <i>Full Status Continued</i> STATUS ENQUIRY message																														
Test Configuration	Multiple EVCs (enough so that the EVC status Information Elements, service attributes and parameters cannot fit into a single <i>Full Status</i> STATUS message) are simulated by the tester 2 with at least one CE-VLAN ID mapped to each EVC. A per Ingress UNI bandwidth profile is also simulated at the UNI "A". Configure UNI "A" CE Side with the default value of N393. Configure UNI "A" MEN Side with the default values of N393 and T392. Tester 1 with proper PHYs that match the UNI "A" MEN side and CE side is monitoring the E-LMI frames																														
Test Configuration Schematic																															
CE-VLAN ID/EVC Map	<table border="1" style="width: 100%; border-collapse: collapse;"> <thead> <tr> <th colspan="2" style="text-align: center;">UNI 'A'</th> </tr> <tr> <th style="width: 50%;">CE-VLAN ID</th> <th style="width: 50%;">EVC</th> </tr> </thead> <tbody> <tr> <td style="text-align: center;">11*</td> <td style="text-align: center;">EVC₁</td> </tr> <tr> <td style="text-align: center;">12</td> <td style="text-align: center;">EVC₂</td> </tr> <tr> <td colspan="2">Use of other EVCs or CE-VLAN IDs is permitted provided that the configuration of the CE-VLAN ID/EVC Map conforms to MEF 10.1</td> </tr> <tr> <td colspan="2">The CE-VLAN ID for untagged and priority tagged Service Frames is configured to 11</td> </tr> </tbody> </table>	UNI 'A'		CE-VLAN ID	EVC	11*	EVC ₁	12	EVC ₂	Use of other EVCs or CE-VLAN IDs is permitted provided that the configuration of the CE-VLAN ID/EVC Map conforms to MEF 10.1		The CE-VLAN ID for untagged and priority tagged Service Frames is configured to 11																			
UNI 'A'																															
CE-VLAN ID	EVC																														
11*	EVC ₁																														
12	EVC ₂																														
Use of other EVCs or CE-VLAN IDs is permitted provided that the configuration of the CE-VLAN ID/EVC Map conforms to MEF 10.1																															
The CE-VLAN ID for untagged and priority tagged Service Frames is configured to 11																															
Bandwidth Profile	<table border="1" style="width: 100%; border-collapse: collapse;"> <thead> <tr> <th colspan="5" style="text-align: center;">PER INGRESS UNI</th> </tr> <tr> <th style="width: 50%;">UNI</th> <th colspan="4" style="text-align: center;">Bandwidth Profile Parameters</th> </tr> <tr> <th style="text-align: center;">UNI</th> <th style="text-align: center;">CIR</th> <th style="text-align: center;">CBS</th> <th style="text-align: center;">EIR</th> <th style="text-align: center;">EBS</th> </tr> </thead> <tbody> <tr> <td colspan="5">Note 1: (0 < CIR < Ingress UNI Speed), (CBS ≥ maximum Service Frame size)</td> </tr> <tr> <td colspan="5">Note 2: (Ingress CIR ≤ Egress UNI Speed)</td> </tr> <tr> <td colspan="5">Note 3: (EIR ≥ 0) and (EBS ≥ 0)</td> </tr> </tbody> </table>	PER INGRESS UNI					UNI	Bandwidth Profile Parameters				UNI	CIR	CBS	EIR	EBS	Note 1: (0 < CIR < Ingress UNI Speed), (CBS ≥ maximum Service Frame size)					Note 2: (Ingress CIR ≤ Egress UNI Speed)					Note 3: (EIR ≥ 0) and (EBS ≥ 0)				
PER INGRESS UNI																															
UNI	Bandwidth Profile Parameters																														
UNI	CIR	CBS	EIR	EBS																											
Note 1: (0 < CIR < Ingress UNI Speed), (CBS ≥ maximum Service Frame size)																															
Note 2: (Ingress CIR ≤ Egress UNI Speed)																															
Note 3: (EIR ≥ 0) and (EBS ≥ 0)																															
Test Procedure	Restart the UNI "A" CE Side and use the tester 1 to monitor the E-LMI messages for a period of time ($T = 5 \times T391$). Use tester 2 to respond to the first <i>Full Status</i> STATUS ENQUIRY message sent by the UNI-C by sending a <i>Full Status Continued</i> STATUS message. Use tester 2 to verify that the time interval between the receipt of the first <i>Full Status</i> STATUS ENQUIRY and the first <i>Full Status Continued</i> STATUS ENQUIRY messages sent by the UNI "A" CE side (UNI-C) is less than T391 (restarted before timeout). Prevent tester 2 from responding to the first <i>Full Status Continued</i> STATUS ENQUIRY and verify that the time interval between the receipt of the first <i>Full Status Continued</i> STATUS ENQUIRY and the next <i>Full Status</i> STATUS ENQUIRY messages sent by the UNI "A" CE side (UNI-C) is within + / - 5% of the value of T391 as measured by the tester (T391 timedout)																														
Units	Seconds																														
Variables	None																														
Results	Pass or fail																														
Remarks	Test Case must be run using T391 in the range (5-30 seconds) and N391 in the range (1-65k). Suggested values for T391 = 5 and N391 = 2																														

TEST CASE 40C: UNI-C EVC Reference ID Comparison

Abstract Test Suite for E-LMI - Procedures													
Test Name	UNI-C EVC Reference ID Comparison												
Test Definition ID	UNIC-ELMI-5.6.2-R20												
Reference Document	MEF 20 UNI Type 2 Implementation Agreement Section 9 MEF 16 Ethernet Local Management Interface												
Test Type	Conformance												
Test Status	Mandatory if access to the UNI-C list of configured EVCs is possible												
Requirement Description	The UNI-C SHALL compare the EVC reference ID sent in the full status with the previously reported EVC reference ID and omission of any EVC reference ID will result in deletion of that EVC												
Test Object	Verify that the UNI-C compares the EVC reference ID sent in the full status with the previously reported EVC reference ID and omission of any EVC reference ID results in deletion of that EVC												
Test Configuration	At least two EVCs are simulated by the tester 2 and at least one CE-VLAN ID is mapped to each EVC. A per Ingress UNI bandwidth profile is also simulated at the UNI "A". Configure UNI "A" CE Side with the default value of N393. Configure UNI "A" MEN Side with the default values of N393 and T392. Tester 1 with proper PHYs that match the UNI "A" MEN side and CE side is monitoring the E-LMI frames												
Test Configuration Schematic													
CE-VLAN ID/EVC Map	<table border="1" style="width: 100%; border-collapse: collapse;"> <thead> <tr> <th colspan="2" style="background-color: #f4a460;">UNI 'A'</th> </tr> <tr> <th style="background-color: #f4a460;">CE-VLAN ID</th> <th style="background-color: #f4a460;">EVC</th> </tr> </thead> <tbody> <tr> <td style="background-color: #ffffcc;">11*</td> <td style="background-color: #ffffcc;">EVC₁</td> </tr> <tr> <td style="background-color: #ffffcc;">12</td> <td style="background-color: #ffffcc;">EVC₂</td> </tr> <tr> <td colspan="2">Use of other EVCs or CE-VLAN IDs is permitted provided that the configuration of the CE-VLAN ID/EVC Map conforms to MEF 10.1</td> </tr> <tr> <td colspan="2">The CE-VLAN ID for untagged and priority tagged Service Frames is configured to 11</td> </tr> </tbody> </table>	UNI 'A'		CE-VLAN ID	EVC	11*	EVC ₁	12	EVC ₂	Use of other EVCs or CE-VLAN IDs is permitted provided that the configuration of the CE-VLAN ID/EVC Map conforms to MEF 10.1		The CE-VLAN ID for untagged and priority tagged Service Frames is configured to 11	
UNI 'A'													
CE-VLAN ID	EVC												
11*	EVC ₁												
12	EVC ₂												
Use of other EVCs or CE-VLAN IDs is permitted provided that the configuration of the CE-VLAN ID/EVC Map conforms to MEF 10.1													
The CE-VLAN ID for untagged and priority tagged Service Frames is configured to 11													
Bandwidth Profile	<table border="1" style="width: 100%; border-collapse: collapse;"> <thead> <tr> <th colspan="2" style="background-color: #f4a460;">PER INGRESS UNI</th> </tr> <tr> <th style="background-color: #f4a460;">UNI</th> <th style="background-color: #f4a460;">Bandwidth Profile Parameters</th> </tr> <tr> <th style="background-color: #ffffcc;">UNI</th> <th style="background-color: #ffffcc;">CIR CBS EIR EBS</th> </tr> </thead> <tbody> <tr> <td colspan="2">Note 1: (0 < CIR < Ingress UNI Speed), (CBS ≥ maximum Service Frame size)</td> </tr> <tr> <td colspan="2">Note 2: (Ingress CIR ≤ Egress UNI Speed)</td> </tr> <tr> <td colspan="2">Note 3: (EIR ≥ 0) and (EBS ≥ 0)</td> </tr> </tbody> </table>	PER INGRESS UNI		UNI	Bandwidth Profile Parameters	UNI	CIR CBS EIR EBS	Note 1: (0 < CIR < Ingress UNI Speed), (CBS ≥ maximum Service Frame size)		Note 2: (Ingress CIR ≤ Egress UNI Speed)		Note 3: (EIR ≥ 0) and (EBS ≥ 0)	
PER INGRESS UNI													
UNI	Bandwidth Profile Parameters												
UNI	CIR CBS EIR EBS												
Note 1: (0 < CIR < Ingress UNI Speed), (CBS ≥ maximum Service Frame size)													
Note 2: (Ingress CIR ≤ Egress UNI Speed)													
Note 3: (EIR ≥ 0) and (EBS ≥ 0)													
Test Procedure	Restart the UNI "A" CE Side and use the tester 1 to monitor the E-LMI messages for a period of time ($T = 5 \times N391 \times T391$). During the second Full Status procedure, use the tester 2 to no longer include status of EVC ₁ meaning that the EVC ₁ reference ID is not contained in <i>Full Status</i> STATUS messages. If access to the UNI "A" CE Side data base is possible, verify that upon the receipt of a <i>full Status</i> STATUS message, the UNI "A" CE Side (UNI-C) compares the EVC reference IDs with the previously reported EVC reference IDs and omission of EVC ₁ reference ID results in deletion of that EVC from the CE Side data base (list of configured EVCs).												
Units	UNI "A" CE Side list of configured EVCs												
Variables	None												
Results	Pass or fail												
Remarks	Test Case must be run using T391 in the range (5-30 seconds) and N391 in the range (1-65k). Suggested values for T391 = 5 and N391 = 2												

TEST CASE 41C: Sequence Counter Increment - Send Sequence Number Field

Abstract Test Suite for E-LMI - Procedures	
Test Name	Sequence Counter Increment - Send Sequence Number Field
Test Definition ID	UNIC-ELMI-5.6.3-R20
Reference Document	MEF 20 UNI Type 2 Implementation Agreement Section 9 MEF 16 Ethernet Local Management Interface
Test Type	Conformance
Test Status	Mandatory
Requirement Description	Each time the UNI-C sends a STATUS ENQUIRY message, it SHALL increment the send sequence counter and place its value into the send sequence number field
Test Object	Verify that each time the UNI-C sends a STATUS ENQUIRY message, it increments the send sequence counter and places its value into the send sequence number field
Test Configuration	Configure UNI "A" CE Side with the default value of N393. Configure UNI "A" MEN Side with the default values of N393 and T392. Tester 1 with proper PHYs that match the UNI "A" MEN side and CE side is monitoring the E-LMI frames
Test Configuration Schematic	<pre> graph LR T2[UNI 'A' MEN Side Tester 2 (Impairment Generator)] --- T1[Monitor Mode Tester 1] T1 --- UC[UNI 'A' CE Side UNI-C Under Test] </pre>
CE-VLAN ID/EVC Map	Not Specified
Bandwidth Profile	Not Specified
Test Procedure	Restart the UNI "A" CE Side and use the tester 1 to monitor the E-LMI messages for a period of time ($T = 5 \times T391$). Verify that the send sequence number field of the STATUS ENQUIRY messages transmitted by the UNI "A" CE Side (UNI-C) increments with each transmitted message
Units	STATUS ENQUIRY message send sequence number field value
Variables	None
Results	Pass or fail
Remarks	Test Case must be run using T391 in the range (5-30 seconds) and N391 in the range (1-65k). Suggested values for T391 = 5 and N391 = 2

TEST CASE 42C: Sequence Counter Increment - Receive Sequence Number Field

Abstract Test Suite for E-LMI - Procedures	
Test Name	Sequence Counter Increment - Receive Sequence Number Field
Test Definition ID	UNIC-ELMI-5.6.3-R20
Reference Document	MEF 20 UNI Type 2 Implementation Agreement Section 9 MEF 16 Ethernet Local Management Interface
Test Type	Conformance
Test Status	Mandatory
Requirement Description	Each time the UNI-C sends a STATUS ENQUIRY message, it SHALL place the current value of the receive sequence counter into the receive sequence number field of the Sequence Numbers Information Element
Test Object	Verify that each time the UNI-C sends a STATUS ENQUIRY message, it places the current value of the receive sequence counter into the receive sequence number field of the Sequence Numbers Information Element
Test Configuration	Configure UNI "A" CE Side with the default value of N393. Configure UNI "A" MEN Side with the default values of N393 and T392. Tester 1 with proper PHYs that match the UNI "A" MEN side and CE side is monitoring the E-LMI frames
Test Configuration Schematic	<pre> graph LR T2[UNI 'A' MEN Side Tester 2 (Impairment Generator)] --- T1[Monitor Mode Tester 1] T1 --- UC[UNI 'A' CE Side UNI-C Under Test] </pre>
CE-VLAN ID/EVC Map	Not Specified
Bandwidth Profile	Not Specified
Test Procedure	Restart the UNI "A" CE Side and use the tester 1 to monitor the E-LMI messages for a period of time ($T = 5 \times T391$). Verify that the receive sequence number of each STATUS ENQUIRY message transmitted by the UNI "A" CE side (UNI-C) is equal to the send sequence number of the last STATUS message received from the tester 2.
Units	STATUS ENQUIRY message receive sequence number field value
Variables	None
Results	Pass or fail
Remarks	Test Case must be run using T391 in the range (5-30 seconds) and N391 in the range (1-65k). Suggested values for T391 = 5 and N391 = 2

TEST CASE 43C: Send Sequence Counter - Zero Value Skipped

Abstract Test Suite for E-LMI - Procedures	
Test Name	Send Sequence Counter - Zero Value Skipped
Test Definition ID	UNIC-ELMI-5.6.3-R20
Reference Document	MEF 20 UNI Type 2 Implementation Agreement Section 9 MEF 16 Ethernet Local Management Interface
Test Type	Conformance
Test Status	Mandatory
Requirement Description	The UNI-C increments the send sequence counter using modulo 256. The value zero SHALL be skipped
Test Object	Verify that the UNI-C increments the send sequence counter using modulo 256 and that the value zero is skipped
Test Configuration	Configure UNI "A" CE Side with the default value of N393. Configure UNI "A" MEN Side with the default values of N393 and T392. Tester 1 with proper PHYs that match the UNI "A" MEN side and CE side is monitoring the E-LMI frames
Test Configuration Schematic	<pre> graph LR T2[UNI 'A' MEN Side Tester 2 (Impairment Generator)] --- T1[Monitor Mode Tester 1] T1 --- UC[UNI 'A' CE Side UNI-C Under Test] </pre>
CE-VLAN ID/EVC Map	Not Specified
Bandwidth Profile	Not Specified
Test Procedure	Restart the UNI "A" CE Side and use the tester 1 to monitor the E-LMI messages. Monitor at least 256 consecutive STATUS ENQUIRY messages transmitted by the UNI "A" CE side (UNI-C) and verify that the send sequence number field increments using modulo 256 and that the value zero is skipped
Units	STATUS ENQUIRY message send sequence number field value
Variables	None
Results	Pass or fail
Remarks	Test Case must be run using T391 in the range (5-30 seconds) and N391 in the range (1-65k). Suggested values for T391 = 5 and N391 = 2

TEST CASE 48C: UNI-C Initialization - Data Instance

Abstract Test Suite for E-LMI - Procedures	
Test Name	UNI-C Initialization - Data Instance
Test Definition ID	UNIC-ELMI-5.6.7.1-R20
Reference Document	MEF 20 UNI Type 2 Implementation Agreement Section 9 MEF 16 Ethernet Local Management Interface
Test Type	Conformance
Test Status	Mandatory
Requirement Description	When the UNI-C comes up for first time or is restarted, the UNI-C MUST set its DI to 0
Test Object	Verify that when the UNI-C comes up for first time or is restarted, the UNI-C sets its DI to 0
Test Configuration	Configure UNI "A" CE Side with the default value of N393. Configure UNI "A" MEN Side with the default values of N393 and T392. Tester 1 with proper PHYs that match the UNI "A" MEN side and CE side is monitoring the E-LMI frames
Test Configuration Schematic	
CE-VLAN ID/EVC Map	Not Specified
Bandwidth Profile	Not Specified
Test Procedure	Restart the UNI "A" CE Side and use the tester 1 to monitor the E-LMI messages for a period of time ($T = 2 \times T391$). Verify that the Data Instance of the first STATUS ENQUIRY message sent by the UNI "A" CE Side (UNI-C) is set to 0
Units	Data Instance value
Variables	None
Results	Pass or fail
Remarks	Test Case must be run using T391 in the range (5-30 seconds) and N391 in the range (1-65k). Suggested values for T391 = 5 and N391 = 2

TEST CASE 49C: UNI-C Initialization - Report Type

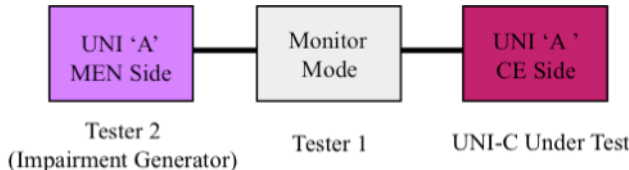
Abstract Test Suite for E-LMI - Procedures	
Test Name	UNI-C Initialization - Report Type
Test Definition ID	UNIC-ELMI-5.6.7.1-R20
Reference Document	MEF 20 UNI Type 2 Implementation Agreement Section 9 MEF 16 Ethernet Local Management Interface
Test Type	Conformance
Test Status	Mandatory
Requirement Description	When the UNI-C comes up for first time or is restarted, the UNI-C MUST send the ELM I STATUS ENQUIRY with Report Type <i>Full Status</i>
Test Object	Verify that when the UNI-C comes up for first time or is restarted, the UNI-C sends the ELM I STATUS ENQUIRY with Report Type <i>Full Status</i>
Test Configuration	Configure UNI "A" CE Side with the default value of N393. Configure UNI "A" MEN Side with the default values of N393 and T392. Tester 1 with proper PHYs that match the UNI "A" MEN side and CE side is monitoring the E-LMI frames
Test Configuration Schematic	 <pre> graph LR T2[Tester 2 (Impairment Generator)] --- U1[UNI 'A' MEN Side] U1 --- M[Monitor Mode] M --- U2[UNI 'A' CE Side] subgraph Labels T2 --- L1[Tester 2 (Impairment Generator)] M --- L2[Tester 1] U2 --- L3[UNI-C Under Test] end </pre>
CE-VLAN ID/EVC Map	Not Specified
Bandwidth Profile	Not Specified
Test Procedure	Restart the UNI "A" CE Side and use the tester 1 to monitor the E-LMI messages for a period of time ($T = 2 \times T391$). Verify that the Report Type of the first STATUS ENQUIRY message sent by the UNI "A" CE Side (UNI-C) is <i>Full Status</i>
Units	Report Type value
Variables	None
Results	Pass or fail
Remarks	Test Case must be run using T391 in the range (5-30 seconds) and N391 in the range (1-65k). Suggested values for T391 = 5 and N391 = 2

TEST CASE 50C: UNI-C Receiving *Full Status* or *Full Status Continued* Reports

Abstract Test Suite for E-LMI - Procedures																															
Test Name	UNI-C Receiving <i>Full Status</i> or <i>Full Status Continued</i> Reports																														
Test Definition ID	UNIC-ELMI-5.6.7.1-R20																														
Reference Document	MEF 20 UNI Type 2 Implementation Agreement Section 9 MEF 16 Ethernet Local Management Interface																														
Test Type	Conformance																														
Test Status	Mandatory																														
Requirement Description	At the stage when the UNI-C receives <i>Full Status</i> or <i>Full Status Continued</i> reports, including the latest UNI and EVC information and update its local database, the UNI-C's local DI MUST be set to the UNI-N DI that is received in the <i>Full Status</i> report																														
Test Object	Verify that at the stage when the UNI-C receives <i>Full Status</i> or <i>Full Status Continued</i> reports, including the latest UNI and EVC information and update its local database, the UNI-C's local DI is set to the UNI-N DI that is received in the <i>Full Status</i> report																														
Test Configuration	Multiple EVCs (enough so that the EVC status Information Elements, service attributes and parameters cannot fit into a single <i>Full Status</i> STATUS message) are simulated by the tester 2 and at least one CE-VLAN ID is mapped to each EVC. A per Ingress UNI bandwidth profile is also simulated at the UNI "A". Configure UNI "A" CE Side with the default value of N393. Configure UNI "A" MEN Side with the default values of N393 and T392. Tester 1 with proper PHYs that match the UNI "A" MEN side and CE side is monitoring the E-LMI frames																														
Test Configuration Schematic	<pre> graph LR T2[Tester 2 (Impairment Generator)] --- UAMEN[UNI 'A' MEN Side] UAMEN --- MM[Monitor Mode] MM --- UACE[UNI 'A' CE Side] subgraph UCI [UNI-C Under Test] UACE end </pre>																														
CE-VLAN ID/EVC Map	<table border="1" style="width: 100%; border-collapse: collapse;"> <thead> <tr> <th colspan="2" style="text-align: center;">UNI 'A'</th> </tr> <tr> <th style="width: 50%;">CE-VLAN ID</th> <th style="width: 50%;">EVC</th> </tr> </thead> <tbody> <tr> <td style="text-align: center;">11*</td> <td style="text-align: center;">EVC₁</td> </tr> <tr> <td style="text-align: center;">12</td> <td style="text-align: center;">EVC₂</td> </tr> </tbody> </table> <p>Use of other EVCs or CE-VLAN IDs is permitted provided that the configuration of the CE-VLAN ID/EVC Map conforms to MEF 10.1</p> <p>The CE-VLAN ID for untagged and priority tagged Service Frames is configured to 11</p>	UNI 'A'		CE-VLAN ID	EVC	11*	EVC ₁	12	EVC ₂																						
UNI 'A'																															
CE-VLAN ID	EVC																														
11*	EVC ₁																														
12	EVC ₂																														
Bandwidth Profile	<table border="1" style="width: 100%; border-collapse: collapse;"> <thead> <tr> <th colspan="5" style="text-align: center;">PER INGRESS UNI</th> </tr> <tr> <th style="width: 50%;">UNI</th> <th colspan="4" style="text-align: center;">Bandwidth Profile Parameters</th> </tr> <tr> <th style="text-align: center;">UNI</th> <th style="text-align: center;">CIR</th> <th style="text-align: center;">CBS</th> <th style="text-align: center;">EIR</th> <th style="text-align: center;">EBS</th> </tr> </thead> <tbody> <tr> <td colspan="5">Note 1: (0 < CIR < Ingress UNI Speed), (CBS ≥ maximum Service Frame size)</td> </tr> <tr> <td colspan="5">Note 2: (Ingress CIR ≤ Egress UNI Speed)</td> </tr> <tr> <td colspan="5">Note 3: (EIR ≥ 0) and (EBS ≥ 0)</td> </tr> </tbody> </table>	PER INGRESS UNI					UNI	Bandwidth Profile Parameters				UNI	CIR	CBS	EIR	EBS	Note 1: (0 < CIR < Ingress UNI Speed), (CBS ≥ maximum Service Frame size)					Note 2: (Ingress CIR ≤ Egress UNI Speed)					Note 3: (EIR ≥ 0) and (EBS ≥ 0)				
PER INGRESS UNI																															
UNI	Bandwidth Profile Parameters																														
UNI	CIR	CBS	EIR	EBS																											
Note 1: (0 < CIR < Ingress UNI Speed), (CBS ≥ maximum Service Frame size)																															
Note 2: (Ingress CIR ≤ Egress UNI Speed)																															
Note 3: (EIR ≥ 0) and (EBS ≥ 0)																															
Test Procedure	Restart the UNI "A" CE Side and use the tester 1 to monitor the E-LMI messages for a period of time ($T = 5 \times T391$). At the stage when the UNI "A" CE Side (UNI-C) receives <i>Full Status</i> or <i>Full Status Continued</i> reports, verify that the local DI in the STATUS ENQUIRY messages sent by the UNI-C is set to the UNI-N DI value received in the <i>Full Status</i> report and that it does not change until the status procedure is complete																														
Units	STATUS ENQUIRY messages Data Instance value																														
Variables	None																														
Results	Pass or fail																														
Remarks	Test Case must be run using T391 in the range (5-30 seconds) and N391 in the range (1-65k). Suggested values for T391 = 5 and N391 = 2																														

TEST CASE 51C: Polling Timer (PT) Expiry

Abstract Test Suite for E-LMI - Procedures	
Test Name	Polling Timer (PT) Expiry
Test Definition ID	UNIC-ELMI-5.6.7.1-R20
Reference Document	MEF 20 UNI Type 2 Implementation Agreement Section 9 MEF 16 Ethernet Local Management Interface
Test Type	Conformance
Test Status	Mandatory
Requirement Description	On PT expiry with the Polling Counter not equal to 0, the UNI-C SHALL decrement the Polling Counter and send <i>E-LMI Check</i> with local DI included
Test Object	Verify that on PT expiry with the Polling Counter not equal to 0, the UNI-C decrements the Polling Counter and send <i>E-LMI Check</i> with local DI included
Test Configuration	Configure UNI "A" CE Side with the default value of N393. Configure UNI "A" MEN Side with the default values of N393 and T392. Tester 1 with proper PHYs that match the UNI "A" MEN side and CE side is monitoring the E-LMI frames
Test Configuration Schematic	<pre> graph LR T2[Tester 2 (Impairment Generator)] --- U1[UNI 'A' MEN Side] U1 --- M[Monitor Mode] M --- U2[UNI 'A' CE Side] subgraph Labels L1[Tester 2 (Impairment Generator)] L2[Tester 1] L3[UNI-C Under Test] end style U1 fill:#9933cc,color:#fff style M fill:#cccccc style U2 fill:#990066,color:#fff </pre>
CE-VLAN ID/EVC Map	Not Specified
Bandwidth Profile	Not Specified
Test Procedure	Restart the UNI "A" CE Side and use the tester 1 to monitor the E-LMI messages for a period of <i>time</i> ($T = 5 \times N391 \times T391$). Use the tester 2 to keep the DI of all the STATUS messages constant and count the number of <i>E-LMI Check</i> messages with local DI included sent between two <i>Full Status</i> STATUS ENQUIRY messages and verify that the count of <i>E-LMI check</i> messages is equal to N391.
Units	Report Type & Data Instance values
Variables	N391
Results	Pass or fail
Remarks	Test Case must be run using T391 in the range (5-30 seconds) and N391 in the range (1-65k). Suggested values for T391 = 5 and N391 = 2 and 5.

TEST CASE 52C: Receipt of STATUS Message with DI Mismatch

Abstract Test Suite for E-LMI - Procedures	
Test Name	Receipt of STATUS Message with DI Mismatch
Test Definition ID	UNIC-ELMI-5.6.7.1-R20
Reference Document	MEF 20 UNI Type 2 Implementation Agreement Section 9 MEF 16 Ethernet Local Management Interface
Test Type	Conformance
Test Status	Mandatory
Requirement Description	On receipt of the STATUS message, the UNI-C SHALL compare the received UNI-N DI with its local DI and if there is a mismatch the UNI-C MUST immediately send a FULL STATUS message with its local DI value
Test Object	Verify that on receipt of the STATUS message, the UNI-C compares the received UNI-N DI with its local DI and if there is a mismatch the UNI-C immediately sends a FULL STATUS message with its local DI value
Test Configuration	Configure UNI "A" CE Side with the default value of N393. Configure UNI "A" MEN Side with the default values of N393 and T392. Tester 1 with proper PHYs that match the UNI "A" MEN side and CE side is monitoring the E-LMI frames
Test Configuration Schematic	<pre> graph LR T2[UNI 'A' MEN Side Tester 2 (Impairment Generator)] --- T1[Monitor Mode Tester 1] T1 --- UCT[UNI 'A' CE Side UNI-C Under Test] </pre>
CE-VLAN ID/EVC Map	Not Specified
Bandwidth Profile	Not Specified
Test Procedure	Restart the UNI "A" CE Side and use the tester 1 to monitor the E-LMI messages for a period of time ($T = 5 \times T391$). After the first Full Status procedure is complete, use the tester 2 to increment the DI value in a STATUS message and verify that upon the receipt of that STATUS message, the UNI "A" CE Side (UNI-C) immediately sends a <i>Full Status</i> STATUS ENQUIRY message with its local DI value
Units	Report Type & Data Instance value
Variables	None
Results	Pass or fail
Remarks	Test Case must be run using T391 in the range (5-30 seconds) and N391 in the range (1-65k). Suggested values for T391 = 5 and N391 = 2

TEST CASE 61C: Full Status STATUS Message Receipt - Add EVC

Abstract Test Suite for E-LMI - Procedures																															
Test Name	Full Status STATUS Message Receipt - Add EVC																														
Test Definition ID	UNIC-ELMI-5.6.8-R20																														
Reference Document	MEF 20 UNI Type 2 Implementation Agreement Section 9 MEF 16 Ethernet Local Management Interface																														
Test Type	Conformance																														
Test Status	Mandatory if access to the UNI-C list of configured EVCs is possible																														
Requirement Description	When the UNI-C receives a <i>Full Status</i> STATUS message containing an EVC Information Element with the “New” bit of the EVC Status Information Element set to 1, the UNI-C SHALL add this new EVC to its list of configured EVCs																														
Test Object	Verify that when the UNI-C receives a <i>Full Status</i> STATUS message containing an EVC Information Element with the “New” bit of the EVC Status Information Element set to 1, the UNI-C adds this new EVC to its list of configured EVCs																														
Test Configuration	At least one EVC is simulated by the tester 2 and at least one CE-VLAN ID is mapped to each EVC. A per Ingress UNI bandwidth profile is also simulated at the UNI “A”. Configure UNI “A” CE Side with the default value of N393. Configure UNI “A” MEN Side with the default values of N393 and T392. Tester 1 with proper PHYs that match the UNI “A” MEN side and CE side is monitoring the E-LMI frames																														
Test Configuration Schematic																															
CE-VLAN ID/EVC Map	<table border="1" style="width: 100%; border-collapse: collapse;"> <thead> <tr> <th colspan="2" style="text-align: center;">UNI ‘A’</th> </tr> <tr> <th style="text-align: center;">CE-VLAN ID</th> <th style="text-align: center;">EVC</th> </tr> </thead> <tbody> <tr> <td style="text-align: center;">11*</td> <td style="text-align: center;">EVC₁</td> </tr> <tr> <td colspan="2">Use of other EVCs or CE-VLAN IDs is permitted provided that the configuration of the CE-VLAN ID/EVC Map conforms to MEF 10.1</td> </tr> <tr> <td colspan="2">The CE-VLAN ID for untagged and priority tagged Service Frames is configured to 11</td> </tr> </tbody> </table>	UNI ‘A’		CE-VLAN ID	EVC	11*	EVC ₁	Use of other EVCs or CE-VLAN IDs is permitted provided that the configuration of the CE-VLAN ID/EVC Map conforms to MEF 10.1		The CE-VLAN ID for untagged and priority tagged Service Frames is configured to 11																					
UNI ‘A’																															
CE-VLAN ID	EVC																														
11*	EVC ₁																														
Use of other EVCs or CE-VLAN IDs is permitted provided that the configuration of the CE-VLAN ID/EVC Map conforms to MEF 10.1																															
The CE-VLAN ID for untagged and priority tagged Service Frames is configured to 11																															
Bandwidth Profile	<table border="1" style="width: 100%; border-collapse: collapse;"> <thead> <tr> <th colspan="5" style="text-align: center;">PER INGRESS UNI</th> </tr> <tr> <th style="text-align: center;">UNI</th> <th colspan="4" style="text-align: center;">Bandwidth Profile Parameters</th> </tr> <tr> <th style="text-align: center;">UNI</th> <th style="text-align: center;">CIR</th> <th style="text-align: center;">CBS</th> <th style="text-align: center;">EIR</th> <th style="text-align: center;">EBS</th> </tr> </thead> <tbody> <tr> <td colspan="5">Note 1: (0 < CIR < Ingress UNI Speed), (CBS ≥ maximum Service Frame size)</td> </tr> <tr> <td colspan="5">Note 2: (Ingress CIR ≤ Egress UNI Speed)</td> </tr> <tr> <td colspan="5">Note 3: (EIR ≥ 0) and (EBS ≥ 0)</td> </tr> </tbody> </table>	PER INGRESS UNI					UNI	Bandwidth Profile Parameters				UNI	CIR	CBS	EIR	EBS	Note 1: (0 < CIR < Ingress UNI Speed), (CBS ≥ maximum Service Frame size)					Note 2: (Ingress CIR ≤ Egress UNI Speed)					Note 3: (EIR ≥ 0) and (EBS ≥ 0)				
PER INGRESS UNI																															
UNI	Bandwidth Profile Parameters																														
UNI	CIR	CBS	EIR	EBS																											
Note 1: (0 < CIR < Ingress UNI Speed), (CBS ≥ maximum Service Frame size)																															
Note 2: (Ingress CIR ≤ Egress UNI Speed)																															
Note 3: (EIR ≥ 0) and (EBS ≥ 0)																															
Test Procedure	Restart the UNI “A” CE Side and use the tester 1 to monitor the E-LMI messages for a period of time ($T = 5 \times N391 \times T391$). During the second Full Status procedure, use the tester 2 to simulate the addition of a new EVC by sending a <i>Full Status</i> STATUS message containing an EVC Information Element with the “New” bit of the EVC Status Information Element set to 1 and if access to the UNI “A” CE Side data base is possible, verify that upon the receipt of a <i>Full Status</i> STATUS message containing an EVC Information Element with the “New” bit of the EVC Status Information Element set to 1, the UNI-C adds this new EVC to its list of configured EVCs																														
Units	UNI “A” CE Side list of configured EVCs																														
Variables	None																														
Results	Pass or fail																														
Remarks	Test Case must be run using T391 in the range (5-30 seconds) and N391 in the range (1-65k). Suggested values for T391 = 5 and N391 = 2																														

TEST CASE 62C: Full Status Continued STATUS Message Receipt - Add EVC

Abstract Test Suite for E-LMI - Procedures																															
Test Name	Full Status Continued STATUS Message Receipt - Add EVC																														
Test Definition ID	UNIC-ELMI-5.6.8-R20																														
Reference Document	MEF 20 UNI Type 2 Implementation Agreement Section 9 MEF 16 Ethernet Local Management Interface																														
Test Type	Conformance																														
Test Status	Mandatory if access to the UNI-C list of configured EVCs is possible																														
Requirement Description	When the UNI-C receives a <i>Full Status Continued</i> STATUS message containing an EVC Information Element with the “New” bit of the EVC Status Information Element set to 1, the UNI-C SHALL add this new EVC to its list of configured EVCs																														
Test Object	Verify that when the UNI-C receives a <i>Full Status Continued</i> STATUS message containing an EVC Information Element with the “New” bit of the EVC Status Information Element set to 1, the UNI-C adds this new EVC to its list of configured EVCs																														
Test Configuration	Multiple EVCs (enough so that the EVC status Information Elements, service attributes and parameters cannot fit into a single <i>Full Status</i> STATUS message) are simulated by the tester 2 and at least one CE-VLAN ID is mapped to each EVC. A per Ingress UNI bandwidth profile is also simulated at the UNI “A”. Configure UNI “A” CE Side with the default value of N393. Configure UNI “A” MEN Side with the default values of N393 and T392. Tester 1 with proper PHYs that match the UNI “A” MEN side and CE side is monitoring the E-LMI frames																														
Test Configuration Schematic	<pre> graph LR T2[Tester 2 (Impairment Generator)] --- UAMEN[UNI 'A' MEN Side] UAMEN --- MM[Monitor Mode] MM --- UACE[UNI 'A' CE Side] subgraph Labels T2 --- T2L[Tester 2 (Impairment Generator)] MM --- T1[Tester 1] UACE --- UACEL[UNI-C Under Test] end </pre>																														
CE-VLAN ID/EVC Map	<table border="1" style="width: 100%; border-collapse: collapse;"> <thead> <tr> <th colspan="2" style="text-align: center;">UNI ‘A’</th> </tr> <tr> <th style="width: 50%;">CE-VLAN ID</th> <th style="width: 50%;">EVC</th> </tr> </thead> <tbody> <tr> <td style="text-align: center;">11*</td> <td style="text-align: center;">EVC₁</td> </tr> <tr> <td style="text-align: center;">12</td> <td style="text-align: center;">EVC₂</td> </tr> </tbody> </table> <p>Use of other EVCs or CE-VLAN IDs is permitted provided that the configuration of the CE-VLAN ID/EVC Map conforms to MEF 10.1</p> <p>The CE-VLAN ID for untagged and priority tagged Service Frames is configured to 11</p>	UNI ‘A’		CE-VLAN ID	EVC	11*	EVC ₁	12	EVC ₂																						
UNI ‘A’																															
CE-VLAN ID	EVC																														
11*	EVC ₁																														
12	EVC ₂																														
Bandwidth Profile	<table border="1" style="width: 100%; border-collapse: collapse;"> <thead> <tr> <th colspan="5" style="text-align: center;">PER INGRESS UNI</th> </tr> <tr> <th style="width: 50%;">UNI</th> <th colspan="4" style="text-align: center;">Bandwidth Profile Parameters</th> </tr> <tr> <th style="text-align: center;">UNI</th> <th style="text-align: center;">CIR</th> <th style="text-align: center;">CBS</th> <th style="text-align: center;">EIR</th> <th style="text-align: center;">EBS</th> </tr> </thead> <tbody> <tr> <td colspan="5">Note 1: (0 < CIR < Ingress UNI Speed), (CBS ≥ maximum Service Frame size)</td> </tr> <tr> <td colspan="5">Note 2: (Ingress CIR ≤ Egress UNI Speed)</td> </tr> <tr> <td colspan="5">Note 3: (EIR ≥ 0) and (EBS ≥ 0)</td> </tr> </tbody> </table>	PER INGRESS UNI					UNI	Bandwidth Profile Parameters				UNI	CIR	CBS	EIR	EBS	Note 1: (0 < CIR < Ingress UNI Speed), (CBS ≥ maximum Service Frame size)					Note 2: (Ingress CIR ≤ Egress UNI Speed)					Note 3: (EIR ≥ 0) and (EBS ≥ 0)				
PER INGRESS UNI																															
UNI	Bandwidth Profile Parameters																														
UNI	CIR	CBS	EIR	EBS																											
Note 1: (0 < CIR < Ingress UNI Speed), (CBS ≥ maximum Service Frame size)																															
Note 2: (Ingress CIR ≤ Egress UNI Speed)																															
Note 3: (EIR ≥ 0) and (EBS ≥ 0)																															
Test Procedure	Restart the UNI “A” CE Side and use the tester 1 to monitor the E-LMI messages for a period of time ($T = 5 \times N391 \times T391$). During the second Full Status procedure, use the tester 2 to simulate the addition a new EVC by sending a <i>Full Status Continued</i> STATUS message containing an EVC Information Element with the “New” bit of the EVC Status Information Element set to 1 and if access to the UNI “A” CE Side data base is possible, verify that upon the receipt of a <i>Full Status Continued</i> STATUS message containing an EVC Information Element with the “New” bit of the EVC Status Information Element set to 1, the UNI-C adds this new EVC to its list of configured EVCs																														
Units	UNI “A” CE Side list of configured EVCs																														
Variables	None																														
Results	Pass or fail																														
Remarks	Test Case must be run using T391 in the range (5-30 seconds) and N391 in the range (1-65k). Suggested values for T391 = 5 and N391 = 2																														

12.4 E-LMI Impairments

TEST CASE 64C: Order of Appearance of Information Elements – Protocol Version & Message Type

Abstract Test Suite for E-LMI - Impairments	
Test Name	Order of Appearance of Information Elements – Protocol Version & Message Type
Test Definition ID	UNIC-ELMI-5.5.1-R20 and UNIC-ELMI-5.6.10.4.1-R20
Reference Document	MEF 20 UNI Type 2 Implementation Agreement Section 9 MEF 16 Ethernet Local Management Interface
Test Type	Conformance
Test Status	Mandatory
Requirement Description	There SHALL be particular order of appearance for each Information Element in a message. If the UNI-C receives a message containing an out of sequence IE, it SHALL ignore this Information Element, the procedure SHALL be restarted and there SHALL not be change in the DI
Test Object	Verify that if the UNI-C receives a message containing an out of sequence Information Element, it ignores this IE, the procedure is restarted and there is no change in the DI. (Protocol Version and Message Type are out of sequence)
Test Configuration	Configure UNI “A” CE Side with the default value of N393. Configure UNI “A” MEN Side with the default values of N393 and T392. Tester 1 with proper PHYs that match the UNI “A” MEN side and CE side is monitoring the E-LMI frames
Test Configuration Schematic	<pre> graph LR T2[UNI 'A' MEN Side Tester 2 (Impairment Generator)] --- M[Monitor Mode Tester 1] M --- T1[UNI 'A' CE Side UNI-C Under Test] </pre>
CE-VLAN ID/EVC Map	Not Specified
Bandwidth Profile	Not Specified
Test Procedure	Restart the UNI “A” CE Side and use the tester 1 to monitor the E-LMI messages for a period of time ($T = 3 \times T391$). During the first Full Status procedure use the tester 2 to send a <i>Full Status</i> STATUS message with out of sequence Information Elements (the order of appearance of the Protocol Version and the Message Type is inverted). By analyzing the content of the next STATUS ENQUIRY message transmitted by the UNI “A” CE Side (UNI-C), verify that the out of sequence Information Elements were ignored, that the procedure was restarted and that there is no change in the DI. The Protocol Version and Message Type must be in the right order, the message type must be <i>Full Status</i> and the DI must not be changed.
Units	STATUS ENQUIRY message value
Variables	None
Results	Pass or fail
Remarks	Test Case must be run using T391 in the range (5-30 seconds) and N391 in the range (1-65k). Suggested values for T391 = 5 and N391 = 2

TEST CASE 65C: Order of Appearance of Information Elements – Report Type & Sequence Number

Abstract Test Suite for E-LMI - Impairments	
Test Name	Order of Appearance of Information Elements – Report Type & Sequence Number
Test Definition ID	UNIC-ELMI-5.5.1-R20 and UNIC-ELMI-5.6.10.4.1-R20
Reference Document	MEF 20 UNI Type 2 Implementation Agreement Section 9 MEF 16 Ethernet Local Management Interface
Test Type	Conformance
Test Status	Mandatory
Requirement Description	There SHALL be particular order of appearance for each Information Element in a message. If the UNI-C receives a message containing an out of sequence IE, it SHALL ignore this Information Element, the procedure SHALL be restarted and there SHALL not be change in the DI
Test Object	Verify that if the UNI-C receives a message containing an out of sequence Information Element, it ignores this IE, the procedure is restarted and there is no change in the DI. (Report Type and Sequence Number are out of sequence)
Test Configuration	Configure UNI “A” CE Side with the default value of N393. Configure UNI “A” MEN Side with the default values of N393 and T392. Tester 1 with proper PHYs that match the UNI “A” MEN side and CE side is monitoring the E-LMI frames
Test Configuration Schematic	<pre> graph LR T2[UNI 'A' MEN Side Tester 2 (Impairment Generator)] --- T1[Monitor Mode Tester 1] T1 --- UC[UNI 'A' CE Side UNI-C Under Test] </pre>
CE-VLAN ID/EVC Map	Not Specified
Bandwidth Profile	Not Specified
Test Procedure	Restart the UNI “A” CE Side and use the tester 1 to monitor the E-LMI messages for a period of time ($T = 3 \times T391$). During the first Full Status procedure use the tester 2 to send a <i>Full Status</i> STATUS message with out of sequence Information Elements (the order of appearance of the Report Type and Sequence Number is inverted). By analyzing the content of the next STATUS ENQUIRY message transmitted by the UNI “A” CE Side (UNI-C), verify that the out of sequence Information Elements were ignored, that the procedure was restarted and that there is no change in the DI. The Report Type and Sequence Number must be in the right order, the message type must be <i>Full Status</i> and the DI must not be changed.
Units	STATUS ENQUIRY message value
Variables	None
Results	Pass or fail
Remarks	Test Case must be run using T391 in the range (5-30 seconds) and N391 in the range (1-65k). Suggested values for T391 = 5 and N391 = 2

TEST CASE 66C: Invalid Receive Sequence Number

Abstract Test Suite for E-LMI - Impairments	
Test Name	Invalid Receive Sequence Number
Test Definition ID	UNIC-ELMI-5.6.3-R20
Reference Document	MEF 20 UNI Type 2 Implementation Agreement Section 9 MEF 16 Ethernet Local Management Interface
Test Type	Conformance
Test Status	Mandatory
Requirement Description	When the UNI-C receives a STATUS message from the UNI-N in response to a STATUS ENQUIRY, the UNI-C SHALL check the receive sequence number received from the UNI-N against its send sequence counter. If the values do not match, an error condition SHALL exist and the UNI-C SHALL ignore the message
Test Object	Verify that when the UNI-C receives a STATUS message from the UNI-N in response to a STATUS ENQUIRY, the UNI-C checks the receive sequence number received from the UNI-N against its send sequence counter and if the values do not match, an error condition exists and UNI-C ignores the message
Test Configuration	Configure UNI "A" CE Side with the default value of N393. Configure UNI "A" MEN Side with the default values of N393 and T392. Tester 1 with proper PHYs that match the UNI "A" MEN side and CE side is monitoring the E-LMI frames
Test Configuration Schematic	<pre> graph LR T2[UNI 'A' MEN Side Tester 2 (Impairment Generator)] --- T1[Monitor Mode Tester 1] T1 --- UC[UNI 'A' CE Side UNI-C Under Test] </pre>
CE-VLAN ID/EVC Map	Not Specified
Bandwidth Profile	Not Specified
Test Procedure	Restart the UNI "A" CE Side and use the tester 1 to monitor the E-LMI messages for a period of time ($T = 3 \times T391$). Use the tester 2 to respond to the first STATUS ENQUIRY message sent by the UNI-C with a STATUS message with a wrong receive sequence number and use it to verify that the send Sequence Number of the second STATUS ENQUIRY message sent by the UNI-C is equal to the send Sequence Number of the first STATUS ENQUIRY message sent by the UNI-C meaning that the STATUS message received with a wrong receive Sequence Number was ignored.
Units	UNI-C send and receive sequence numbers
Variables	None
Results	Pass or fail
Remarks	Test Case must be run using T391 in the range (5-30 seconds) and N391 in the range (1-65k). Suggested values for T391 = 5 and N391 = 2

TEST CASE 67C: Active EVC Becoming Not Active

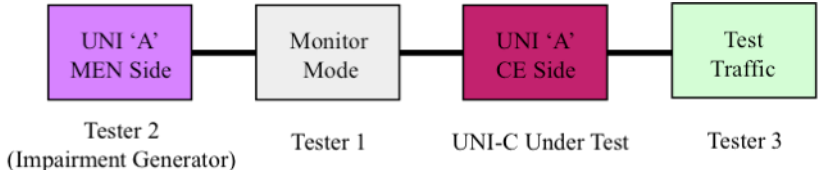
Abstract Test Suite for E-LMI - Impairments													
Test Name	Active EVC Becoming Not Active												
Test Definition ID	UNIC-ELMI-5.6.4-R20 & UNIC-ELMI-5.6.6-R20												
Reference Document	MEF 20 UNI Type 2 Implementation Agreement Section 9 MEF 16 Ethernet Local Management Interface												
Test Type	Conformance												
Test Status	Mandatory												
Requirement Description	If the UNI-C receives an EVC Status Information Element indicating that the EVC is Not Active, the CE SHALL stop transmitting Service Frames on the EVC until it receives the STATUS message indicating that the EVC is Active or Partially Active												
Test Object	Verify that if the UNI-C receives an EVC Status Information Element indicating that the EVC is Not Active, the CE stops transmitting Service Frames on the EVC until it receives the STATUS message indicating that the EVC is Active												
Test Configuration	At least one EVC is simulated by the tester 2 and at least one CE-VLAN ID is mapped to each EVC. A per Ingress UNI bandwidth profile is also simulated at the UNI "A". Configure UNI "A" CE Side with the default values of N393 and T391. Configure UNI "A" MEN Side with the default values of N393 and T392. Tester 1 with proper PHYs that match the UNI "A" MEN side and CE side is monitoring the E-LMI frames. Testers 3 with proper PHYs that match the UNI "A" CE side is transmitting/receiving test traffic												
Test Configuration Schematic													
CE-VLAN ID/EVC Map	<table border="1" style="width: 100%; border-collapse: collapse;"> <thead> <tr> <th colspan="2" style="background-color: #f4a460;">UNI 'A'</th> </tr> <tr> <th style="width: 50%;">CE-VLAN ID</th> <th style="width: 50%;">EVC</th> </tr> </thead> <tbody> <tr> <td style="text-align: center;">11*</td> <td style="text-align: center;">EVC₁</td> </tr> <tr> <td colspan="2">Use of other EVCs or CE-VLAN IDs is permitted provided that the configuration of the CE-VLAN ID/EVC Map conforms to MEF 10.1</td> </tr> <tr> <td colspan="2">The CE-VLAN ID for untagged and priority tagged Service Frames is configured to 11</td> </tr> </tbody> </table>	UNI 'A'		CE-VLAN ID	EVC	11*	EVC ₁	Use of other EVCs or CE-VLAN IDs is permitted provided that the configuration of the CE-VLAN ID/EVC Map conforms to MEF 10.1		The CE-VLAN ID for untagged and priority tagged Service Frames is configured to 11			
UNI 'A'													
CE-VLAN ID	EVC												
11*	EVC ₁												
Use of other EVCs or CE-VLAN IDs is permitted provided that the configuration of the CE-VLAN ID/EVC Map conforms to MEF 10.1													
The CE-VLAN ID for untagged and priority tagged Service Frames is configured to 11													
Bandwidth Profile	<table border="1" style="width: 100%; border-collapse: collapse;"> <thead> <tr> <th colspan="2" style="background-color: #f4a460;">PER INGRESS UNI</th> </tr> <tr> <th style="width: 50%;">UNI</th> <th style="width: 50%;">Bandwidth Profile Parameters</th> </tr> <tr> <th style="background-color: #ffff00;">UNI</th> <th style="background-color: #ffff00;">CIR CBS EIR EBS</th> </tr> </thead> <tbody> <tr> <td colspan="2">Note 1: (0 < CIR < Ingress UNI Speed), (CBS ≥ maximum Service Frame size)</td> </tr> <tr> <td colspan="2">Note 2: (Ingress CIR ≤ Egress UNI Speed)</td> </tr> <tr> <td colspan="2">Note 3: (EIR ≥ 0) and (EBS ≥ 0)</td> </tr> </tbody> </table>	PER INGRESS UNI		UNI	Bandwidth Profile Parameters	UNI	CIR CBS EIR EBS	Note 1: (0 < CIR < Ingress UNI Speed), (CBS ≥ maximum Service Frame size)		Note 2: (Ingress CIR ≤ Egress UNI Speed)		Note 3: (EIR ≥ 0) and (EBS ≥ 0)	
PER INGRESS UNI													
UNI	Bandwidth Profile Parameters												
UNI	CIR CBS EIR EBS												
Note 1: (0 < CIR < Ingress UNI Speed), (CBS ≥ maximum Service Frame size)													
Note 2: (Ingress CIR ≤ Egress UNI Speed)													
Note 3: (EIR ≥ 0) and (EBS ≥ 0)													
Test Procedure	Use tester 3 to transmit/receive test traffic. Restart the UNI "A" CE Side and use the tester 1 to monitor the E-LMI messages for a period of time ($T = 5 \times N391 \times T391$). During the second Full Status procedure use the tester 2 to send a <i>Full Status</i> STATUS message with an EVC Status Information Element indicating that the EVC ₁ is Not Active and verify that the CE stops transmitting Service Frames on EVC ₁ . During the third Full Status procedure use tester 2 again to send another <i>Full Status</i> STATUS message with the same EVC Status Information Element indicating that the EVC is now Active and verify that the CE starts transmitting again												
Units	Mbps												
Variables	None												
Results	Pass or fail												
Remarks	Test Case must be run using T391 in the range (5-30 seconds) and N391 in the range (1-65k). Suggested values for T391 = 5 and N391 = 2												

TEST CASE 68C: Partially Active EVC Becoming Not Active

Abstract Test Suite for E-LMI - Impairments																									
Test Name	Partially Active EVC Becoming Not Active																								
Test Definition ID	UNIC-ELMI-5.6.4-R20 & UNIC-ELMI-5.6.6-R20																								
Reference Document	MEF 20 UNI Type 2 Implementation Agreement Section 9 MEF 16 Ethernet Local Management Interface																								
Test Type	Conformance																								
Test Status	Mandatory																								
Requirement Description	If the UNI-C receives an EVC Status Information Element indicating that the EVC is Not Active, the CE SHALL stop transmitting Service Frames on the EVC until it receives the STATUS message indicating that the EVC is Active or Partially Active																								
Test Object	Verify that if the UNI-C receives an EVC Status Information Element indicating that the EVC is Not Active, the CE stops transmitting Service Frames on the EVC until it receives the STATUS message indicating that the EVC is Partially Active																								
Test Configuration	At least one EVC is simulated by the tester 2 and at least one CE-VLAN ID is mapped to each EVC. A per Ingress UNI bandwidth profile is also simulated at the UNI "A". Configure UNI "A" CE Side with the default values of N393 and T391. Configure UNI "A" MEN Side with the default values of N393 and T392. Tester 1 with proper PHYs that match the UNI "A" MEN side and CE side is monitoring the E-LMI frames. Testers 3 with proper PHYs that match the UNI "A" CE side is transmitting/receiving test traffic																								
Test Configuration Schematic	<pre> graph LR T2[UNI 'A' MEN Side Tester 2 (Impairment Generator)] --- M[Monitor Mode Tester 1] M --- U[UNI 'A' CE Side UNI-C Under Test] U --- T3[Test Traffic Tester 3] </pre>																								
CE-VLAN ID/EVC Map	<table border="1" style="width: 100%; border-collapse: collapse;"> <thead> <tr> <th colspan="2" style="text-align: center;">UNI 'A'</th> </tr> <tr> <th style="text-align: center;">CE-VLAN ID</th> <th style="text-align: center;">EVC</th> </tr> </thead> <tbody> <tr> <td style="text-align: center;">11*</td> <td style="text-align: center;">EVC₁</td> </tr> <tr> <td colspan="2">Use of other EVCs or CE-VLAN IDs is permitted provided that the configuration of the CE-VLAN ID/EVC Map conforms to MEF 10.1</td> </tr> <tr> <td colspan="2">The CE-VLAN ID for untagged and priority tagged Service Frames is configured to 11</td> </tr> </tbody> </table>	UNI 'A'		CE-VLAN ID	EVC	11*	EVC ₁	Use of other EVCs or CE-VLAN IDs is permitted provided that the configuration of the CE-VLAN ID/EVC Map conforms to MEF 10.1		The CE-VLAN ID for untagged and priority tagged Service Frames is configured to 11															
UNI 'A'																									
CE-VLAN ID	EVC																								
11*	EVC ₁																								
Use of other EVCs or CE-VLAN IDs is permitted provided that the configuration of the CE-VLAN ID/EVC Map conforms to MEF 10.1																									
The CE-VLAN ID for untagged and priority tagged Service Frames is configured to 11																									
Bandwidth Profile	<table border="1" style="width: 100%; border-collapse: collapse;"> <thead> <tr> <th colspan="4" style="text-align: center;">PER INGRESS UNI</th> </tr> <tr> <th style="text-align: center;">UNI</th> <th colspan="3" style="text-align: center;">Bandwidth Profile Parameters</th> </tr> <tr> <th style="text-align: center;">UNI</th> <th style="text-align: center;">CIR</th> <th style="text-align: center;">CBS</th> <th style="text-align: center;">EIR EBS</th> </tr> </thead> <tbody> <tr> <td colspan="4">Note 1: (0 < CIR < Ingress UNI Speed), (CBS ≥ maximum Service Frame size)</td> </tr> <tr> <td colspan="4">Note 2: (Ingress CIR ≤ Egress UNI Speed)</td> </tr> <tr> <td colspan="4">Note 3: (EIR ≥ 0) and (EBS ≥ 0)</td> </tr> </tbody> </table>	PER INGRESS UNI				UNI	Bandwidth Profile Parameters			UNI	CIR	CBS	EIR EBS	Note 1: (0 < CIR < Ingress UNI Speed), (CBS ≥ maximum Service Frame size)				Note 2: (Ingress CIR ≤ Egress UNI Speed)				Note 3: (EIR ≥ 0) and (EBS ≥ 0)			
PER INGRESS UNI																									
UNI	Bandwidth Profile Parameters																								
UNI	CIR	CBS	EIR EBS																						
Note 1: (0 < CIR < Ingress UNI Speed), (CBS ≥ maximum Service Frame size)																									
Note 2: (Ingress CIR ≤ Egress UNI Speed)																									
Note 3: (EIR ≥ 0) and (EBS ≥ 0)																									
Test Procedure	Use tester 3 to transmit/receive test traffic. Restart the UNI "A" CE Side and use the tester 1 to monitor the E-LMI messages for a period of time ($T = 5 \times N391 \times T391$). During the second Full Status procedure use the tester 2 to send a <i>Full Status</i> STATUS message with an EVC Status Information Element indicating that the EVC ₁ is Not Active and verify that the CE stops transmitting Service Frames on EVC ₁ . During the third Full Status procedure use tester 2 again to send another <i>Full Status</i> STATUS message with the same EVC Status Information Element indicating that the EVC is now Partially Active and verify that the CE starts transmitting again																								
Units	Mbps																								
Variables	None																								
Results	Pass or fail																								
Remarks	Test Case must be run using T391 in the range (5-30 seconds) and N391 in the range (1-65k). Suggested values for T391 = 5 and N391 = 2																								

TEST CASE 69C: Full Status STATUS Message Receipt - Replace EVC

Abstract Test Suite for E-LMI - Impairments																															
Test Name	Full Status STATUS Message Receipt - Replace EVC																														
Test Definition ID	UNIC-ELMI-5.6.8-R20																														
Reference Document	MEF 20 UNI Type 2 Implementation Agreement Section 9 MEF 16 Ethernet Local Management Interface																														
Test Type	Conformance																														
Test Status	Mandatory if access to the UNI-C list of configured EVCs is possible																														
Requirement Description	When the UNI-C receives a <i>Full Status</i> STATUS message containing an EVC Information Element with the “New” bit of the EVC Status Information Element set to 1 and the UNI-C has an EVC with the same EVC Reference ID in its list of configured EVCs, the UNI-C SHALL delete the EVC from its list and add this new EVC to its list of configured EVCs																														
Test Object	Verify that when the UNI-C receives a <i>Full Status</i> STATUS message containing an EVC Information Element with the “New” bit of the EVC Status Information Element set to 1 and the UNI-C has an EVC with the same EVC Reference ID in its list of configured EVCs, the UNI-C deletes the EVC from its list and adds this new EVC to its list of configured EVCs																														
Test Configuration	At least one EVC is simulated by the tester 2 and at least one CE-VLAN ID is mapped to each EVC. A per Ingress UNI bandwidth profile is also simulated at the UNI “A”. Configure UNI “A” CE Side with the default values of N393 and T391. Configure UNI “A” MEN Side with the default values of N393 and T392. Tester 1 with proper PHYs that match the UNI “A” MEN side and CE side is monitoring the E-LMI frames																														
Test Configuration Schematic	<pre> graph LR T2[Tester 2 (Impairment Generator)] --- U1[UNI 'A' MEN Side] U1 --- MM[Monitor Mode] MM --- U2[UNI 'A' CE Side] subgraph Labels T2 --- T2L[Tester 2 (Impairment Generator)] MM --- T1[Tester 1] U2 --- U2L[UNI-C Under Test] end </pre>																														
CE-VLAN ID/EVC Map	<table border="1" style="width: 100%; border-collapse: collapse;"> <thead> <tr> <th colspan="2" style="text-align: center;">UNI ‘A’</th> </tr> <tr> <th style="text-align: center;">CE-VLAN ID</th> <th style="text-align: center;">EVC</th> </tr> </thead> <tbody> <tr> <td style="text-align: center;">11*</td> <td style="text-align: center;">EVC₁</td> </tr> <tr> <td colspan="2">Use of other EVCs or CE-VLAN IDs is permitted provided that the configuration of the CE-VLAN ID/EVC Map conforms to MEF 10.1</td> </tr> <tr> <td colspan="2">The CE-VLAN ID for untagged and priority tagged Service Frames is configured to 11</td> </tr> </tbody> </table>	UNI ‘A’		CE-VLAN ID	EVC	11*	EVC ₁	Use of other EVCs or CE-VLAN IDs is permitted provided that the configuration of the CE-VLAN ID/EVC Map conforms to MEF 10.1		The CE-VLAN ID for untagged and priority tagged Service Frames is configured to 11																					
UNI ‘A’																															
CE-VLAN ID	EVC																														
11*	EVC ₁																														
Use of other EVCs or CE-VLAN IDs is permitted provided that the configuration of the CE-VLAN ID/EVC Map conforms to MEF 10.1																															
The CE-VLAN ID for untagged and priority tagged Service Frames is configured to 11																															
Bandwidth Profile	<table border="1" style="width: 100%; border-collapse: collapse;"> <thead> <tr> <th colspan="5" style="text-align: center;">PER INGRESS UNI</th> </tr> <tr> <th style="text-align: center;">UNI</th> <th colspan="4" style="text-align: center;">Bandwidth Profile Parameters</th> </tr> <tr> <th style="text-align: center;">UNI</th> <th style="text-align: center;">CIR</th> <th style="text-align: center;">CBS</th> <th style="text-align: center;">EIR</th> <th style="text-align: center;">EBS</th> </tr> </thead> <tbody> <tr> <td colspan="5">Note 1: (0 < CIR < Ingress UNI Speed), (CBS ≥ maximum Service Frame size)</td> </tr> <tr> <td colspan="5">Note 2: (Ingress CIR ≤ Egress UNI Speed)</td> </tr> <tr> <td colspan="5">Note 3: (EIR ≥ 0) and (EBS ≥ 0)</td> </tr> </tbody> </table>	PER INGRESS UNI					UNI	Bandwidth Profile Parameters				UNI	CIR	CBS	EIR	EBS	Note 1: (0 < CIR < Ingress UNI Speed), (CBS ≥ maximum Service Frame size)					Note 2: (Ingress CIR ≤ Egress UNI Speed)					Note 3: (EIR ≥ 0) and (EBS ≥ 0)				
PER INGRESS UNI																															
UNI	Bandwidth Profile Parameters																														
UNI	CIR	CBS	EIR	EBS																											
Note 1: (0 < CIR < Ingress UNI Speed), (CBS ≥ maximum Service Frame size)																															
Note 2: (Ingress CIR ≤ Egress UNI Speed)																															
Note 3: (EIR ≥ 0) and (EBS ≥ 0)																															
Test Procedure	Restart the UNI “A” CE Side and use the tester 1 to monitor the E-LMI messages for a period of time ($T = 5 \times N391 \times T391$). During the second Full Status procedure, use the tester 2 to send a <i>Full Status</i> STATUS message with the “New” bit of the EVC Status Information Element set to 1 and the EVC Reference ID equal to one already used in the UNI “A” CE Side list of configured EVCs. If access to the UNI-C list of configured EVCs is possible, verify that upon the receipt of this <i>Full Status</i> STATUS message, the UNI “A” CE Side (UNI-C) deletes the EVC from its list and adds this new EVC to its list of configured EVCs																														
Units	UNI “A” CE Side list of configured EVCs																														
Variables	None																														
Results	Pass or fail																														
Remarks	Test Case must be run using T391 in the range (5-30 seconds) and N391 in the range (1-65k). Suggested values for T391 = 5 and N391 = 2																														

TEST CASE 70C: Full Status Continued STATUS Message Receipt - Replace EVC

Abstract Test Suite for E-LMI - Impairments																															
Test Name	Full Status Continued STATUS Message Receipt - Replace EVC																														
Test Definition ID	UNIC-ELMI-5.6.8-R20																														
Reference Document	MEF 20 UNI Type 2 Implementation Agreement Section 9 MEF 16 Ethernet Local Management Interface																														
Test Type	Conformance																														
Test Status	Mandatory if access to the UNI-C list of configured EVCs is possible																														
Requirement Description	When the UNI-C receives a <i>Full Status Continued</i> STATUS message containing an EVC Information Element with the “New” bit of the EVC Status Information Element set to 1 and the UNI-C has an EVC with the same EVC Reference ID in its list of configured EVCs, the UNI-C SHALL delete the EVC from its list and add this new EVC to its list of configured EVCs																														
Test Object	Verify that when the UNI-C receives a <i>Full Status Continued</i> STATUS message containing an EVC Information Element with the “New” bit of the EVC Status Information Element set to 1 and the UNI-C has an EVC with the same EVC Reference ID in its list of configured EVCs, the UNI-C deletes the EVC from its list and adds this new EVC to its list of configured EVCs																														
Test Configuration	Multiple EVCs (enough so that the EVC status Information Elements, service attributes and parameters cannot fit into a single <i>Full Status</i> STATUS message) are simulated by the tester 2 and at least one CE-VLAN ID is mapped to each EVC. A per Ingress UNI bandwidth profile is also simulated at the UNI “A”. Configure UNI “A” CE Side with the default values of N393 and T391. Configure UNI “A” MEN Side with the default values of N393 and T392. Tester 1 with proper PHYs that match the UNI “A” MEN side and CE side is monitoring the E-LMI frames																														
Test Configuration Schematic																															
CE-VLAN ID/EVC Map	<table border="1" style="width: 100%; border-collapse: collapse;"> <thead> <tr> <th colspan="2" style="background-color: #f4a460;">UNI ‘A’</th> </tr> <tr> <th style="background-color: #f4a460;">CE-VLAN ID</th> <th style="background-color: #f4a460;">EVC</th> </tr> </thead> <tbody> <tr> <td style="background-color: #ffffcc;">11*</td> <td style="background-color: #ffffcc;">EVC₁</td> </tr> <tr> <td style="background-color: #ffffcc;">12</td> <td style="background-color: #ffffcc;">EVC₂</td> </tr> <tr> <td colspan="2">Use of other EVCs or CE-VLAN IDs is permitted provided that the configuration of the CE-VLAN ID/EVC Map conforms to MEF 10.1</td> </tr> <tr> <td colspan="2">The CE-VLAN ID for untagged and priority tagged Service Frames is configured to 11</td> </tr> </tbody> </table>	UNI ‘A’		CE-VLAN ID	EVC	11*	EVC ₁	12	EVC ₂	Use of other EVCs or CE-VLAN IDs is permitted provided that the configuration of the CE-VLAN ID/EVC Map conforms to MEF 10.1		The CE-VLAN ID for untagged and priority tagged Service Frames is configured to 11																			
UNI ‘A’																															
CE-VLAN ID	EVC																														
11*	EVC ₁																														
12	EVC ₂																														
Use of other EVCs or CE-VLAN IDs is permitted provided that the configuration of the CE-VLAN ID/EVC Map conforms to MEF 10.1																															
The CE-VLAN ID for untagged and priority tagged Service Frames is configured to 11																															
Bandwidth Profile	<table border="1" style="width: 100%; border-collapse: collapse;"> <thead> <tr> <th colspan="5" style="background-color: #f4a460;">PER INGRESS UNI</th> </tr> <tr> <th style="background-color: #f4a460;">UNI</th> <th colspan="4" style="background-color: #f4a460;">Bandwidth Profile Parameters</th> </tr> <tr> <th style="background-color: #ffffcc;">UNI</th> <th style="background-color: #ffffcc;">CIR</th> <th style="background-color: #ffffcc;">CBS</th> <th style="background-color: #ffffcc;">EIR</th> <th style="background-color: #ffffcc;">EBS</th> </tr> </thead> <tbody> <tr> <td colspan="5">Note 1: (0 < CIR < Ingress UNI Speed), (CBS ≥ maximum Service Frame size)</td> </tr> <tr> <td colspan="5">Note 2: (Ingress CIR ≤ Egress UNI Speed)</td> </tr> <tr> <td colspan="5">Note 3: (EIR ≥ 0) and (EBS ≥ 0)</td> </tr> </tbody> </table>	PER INGRESS UNI					UNI	Bandwidth Profile Parameters				UNI	CIR	CBS	EIR	EBS	Note 1: (0 < CIR < Ingress UNI Speed), (CBS ≥ maximum Service Frame size)					Note 2: (Ingress CIR ≤ Egress UNI Speed)					Note 3: (EIR ≥ 0) and (EBS ≥ 0)				
PER INGRESS UNI																															
UNI	Bandwidth Profile Parameters																														
UNI	CIR	CBS	EIR	EBS																											
Note 1: (0 < CIR < Ingress UNI Speed), (CBS ≥ maximum Service Frame size)																															
Note 2: (Ingress CIR ≤ Egress UNI Speed)																															
Note 3: (EIR ≥ 0) and (EBS ≥ 0)																															
Test Procedure	Restart the UNI “A” CE Side and use the tester 1 to monitor the E-LMI messages for a period of time ($T = 5 \times N391 \times T391$). During the second Full Status procedure, use the tester 2 to send a <i>Full Status Continued</i> STATUS message with the “New” bit of the EVC Status Information Element set to 1 and the EVC Reference ID equal to one already used in the UNI “A” CE Side list of configured EVCs. If access to the UNI-C list of configured EVCs is possible, verify that upon the receipt of this <i>Full Status Continued</i> STATUS message, the UNI “A” CE Side (UNI-C) deletes the EVC from its list and adds this new EVC to its list of configured EVCs																														
Units	UNI “A” CE Side list of configured EVCs																														
Variables	None																														
Results	Pass or fail																														
Remarks	Test Case must be run using T391 in the range (5-30 seconds) and N391 in the range (1-65k). Suggested values for T391 = 5 and N391 = 2																														

TEST CASE 72C: Abnormal Expiration of the Polling Timer – Full Status

Abstract Test Suite for E-LMI - Impairments	
Test Name	Abnormal Expiration of the Polling Timer – Full Status
Test Definition ID	UNIC-ELMI-5.6.9.2-R20
Reference Document	MEF 20 UNI Type 2 Implementation Agreement Section 9 MEF 16 Ethernet Local Management Interface
Test Type	Conformance
Test Status	Mandatory
Requirement Description	The expiration of the Polling Timer without having received a response to a STATUS ENQUIRY sent when the Polling Timer was started SHALL be considered an error. If the last message sent before the expiry was a <i>Full Status</i> STATUS ENQUIRY, the <i>Full Status</i> STATUS ENQUIRY procedure SHALL be reinitiated
Test Object	Verify that if the expiration of the Polling Timer happens without having received a response to a STATUS ENQUIRY sent when the Polling Timer was started and if the last message sent before the Poling Timer expiry was a <i>Full Status</i> STATUS ENQUIRY, the <i>Full Status</i> STATUS ENQUIRY procedure is reinitiated
Test Configuration	Configure UNI “A” CE Side with the default value of N393. Configure UNI “A” MEN Side with the default values of N393 and T392. Tester 1 with proper PHYs that match the UNI “A” MEN side and CE side is monitoring the E-LMI frames
Test Configuration Schematic	<pre> graph LR T2[UNI 'A' MEN Side Tester 2 (Impairment Generator)] --- T1[Monitor Mode Tester 1] T1 --- U[UNI 'A' CE Side UNI-C Under Test] </pre>
CE-VLAN ID/EVC Map	Not Specified
Bandwidth Profile	Not Specified
Test Procedure	Restart the UNI “A” CE Side and use the tester 1 to monitor the E-LMI messages for a period of time ($T = 3 \times T391$). Use the tester 2 to not respond to the first <i>Full Status</i> STATUS ENQUIRY messages sent by the UNI-C until the Polling Timer expires and verify that the next STATUS ENQUIRY messages transmitted by the UNI “A” CE Side (UNI-C), is another <i>Full Status</i> STATUS ENQUIRY and therefore, that the Full Status procedure has been reinitiated
Units	Report Type value
Variables	None
Results	Pass or fail
Remarks	Test Case must be run using T391 in the range (5-30 seconds) and N391 in the range (1-65k). Suggested values for T391 = 5 and N391 = 2

TEST CASE 73C: Abnormal Expiration of the Polling Timer – Full Status Continued

Abstract Test Suite for E-LMI - Impairments																															
Test Name	Abnormal Expiration of the Polling Timer – Full Status Continued																														
Test Definition ID	UNIC-ELMI-5.6.9.2-R20																														
Reference Document	MEF 20 UNI Type 2 Implementation Agreement Section 9 MEF 16 Ethernet Local Management Interface																														
Test Type	Conformance																														
Test Status	Mandatory																														
Requirement Description	The expiration of the Polling Timer without having received a response to a STATUS ENQUIRY sent when the Polling Timer was started SHALL be considered an error. If the last message sent before the expiry was a <i>Full Status Continued</i> STATUS ENQUIRY, the <i>Full Status</i> STATUS ENQUIRY procedure SHALL be reinitiated																														
Test Object	Verify that if the expiration of the Polling Timer happens without having received a response to a STATUS ENQUIRY sent when the Polling Timer was started and if the last message sent before the Poling Timer expiry was a <i>Full Status Continued</i> STATUS ENQUIRY, the <i>Full Status</i> STATUS ENQUIRY procedure is reinitiated																														
Test Configuration	Multiple EVCs (enough so that the EVC status Information Elements, service attributes and parameters cannot fit into a single <i>Full Status</i> STATUS message) are simulated by the tester 2 and at least one CE-VLAN ID is mapped to each EVC. A per Ingress UNI bandwidth profile is also simulated at the UNI "A". Configure UNI "A" CE Side with the default value of N393. Configure UNI "A" MEN Side with the default values of N393 and T392. Tester 1 with proper PHYs that match the UNI "A" MEN side and CE side is monitoring the E-LMI frames																														
Test Configuration Schematic																															
CE-VLAN ID/EVC Map	<table border="1" style="width: 100%; border-collapse: collapse;"> <thead> <tr> <th colspan="2" style="text-align: center;">UNI 'A'</th> </tr> <tr> <th style="text-align: center;">CE-VLAN ID</th> <th style="text-align: center;">EVC</th> </tr> </thead> <tbody> <tr> <td style="text-align: center;">11*</td> <td style="text-align: center;">EVC₁</td> </tr> <tr> <td style="text-align: center;">12</td> <td style="text-align: center;">EVC₂</td> </tr> </tbody> </table> <p>Use of other EVCs or CE-VLAN IDs is permitted provided that the configuration of the CE-VLAN ID/EVC Map conforms to MEF 10.1</p> <p>The CE-VLAN ID for untagged and priority tagged Service Frames is configured to 11</p>	UNI 'A'		CE-VLAN ID	EVC	11*	EVC ₁	12	EVC ₂																						
UNI 'A'																															
CE-VLAN ID	EVC																														
11*	EVC ₁																														
12	EVC ₂																														
Bandwidth Profile	<table border="1" style="width: 100%; border-collapse: collapse;"> <thead> <tr> <th colspan="5" style="text-align: center;">PER INGRESS UNI</th> </tr> <tr> <th style="text-align: center;">UNI</th> <th colspan="4" style="text-align: center;">Bandwidth Profile Parameters</th> </tr> <tr> <th style="text-align: center;">UNI</th> <th style="text-align: center;">CIR</th> <th style="text-align: center;">CBS</th> <th style="text-align: center;">EIR</th> <th style="text-align: center;">EBS</th> </tr> </thead> <tbody> <tr> <td colspan="5">Note 1: (0 < CIR < Ingress UNI Speed), (CBS ≥ maximum Service Frame size)</td> </tr> <tr> <td colspan="5">Note 2: (Ingress CIR ≤ Egress UNI Speed)</td> </tr> <tr> <td colspan="5">Note 3: (EIR ≥ 0) and (EBS ≥ 0)</td> </tr> </tbody> </table>	PER INGRESS UNI					UNI	Bandwidth Profile Parameters				UNI	CIR	CBS	EIR	EBS	Note 1: (0 < CIR < Ingress UNI Speed), (CBS ≥ maximum Service Frame size)					Note 2: (Ingress CIR ≤ Egress UNI Speed)					Note 3: (EIR ≥ 0) and (EBS ≥ 0)				
PER INGRESS UNI																															
UNI	Bandwidth Profile Parameters																														
UNI	CIR	CBS	EIR	EBS																											
Note 1: (0 < CIR < Ingress UNI Speed), (CBS ≥ maximum Service Frame size)																															
Note 2: (Ingress CIR ≤ Egress UNI Speed)																															
Note 3: (EIR ≥ 0) and (EBS ≥ 0)																															
Test Procedure	Restart the UNI "A" CE Side and use the tester 1 to monitor the E-LMI messages for a period of time ($T = 5 \times T391$). Use the tester 2 to not respond to the first <i>Full Status Continued</i> STATUS ENQUIRY messages sent by the UNI-C until the Polling Timer expires and verify that the next STATUS ENQUIRY messages transmitted by the UNI "A" CE Side (UNI-C), is a <i>Full Status</i> STATUS ENQUIRY and therefore, that the Full Status procedure has been reinitiated																														
Units	Report Type value																														
Variables	None																														
Results	Pass or fail																														
Remarks	Test Case must be run using T391 in the range (5-30 seconds) and N391 in the range (1-65k). Suggested values for T391 = 5 and N391 = 2																														

TEST CASE 74C: E-LMI Check in Response to Full Status

Abstract Test Suite for E-LMI - Impairments	
Test Name	E-LMI Check in Response to Full Status
Test Definition ID	UNIC-ELMI-5.6.9.2-R20
Reference Document	MEF 20 UNI Type 2 Implementation Agreement Section 9 MEF 16 Ethernet Local Management Interface
Test Type	Conformance
Test Status	Mandatory
Requirement Description	The receipt of a STATUS message with Report Type set to <i>E-LMI Check</i> in response to a STATUS ENQUIRY message with Report Type set to <i>Full Status</i> , the message SHALL be ignored
Test Object	Verify that if a STATUS message with Report Type set to <i>E-LMI Check</i> is received in response to a STATUS ENQUIRY message with Report Type set to <i>Full Status</i> , the STATUS message is ignored
Test Configuration	Configure UNI "A" CE Side with the default value of N393. Configure UNI "A" MEN Side with the default values of N393 and T392. Tester 1 with proper PHYs that match the UNI "A" MEN side and CE side is monitoring the E-LMI frames
Test Configuration Schematic	<pre> graph LR T2[UNI 'A' MEN Side Tester 2 (Impairment Generator)] --- T1[Monitor Mode Tester 1] T1 --- U[UNI 'A' CE Side UNI-C Under Test] </pre>
CE-VLAN ID/EVC Map	Not Specified
Bandwidth Profile	Not Specified
Test Procedure	Restart the UNI "A" CE Side and use the tester 1 to monitor the E-LMI messages for a period of time ($T = 3 \times T391$). Use the tester 2 to respond to the first <i>Full Status</i> STATUS ENQUIRY message sent by the UNI-C by sending an <i>E-LMI Check</i> STATUS message. By analyzing the Sequence Numbers IE of the next STATUS ENQUIRY message transmitted by the UNI "A" CE Side (UNI-C), verify that the <i>E-LMI Check</i> message was ignored. (The send and receive Sequence Numbers of the next STATUS ENQUIRY message transmitted by the UNI "A" CE Side (UNI-C) must be equal to the send and receive Sequence Numbers of the first STATUS ENQUIRY message transmitted by the UNI "A" CE Side (UNI-C))
Units	STATUS ENQUIRY message Sequences Numbers
Variables	None
Results	Pass or fail
Remarks	Test Case must be run using T391 in the range (5-30 seconds) and N391 in the range (1-65k). Suggested values for T391 = 5 and N391 = 2

TEST CASE 75C: E-LMI Check in Response to Full Status Continued

Abstract Test Suite for E-LMI - Impairments																										
Test Name	E-LMI Check in Response to Full Status Continued																									
Test Definition ID	UNIC-ELMI-5.6.9.2-R20																									
Reference Document	MEF 20 UNI Type 2 Implementation Agreement Section 9 MEF 16 Ethernet Local Management Interface																									
Test Type	Conformance																									
Test Status	Mandatory																									
Requirement Description	Receipt of an <i>E-LMI Check</i> STATUS message in response to a <i>Full Status Continued</i> STATUS ENQUIRY SHALL be considered an error. In addition, no <i>Full Status Continued</i> STATUS ENQUIRY message SHALL be issued. At the next Polling Timer expiry, the <i>Full Status</i> STATUS ENQUIRY procedure SHALL be reinitiated (rather than <i>E-LMI Check</i> STATUS ENQUIRY).																									
Test Object	Verify that the receipt of an <i>E-LMI Check</i> STATUS message in response to a <i>Full Status Continued</i> STATUS ENQUIRY is considered an error and that at the next Polling Timer expiry, the <i>Full Status</i> STATUS ENQUIRY procedure is reinitiated rather than <i>E-LMI Check</i> STATUS ENQUIRY																									
Test Configuration	Multiple EVCs (enough so that the EVC status Information Elements, service attributes and parameters cannot fit into a single <i>Full Status</i> STATUS message) are simulated by the tester 2 and at least one CE-VLAN ID is mapped to each EVC. A per Ingress UNI bandwidth profile is also simulated at the UNI "A". Configure UNI "A" CE Side with the default value of N393. Configure UNI "A" MEN Side with the default values of N393 and T392. Tester 1 with proper PHYs that match the UNI "A" MEN side and CE side is monitoring the E-LMI frames																									
Test Configuration Schematic	<pre> graph LR T2[UNI 'A' MEN Side Tester 2 (Impairment Generator)] --- MM[Monitor Mode] MM --- T1[UNI 'A' CE Side Tester 1] T1 --- UCT[UNI-C Under Test] </pre>																									
CE-VLAN ID/EVC Map	<table border="1" style="width: 100%; border-collapse: collapse;"> <thead> <tr> <th colspan="2" style="background-color: #f4a460;">UNI 'A'</th> </tr> <tr> <th style="width: 50%;">CE-VLAN ID</th> <th style="width: 50%;">EVC</th> </tr> </thead> <tbody> <tr> <td style="text-align: center;">11*</td> <td style="text-align: center;">EVC₁</td> </tr> <tr> <td style="text-align: center;">12</td> <td style="text-align: center;">EVC₂</td> </tr> <tr> <td colspan="2">Use of other EVCs or CE-VLAN IDs is permitted provided that the configuration of the CE-VLAN ID/EVC Map conforms to MEF 10.1</td> </tr> <tr> <td colspan="2">The CE-VLAN ID for untagged and priority tagged Service Frames is configured to 11</td> </tr> </tbody> </table>	UNI 'A'		CE-VLAN ID	EVC	11*	EVC ₁	12	EVC ₂	Use of other EVCs or CE-VLAN IDs is permitted provided that the configuration of the CE-VLAN ID/EVC Map conforms to MEF 10.1		The CE-VLAN ID for untagged and priority tagged Service Frames is configured to 11														
UNI 'A'																										
CE-VLAN ID	EVC																									
11*	EVC ₁																									
12	EVC ₂																									
Use of other EVCs or CE-VLAN IDs is permitted provided that the configuration of the CE-VLAN ID/EVC Map conforms to MEF 10.1																										
The CE-VLAN ID for untagged and priority tagged Service Frames is configured to 11																										
Bandwidth Profile	<table border="1" style="width: 100%; border-collapse: collapse;"> <thead> <tr> <th colspan="5" style="background-color: #f4a460;">PER INGRESS UNI</th> </tr> <tr> <th style="width: 50%;">UNI</th> <th colspan="4" style="width: 50%;">Bandwidth Profile Parameters</th> </tr> <tr> <th style="background-color: #ffff00;">UNI</th> <th style="background-color: #ffff00;">CIR</th> <th style="background-color: #ffff00;">CBS</th> <th style="background-color: #ffff00;">EIR</th> <th style="background-color: #ffff00;">EBS</th> </tr> </thead> <tbody> <tr> <td colspan="5">Note 1: (0 < CIR < Ingress UNI Speed), (CBS ≥ maximum Service Frame size)</td> </tr> <tr> <td colspan="5">Note 2: (Ingress CIR ≤ Egress UNI Speed) Note 3: (EIR ≥ 0) and (EBS ≥ 0)</td> </tr> </tbody> </table>	PER INGRESS UNI					UNI	Bandwidth Profile Parameters				UNI	CIR	CBS	EIR	EBS	Note 1: (0 < CIR < Ingress UNI Speed), (CBS ≥ maximum Service Frame size)					Note 2: (Ingress CIR ≤ Egress UNI Speed) Note 3: (EIR ≥ 0) and (EBS ≥ 0)				
PER INGRESS UNI																										
UNI	Bandwidth Profile Parameters																									
UNI	CIR	CBS	EIR	EBS																						
Note 1: (0 < CIR < Ingress UNI Speed), (CBS ≥ maximum Service Frame size)																										
Note 2: (Ingress CIR ≤ Egress UNI Speed) Note 3: (EIR ≥ 0) and (EBS ≥ 0)																										
Test Procedure	Restart the UNI "A" CE Side and use the tester 1 to monitor the E-LMI messages for a period of time ($T = 3 \times T391$). Use the tester 2 to respond to the first <i>Full Status Continued</i> STATUS ENQUIRY message sent by the UNI-C by sending an <i>E-LMI Check</i> STATUS message. Verify that no <i>Full Status Continued</i> STATUS ENQUIRY message is issued. At the Polling Timer expiry, verify that the next STATUS ENQUIRY message transmitted by the UNI "A" CE Side (UNI-C) is a <i>Full Status</i> STATUS ENQUIRY rather than <i>E-LMI Check</i> STATUS ENQUIRY																									
Units	STATUS ENQUIRY Report Type																									
Variables	None																									
Results	Pass or fail																									
Remarks	Test Case must be run using T391 in the range (5-30 seconds) and N391 in the range (1-65k). Suggested values for T391 = 5 and N391 = 2																									

TEST CASE 76C: Receipt of an unsolicited E-LMI Check STATUS message

Abstract Test Suite for E-LMI - Impairments	
Test Name	Receipt of an unsolicited E-LMI Check STATUS message
Test Definition ID	UNIC-ELMI-5.6.9.2-R20
Reference Document	MEF 20 UNI Type 2 Implementation Agreement Section 9 MEF 16 Ethernet Local Management Interface
Test Type	Conformance
Test Status	Mandatory
Requirement Description	The receipt of an unsolicited STATUS message with Report Type set to <i>E-LMI Check</i> SHALL be considered an error and the message SHALL be ignored
Test Object	Verify that the receipt of an unsolicited STATUS message with Report Type set to <i>E-LMI Check</i> is considered an error and the message is ignored
Test Configuration	Configure UNI "A" CE Side with the default value of N393. Configure UNI "A" MEN Side with the default values of N393 and T392. Tester 1 with proper PHYs that match the UNI "A" MEN side and CE side is monitoring the E-LMI frames
Test Configuration Schematic	<pre> graph LR T2[UNI 'A' MEN Side Tester 2 (Impairment Generator)] --- T1[Monitor Mode Tester 1] T1 --- U[UNI 'A' CE Side UNI-C Under Test] </pre>
CE-VLAN ID/EVC Map	Not Specified
Bandwidth Profile	Not Specified
Test Procedure	Restart the UNI "A" CE Side and use the tester 1 to monitor the E-LMI messages for a period of time ($T = 3 \times T391$). Use the tester 2 to respond to the first <i>Full Status</i> STATUS ENQUIRY message sent by the UNI-C by sending a <i>Full Status</i> STATUS message follow by an unsolicited <i>E-LMI Check</i> STATUS message with an incremented send Sequence Number. By analyzing the Sequence Number IE of the next STATUS ENQUIRY message transmitted by the UNI "A" CE Side (UNI-C), verify that the unsolicited <i>E-LMI Check STATUS</i> message with the incremented send Sequence Number was ignored. The send Sequence Number of the next STATUS ENQUIRY message transmitted by the UNI "A" CE Side (UNI-C) must be incremented from the send Sequence Numbers of the first STATUS ENQUIRY message transmitted by the UNI "A" CE Side (UNI-C) and the receive Sequence Number of the next STATUS ENQUIRY message transmitted by the UNI "A" CE Side (UNI-C) must be equal to the send Sequence Number of the <i>Full Status</i> STATUS message transmitted by the tester 2, not equal to the send Sequence Numbers of the unsolicited <i>E-LMI Check</i> STATUS message transmitted by the tester 2
Units	STATUS ENQUIRY message Sequence Numbers
Variables	None
Results	Pass or fail
Remarks	Test Case must be run using T391 in the range (5-30 seconds) and N391 in the range (1-65k). Suggested values for T391 = 5 and N391 = 2

TEST CASE 77C: Receipt of an unsolicited Full Status STATUS message

Abstract Test Suite for E-LMI - Impairments	
Test Name	Receipt of an unsolicited <i>Full Status</i> STATUS message
Test Definition ID	UNIC-ELMI-5.6.9.2-R20
Reference Document	MEF 20 UNI Type 2 Implementation Agreement Section 9 MEF 16 Ethernet Local Management Interface
Test Type	Conformance
Test Status	Mandatory
Requirement Description	The receipt of an unsolicited STATUS message with Report Type set to <i>Full Status</i> SHALL be considered an error and the message SHALL be ignored
Test Object	Verify that the receipt of an unsolicited STATUS message with Report Type set to <i>Full Status</i> is considered an error and the message is ignored
Test Configuration	Configure UNI "A" CE Side with the default value of N393. Configure UNI "A" MEN Side with the default values of N393 and T392. Tester 1 with proper PHYs that match the UNI "A" MEN side and CE side are impairing and monitoring the E-LMI frames
Test Configuration Schematic	<pre> graph LR T2[UNI 'A' MEN Side Tester 2 (Impairment Generator)] --- T1[Monitor Mode Tester 1] T1 --- UT[UNI 'A' CE Side UNI-C Under Test] </pre>
CE-VLAN ID/EVC Map	Not Specified
Bandwidth Profile	Not Specified
Test Procedure	Restart the UNI "A" CE Side and use the tester 1 to monitor the E-LMI messages for a period of time ($T = 3 \times T391$). Use the tester 2 to respond to the first <i>Full Status</i> STATUS ENQUIRY message sent by the UNI-C by sending a <i>Full Status</i> STATUS message follow by an unsolicited <i>Full Status</i> STATUS message with an incremented send Sequence Number. By analyzing the Sequence Number IE of the next STATUS ENQUIRY message transmitted by the UNI "A" CE Side (UNI-C), verify that the unsolicited <i>Full Status</i> STATUS message with the incremented send Sequence Number was ignored. The send Sequence Number of the next STATUS ENQUIRY message transmitted by the UNI "A" CE Side (UNI-C) must be incremented from the send Sequence Numbers of the first STATUS ENQUIRY message transmitted by the UNI "A" CE Side (UNI-C) and the receive Sequence Number of the next STATUS ENQUIRY message transmitted by the UNI "A" CE Side (UNI-C) must be equal to the send Sequence Number of the first <i>Full Status</i> STATUS message transmitted by the tester 2, not equal to the send Sequence Numbers of the unsolicited <i>Full Status</i> STATUS message transmitted by the tester 2
Units	STATUS ENQUIRY message Sequence Numbers
Variables	None
Results	Pass or fail
Remarks	Test Case must be run using T391 in the range (5-30 seconds) and N391 in the range (1-65k). Suggested values for T391 = 5 and N391 = 2

TEST CASE 78C: Receipt of an unsolicited Full Status Continued STATUS message

Abstract Test Suite for E-LMI - Impairments	
Test Name	Receipt of an unsolicited <i>Full Status Continued</i> STATUS message
Test Definition ID	UNIC-ELMI-5.6.9.2-R20
Reference Document	MEF 20 UNI Type 2 Implementation Agreement Section 9 MEF 16 Ethernet Local Management Interface
Test Type	Conformance
Test Status	Mandatory
Requirement Description	The receipt of an unsolicited STATUS message with Report Type set to <i>Full Status Continued</i> SHALL be considered an error and the message SHALL be ignored
Test Object	Verify that the receipt of an unsolicited STATUS message with Report Type set to <i>Full Status Continued</i> is considered an error and the message is ignored
Test Configuration	Configure UNI "A" CE Side with the default value of N393. Configure UNI "A" MEN Side with the default values of N393 and T392. Tester 1 with proper PHYs that match the UNI "A" MEN side and CE side are impairing and monitoring the E-LMI frames
Test Configuration Schematic	<pre> graph LR T2[UNI 'A' MEN Side Tester 2 (Impairment Generator)] --- T1[Monitor Mode Tester 1] T1 --- U[UNI 'A' CE Side UNI-C Under Test] </pre>
CE-VLAN ID/EVC Map	Not Specified
Bandwidth Profile	Not Specified
Test Procedure	Restart the UNI "A" CE Side and use the tester 1 to monitor the E-LMI messages for a period of time ($T = 3 \times T391$). Use the tester 2 to respond to the first <i>Full Status</i> STATUS ENQUIRY message sent by the UNI-C by sending a <i>Full Status</i> STATUS message follow by an unsolicited <i>Full Status Continued</i> STATUS message with an incremented send Sequence Number. By analyzing the Sequence Number IE of the next STATUS ENQUIRY message transmitted by the UNI "A" CE Side (UNI-C), verify that the unsolicited <i>Full Status Continued</i> STATUS message with the incremented send Sequence Number was ignored. The send Sequence Number of the next STATUS ENQUIRY message transmitted by the UNI "A" CE Side (UNI-C) must be incremented from the send Sequence Numbers of the first STATUS ENQUIRY message transmitted by the UNI "A" CE Side (UNI-C) and the receive Sequence Number of the next STATUS ENQUIRY message transmitted by the UNI "A" CE Side (UNI-C) must be equal to the send Sequence Number of the <i>Full Status</i> STATUS message transmitted by the tester 2, not equal to the send Sequence Numbers of the unsolicited <i>Full Status Continued</i> STATUS message transmitted by the tester 2
Units	STATUS ENQUIRY message Sequence Numbers
Variables	None
Results	Pass or fail
Remarks	Test Case must be run using T391 in the range (5-30 seconds) and N391 in the range (1-65k). Suggested values for T391 = 5 and N391 = 2

TEST CASE 79C: Lower-Valued EVC Reference ID – Full Status

Abstract Test Suite for E-LMI - Impairments																															
Test Name	Lower-Valued EVC Reference ID – <i>Full Status</i>																														
Test Definition ID	UNIC-ELMI-5.6.9.2-R20																														
Reference Document	MEF 20 UNI Type 2 Implementation Agreement Section 9 MEF 16 Ethernet Local Management Interface																														
Test Type	Conformance																														
Test Status	Mandatory if access to the UNI-C list of configured EVCs is possible																														
Requirement Description	If a <i>Full Status</i> or <i>Full Status Continued</i> STATUS response message to a <i>Full Status Continued</i> STATUS ENQUIRY message indicates a lower-valued EVC Reference ID than the highest reported in the previous <i>Full Status Continued</i> STATUS message, the UNI-C SHALL consider this an error and the message SHALL be ignored																														
Test Object	Verify that if a <i>Full Status</i> STATUS response message to a <i>Full Status Continued</i> STATUS ENQUIRY message indicates a lower-valued EVC Reference ID than the highest reported in the previous <i>Full Status Continued</i> STATUS message, the UNI-C considers this an error and the message is ignored																														
Test Configuration	Multiple EVCs (enough so that the EVC status Information Elements, service attributes and parameters cannot fit into a single <i>Full Status</i> STATUS message) are simulated by the tester 2 and at least one CE-VLAN ID is mapped to each EVC. A per Ingress UNI bandwidth profile is also simulated at the UNI "A". Configure UNI "A" CE Side with the default value of N393. Configure UNI "A" MEN Side with the default values of N393 and T392. Tester 1 with proper PHYs that match the UNI "A" MEN side and CE side is monitoring the E-LMI frames																														
Test Configuration Schematic																															
CE-VLAN ID/EVC Map	<table border="1"> <thead> <tr> <th colspan="2">UNI "A"</th> </tr> <tr> <th>CE-VLAN ID</th> <th>EVC</th> </tr> </thead> <tbody> <tr> <td>11*</td> <td>EVC₁</td> </tr> <tr> <td>12</td> <td>EVC₂</td> </tr> </tbody> </table> <p>Use of other EVCs or CE-VLAN IDs is permitted provided that the configuration of the CE-VLAN ID/EVC Map conforms to MEF 10.1</p> <p>The CE-VLAN ID for untagged and priority tagged Service Frames is configured to 11</p>	UNI "A"		CE-VLAN ID	EVC	11*	EVC ₁	12	EVC ₂																						
UNI "A"																															
CE-VLAN ID	EVC																														
11*	EVC ₁																														
12	EVC ₂																														
Bandwidth Profile	<table border="1"> <thead> <tr> <th colspan="5">PER INGRESS UNI</th> </tr> <tr> <th>UNI</th> <th colspan="4">Bandwidth Profile Parameters</th> </tr> <tr> <th>UNI</th> <th>CIR</th> <th>CBS</th> <th>EIR</th> <th>EBS</th> </tr> </thead> <tbody> <tr> <td colspan="5">Note 1: (0 < CIR < Ingress UNI Speed), (CBS ≥ maximum Service Frame size)</td> </tr> <tr> <td colspan="5">Note 2: (Ingress CIR ≤ Egress UNI Speed)</td> </tr> <tr> <td colspan="5">Note 3: (EIR ≥ 0) and (EBS ≥ 0)</td> </tr> </tbody> </table>	PER INGRESS UNI					UNI	Bandwidth Profile Parameters				UNI	CIR	CBS	EIR	EBS	Note 1: (0 < CIR < Ingress UNI Speed), (CBS ≥ maximum Service Frame size)					Note 2: (Ingress CIR ≤ Egress UNI Speed)					Note 3: (EIR ≥ 0) and (EBS ≥ 0)				
PER INGRESS UNI																															
UNI	Bandwidth Profile Parameters																														
UNI	CIR	CBS	EIR	EBS																											
Note 1: (0 < CIR < Ingress UNI Speed), (CBS ≥ maximum Service Frame size)																															
Note 2: (Ingress CIR ≤ Egress UNI Speed)																															
Note 3: (EIR ≥ 0) and (EBS ≥ 0)																															
Test Procedure	Restart the UNI "A" CE Side and use the tester 1 to monitor the E-LMI messages for a period of time ($T = 3 \times T391$). Use the tester 2 to respond to the first <i>Full Status Continued</i> STATUS ENQUIRY message sent by the UNI "A" CE Side (UNI-C) by sending a <i>Full Status</i> STATUS message including a new EVC with an EVC Reference ID with a lower value than the highest reported in the previous <i>Full Status Continued</i> STATUS message. If access to the UNI-C list of configured EVCs is possible, verify that upon the receipt of this <i>Full Status</i> STATUS message, the UNI "A" CE Side (UNI-C) ignores it and does not add the EVC to its list of configured EVCs.																														
Units	UNI "A" CE Side list of configured EVCs																														
Variables	None																														
Results	Pass or fail																														
Remarks	Test Case must be run using T391 in the range (5-30 seconds) and N391 in the range (1-65k). Suggested values for T391 = 5 and N391 = 2																														

TEST CASE 80C: Lower-Valued EVC Reference ID – Full Status Continued

Abstract Test Suite for E-LMI - Impairments																															
Test Name	Lower-Valued EVC Reference ID – <i>Full Status Continued</i>																														
Test Definition ID	UNIC-ELMI-5.6.9.2-R20																														
Reference Document	MEF 20 UNI Type 2 Implementation Agreement Section 9 MEF 16 Ethernet Local Management Interface																														
Test Type	Conformance																														
Test Status	Mandatory if access to the UNI-C list of configured EVCs is possible																														
Requirement Description	If a <i>Full Status</i> or <i>Full Status Continued</i> STATUS response message to a <i>Full Status Continued</i> STATUS ENQUIRY message indicates a lower-valued EVC Reference ID than the highest reported in the previous <i>Full Status Continued</i> STATUS message, the UNI-C SHALL consider this an error and the message SHALL be ignored																														
Test Object	Verify that if a <i>Full Status Continued</i> STATUS response message to a <i>Full Status Continued</i> STATUS ENQUIRY message indicates a lower-valued EVC Reference ID than the highest reported in the previous <i>Full Status Continued</i> STATUS message, the UNI-C considers this an error and the message is ignored																														
Test Configuration	Multiple EVCs (enough so that the EVC status Information Elements, service attributes and parameters cannot fit into a single <i>Full Status</i> STATUS message) are simulated by the tester 2 and at least one CE-VLAN ID is mapped to each EVC. A per Ingress UNI bandwidth profile is also simulated at the UNI “A”. Configure UNI “A” CE Side with the default value of N393. Configure UNI “A” MEN Side with the default values of N393 and T392. Tester 1 with proper PHYs that match the UNI “A” MEN side and CE side is monitoring the E-LMI frames																														
Test Configuration Schematic																															
CE-VLAN ID/EVC Map	<table border="1"> <thead> <tr> <th colspan="2">UNI ‘A’</th> </tr> <tr> <th>CE-VLAN ID</th> <th>EVC</th> </tr> </thead> <tbody> <tr> <td>11*</td> <td>EVC₁</td> </tr> <tr> <td>12</td> <td>EVC₂</td> </tr> </tbody> </table> <p>Use of other EVCs or CE-VLAN IDs is permitted provided that the configuration of the CE-VLAN ID/EVC Map conforms to MEF 10.1</p> <p>The CE-VLAN ID for untagged and priority tagged Service Frames is configured to 11</p>	UNI ‘A’		CE-VLAN ID	EVC	11*	EVC ₁	12	EVC ₂																						
UNI ‘A’																															
CE-VLAN ID	EVC																														
11*	EVC ₁																														
12	EVC ₂																														
Bandwidth Profile	<table border="1"> <thead> <tr> <th colspan="5">PER INGRESS UNI</th> </tr> <tr> <th>UNI</th> <th colspan="4">Bandwidth Profile Parameters</th> </tr> <tr> <th>UNI</th> <th>CIR</th> <th>CBS</th> <th>EIR</th> <th>EBS</th> </tr> </thead> <tbody> <tr> <td colspan="5">Note 1: (0 < CIR < Ingress UNI Speed), (CBS ≥ maximum Service Frame size)</td> </tr> <tr> <td colspan="5">Note 2: (Ingress CIR ≤ Egress UNI Speed)</td> </tr> <tr> <td colspan="5">Note 3: (EIR ≥ 0) and (EBS ≥ 0)</td> </tr> </tbody> </table>	PER INGRESS UNI					UNI	Bandwidth Profile Parameters				UNI	CIR	CBS	EIR	EBS	Note 1: (0 < CIR < Ingress UNI Speed), (CBS ≥ maximum Service Frame size)					Note 2: (Ingress CIR ≤ Egress UNI Speed)					Note 3: (EIR ≥ 0) and (EBS ≥ 0)				
PER INGRESS UNI																															
UNI	Bandwidth Profile Parameters																														
UNI	CIR	CBS	EIR	EBS																											
Note 1: (0 < CIR < Ingress UNI Speed), (CBS ≥ maximum Service Frame size)																															
Note 2: (Ingress CIR ≤ Egress UNI Speed)																															
Note 3: (EIR ≥ 0) and (EBS ≥ 0)																															
Test Procedure	Restart the UNI “A” CE Side and use the tester 1 to monitor the E-LMI messages for a period of time ($T = 3 \times T391$). Use the tester 2 to respond to the first <i>Full Status Continued</i> STATUS ENQUIRY message sent by the UNI “A” CE Side (UNI-C) by sending a <i>Full Status Continued</i> STATUS message including a new EVC with an EVC Reference ID with a lower value than the highest reported in the previous <i>Full Status Continued</i> STATUS message. If access to the UNI-C list of configured EVCs is possible, verify that upon the receipt of this <i>Full Status Continued</i> STATUS message, the UNI “A” CE Side (UNI-C) ignores it and does not add the EVC to its list of configured EVCs.																														
Units	UNI “A” CE Side list of configured EVCs																														
Variables	None																														
Results	Pass or fail																														
Remarks	Test Case must be run using T391 in the range (5-30 seconds) and N391 in the range (1-65k). Suggested values for T391 = 5 and N391 = 2																														

TEST CASE 81C: EVC Not Currently Defined

Abstract Test Suite for E-LMI - Impairments													
Test Name	EVC Not Currently Defined												
Test Definition ID	UNIC-ELMI-5.6.9.2-R20												
Reference Document	MEF 20 UNI Type 2 Implementation Agreement Section 9 MEF 16 Ethernet Local Management Interface												
Test Type	Conformance												
Test Status	Mandatory if access to the UNI-C list of configured EVCs and list of errors is possible												
Requirement Description	If the UNI-C receives an EVC Status Information Element for an EVC not currently defined and the "Active" bit is set to 1, the UNI-C SHALL record this as an error and add the EVC to the active EVCs												
Test Object	Verify that if the UNI-C receives an EVC Status Information Element for an EVC not currently defined and the "Active" bit is set to 1, the UNI-C records this as an error and add the EVC to the active EVCs												
Test Configuration	At least one EVC is simulated by the tester 2 and at least one CE-VLAN ID is mapped to each EVC. A per Ingress UNI bandwidth profile is also simulated at the UNI "A". Configure UNI "A" CE Side with the default value of N393. Configure UNI "A" MEN Side with the default values of N393 and T392. Tester 1 with proper PHYs that match the UNI "A" MEN side and CE side is monitoring the E-LMI frames												
Test Configuration Schematic													
CE-VLAN ID/EVC Map	<table border="1" style="width: 100%; border-collapse: collapse;"> <thead> <tr> <th colspan="2" style="text-align: center;">UNI 'A'</th> </tr> <tr> <th style="text-align: center;">CE-VLAN ID</th> <th style="text-align: center;">EVC</th> </tr> </thead> <tbody> <tr> <td style="text-align: center;">11*</td> <td style="text-align: center;">EVC₁</td> </tr> <tr> <td colspan="2">Use of other EVCs or CE-VLAN IDs is permitted provided that the configuration of the CE-VLAN ID/EVC Map conforms to MEF 10.1</td> </tr> <tr> <td colspan="2">The CE-VLAN ID for untagged and priority tagged Service Frames is configured to 11</td> </tr> </tbody> </table>	UNI 'A'		CE-VLAN ID	EVC	11*	EVC ₁	Use of other EVCs or CE-VLAN IDs is permitted provided that the configuration of the CE-VLAN ID/EVC Map conforms to MEF 10.1		The CE-VLAN ID for untagged and priority tagged Service Frames is configured to 11			
UNI 'A'													
CE-VLAN ID	EVC												
11*	EVC ₁												
Use of other EVCs or CE-VLAN IDs is permitted provided that the configuration of the CE-VLAN ID/EVC Map conforms to MEF 10.1													
The CE-VLAN ID for untagged and priority tagged Service Frames is configured to 11													
Bandwidth Profile	<table border="1" style="width: 100%; border-collapse: collapse;"> <thead> <tr> <th colspan="2" style="text-align: center;">PER INGRESS UNI</th> </tr> <tr> <th style="text-align: center;">UNI</th> <th style="text-align: center;">Bandwidth Profile Parameters</th> </tr> </thead> <tbody> <tr> <td style="text-align: center;">UNI</td> <td style="text-align: center;">CIR CBS EIR EBS</td> </tr> <tr> <td colspan="2">Note 1: (0 < CIR < Ingress UNI Speed), (CBS ≥ maximum Service Frame size)</td> </tr> <tr> <td colspan="2">Note 2: (Ingress CIR ≤ Egress UNI Speed)</td> </tr> <tr> <td colspan="2">Note 3: (EIR ≥ 0) and (EBS ≥ 0)</td> </tr> </tbody> </table>	PER INGRESS UNI		UNI	Bandwidth Profile Parameters	UNI	CIR CBS EIR EBS	Note 1: (0 < CIR < Ingress UNI Speed), (CBS ≥ maximum Service Frame size)		Note 2: (Ingress CIR ≤ Egress UNI Speed)		Note 3: (EIR ≥ 0) and (EBS ≥ 0)	
PER INGRESS UNI													
UNI	Bandwidth Profile Parameters												
UNI	CIR CBS EIR EBS												
Note 1: (0 < CIR < Ingress UNI Speed), (CBS ≥ maximum Service Frame size)													
Note 2: (Ingress CIR ≤ Egress UNI Speed)													
Note 3: (EIR ≥ 0) and (EBS ≥ 0)													
Test Procedure	Restart the UNI "A" CE Side and use the tester 1 to monitor the E-LMI messages for a period of time ($T = 3 \times T391$). During the second Full Status procedure use the tester 2 to send a <i>Full Status</i> STATUS message including an EVC Status Information Element for an EVC that is not currently defined with the "Active" bit set to 1, If access to the UNI-C list of configured EVCs and to the list of errors is possible verify that the UNI "A" CE Side (UNI-C) has recorded an error and added the new EVC to its list of active EVCs												
Units	UNI "A" CE Side list of configured EVCs and list of errors												
Variables	None												
Results	Pass or fail												
Remarks	Test Case must be run using T391 in the range (5-30 seconds) and N391 in the range (1-65k). Suggested values for T391 = 5 and N391 = 2												

TEST CASE 82C: Protocol Version Error

Abstract Test Suite for E-LMI - Impairments	
Test Name	Protocol Version Error
Test Definition ID	UNIC-ELMI-5.6.10.1-R20
Reference Document	MEF 20 UNI Type 2 Implementation Agreement Section 9 MEF 16 Ethernet Local Management Interface
Test Type	Conformance
Test Status	Mandatory
Requirement Description	When a message is received with a protocol version coded other than (0000 0001), the message SHALL be ignored
Test Object	Verify that when a message is received with a protocol version coded other than (0000 0001), the message is ignored
Test Configuration	Configure UNI "A" CE Side with the default value of N393. Configure UNI "A" MEN Side with the default values of N393 and T392. Tester 1 with proper PHYs that match the UNI "A" MEN side and CE side are impairing and monitoring the E-LMI frames
Test Configuration Schematic	<pre> graph LR T2[UNI 'A' MEN Side Tester 2 (Impairment Generator)] --- T1[Monitor Mode Tester 1] T1 --- UCT[UNI 'A' CE Side UNI-C Under Test] </pre>
CE-VLAN ID/EVC Map	Not Specified
Bandwidth Profile	Not Specified
Test Procedure	Restart the UNI "A" CE Side and use the tester 1 to monitor the E-LMI messages for a period of time ($T = 3 \times T391$). Use the tester 2 to respond to the first <i>Full Status</i> STATUS ENQUIRY message sent by the UNI-C by sending a <i>Full Status</i> STATUS message with a protocol version coded other than 0000 0001 (for example 0000 0011). By analyzing the Sequence Numbers IE of the next STATUS ENQUIRY message transmitted by the UNI "A" CE Side (UNI-C), verify that the <i>Full Status</i> STATUS message with a protocol version coded other than (0000 0001) was ignored. (The send and receive Sequence Numbers of the next STATUS ENQUIRY message transmitted by the UNI "A" CE Side (UNI-C) must be equal to the send and receive Sequence Numbers of the first STATUS ENQUIRY message transmitted by the UNI "A" CE Side (UNI-C))
Units	STATUS ENQUIRY message Sequence Number
Variables	Protocol Version value
Results	Pass or fail
Remarks	Test Case must be run using T391 in the range (5-30 seconds) and N391 in the range (1-65k). Suggested values for T391 = 5 and N391 = 2

TEST CASE 83C: Message Too Short

Abstract Test Suite for E-LMI - Impairments	
Test Name	Message Too Short
Test Definition ID	UNIC-ELMI-5.6.10.2-R20
Reference Document	MEF 20 UNI Type 2 Implementation Agreement Section 9 MEF 16 Ethernet Local Management Interface
Test Type	Conformance
Test Status	Mandatory
Requirement Description	When a message received is too short to contain a complete message type Information Element, that message SHALL be ignored
Test Object	Verify that when a message received is too short to contain a complete message type Information Element, that message is ignored
Test Configuration	Configure UNI "A" CE Side with the default value of N393. Configure UNI "A" MEN Side with the default values of N393 and T392. Tester 1 with proper PHYs that match the UNI "A" MEN side and CE side is monitoring the E-LMI frames
Test Configuration Schematic	
CE-VLAN ID/EVC Map	Not Specified
Bandwidth Profile	Not Specified
Test Procedure	Restart the UNI "A" CE Side and use the tester 1 to monitor the E-LMI messages for a period of time ($T = 3 \times T391$). Use the tester 2 to respond to the first <i>Full Status</i> STATUS ENQUIRY message sent by the UNI-C by sending a <i>Full Status</i> STATUS message that is too short to contain the complete message type Information Element. By analyzing the Sequence Numbers IE of the next STATUS ENQUIRY message transmitted by the UNI "A" CE Side (UNI-C), verify that the <i>Full Status</i> STATUS message too short to contain the complete message type Information Element was ignored. (The send and receive Sequence Numbers of the next STATUS ENQUIRY message transmitted by the UNI "A" CE Side (UNI-C) must be equal to the send and receive Sequence Numbers of the first STATUS ENQUIRY message transmitted by the UNI "A" CE Side (UNI-C))
Units	STATUS ENQUIRY message Sequence Number
Variables	None
Results	Pass or fail
Remarks	Test Case must be run using T391 in the range (5-30 seconds) and N391 in the range (1-65k). Suggested values for T391 = 5 and N391 = 2

TEST CASE 84C: Message Type Errors

Abstract Test Suite for E-LMI - Impairments	
Test Name	Message Type Errors
Test Definition ID	UNIC-ELMI-5.6.10.3-R20
Reference Document	MEF 20 UNI Type 2 Implementation Agreement Section 9 MEF 16 Ethernet Local Management Interface
Test Type	Conformance
Test Status	Mandatory
Requirement Description	When an E-LMI message is received that specifies a message type which is not recognized, the E-LMI message SHALL be ignored
Test Object	Verify that when an E-LMI message is received that specifies a message type which is not recognized, the E-LMI message is ignored
Test Configuration	Configure UNI "A" CE Side with the default value of N393. Configure UNI "A" MEN Side with the default values of N393 and T392. Tester 1 with proper PHYs that match the UNI "A" MEN side and CE side is monitoring the E-LMI frames
Test Configuration Schematic	<pre> graph LR T2[UNI 'A' MEN Side Tester 2 (Impairment Generator)] --- M[Monitor Mode Tester 1] M --- T1[UNI 'A' CE Side UNI-C Under Test] </pre>
CE-VLAN ID/EVC Map	Not Specified
Bandwidth Profile	Not Specified
Test Procedure	Restart the UNI "A" CE Side and use the tester 1 to monitor the E-LMI messages for a period of time ($T = 3 \times T391$). Use the tester 2 to respond to the first <i>Full Status</i> STATUS ENQUIRY message sent by the UNI-C by sending a <i>Full Status</i> STATUS message with a message type that is not defined (for example: 01111111). By analyzing the Sequence Numbers IE of the next STATUS ENQUIRY message transmitted by the UNI "A" CE Side (UNI-C), verify that the <i>Full Status</i> STATUS message with a message type that is not defined was ignored. The send and receive Sequence Numbers of the next STATUS ENQUIRY message transmitted by the UNI "A" CE Side (UNI-C) must be equal to the send and receive Sequence Numbers of the first STATUS ENQUIRY message transmitted by the UNI "A" CE Side (UNI-C)
Units	STATUS ENQUIRY message Sequence Number
Variables	Message Type value
Results	Pass or fail
Remarks	Test Case must be run using T391 in the range (5-30 seconds) and N391 in the range (1-65k). Suggested values for T391 = 5 and N391 = 2

TEST CASE 85C: Missing Mandatory Information Elements

Abstract Test Suite for E-LMI - Impairments	
Test Name	Missing Mandatory Information Elements
Test Definition ID	UNIC-ELMI-5.6.10.4.3-R20
Reference Document	MEF 20 UNI Type 2 Implementation Agreement Section 9 MEF 16 Ethernet Local Management Interface
Test Type	Conformance
Test Status	Mandatory
Requirement Description	When a received STATUS message has one or more missing mandatory Information Elements, the procedure SHALL be restarted and there SHALL not be change in the DI
Test Object	Verify that when a received STATUS message has one or more missing mandatory Information Elements, the procedure is restarted and there is no change in the DI
Test Configuration	Configure UNI "A" CE Side with the default value of N393. Configure UNI "A" MEN Side with the default values of N393 and T392. Tester 1 with proper PHYs that match the UNI "A" MEN side and CE side is monitoring the E-LMI frames
Test Configuration Schematic	<pre> graph LR T2[UNI 'A' MEN Side Tester 2 (Impairment Generator)] --- T1[Monitor Mode Tester 1] T1 --- UCT[UNI 'A' CE Side UNI-C Under Test] </pre>
CE-VLAN ID/EVC Map	Not Specified
Bandwidth Profile	Not Specified
Test Procedure	Restart the UNI "A" CE Side and use the tester 1 to monitor the E-LMI messages for a period of time ($T = 3 \times T391$). Use the tester 2 to respond to the first <i>Full Status</i> STATUS ENQUIRY message sent by he UNI-C by sending a <i>Full Status</i> STATUS message with an incremented DI and a missing Sequence Number Information Element. By analyzing the report type and DI of the next STATUS ENQUIRY message transmitted by the UNI "A" CE Side (UNI-C), verify that the procedure is restarted (report type equal <i>Full Status</i>) and there is no change in the DI.
Units	STATUS ENQUIRY message report type and DI
Variables	None
Results	Pass or fail
Remarks	Test Case must be run using T391 in the range (5-30 seconds) and N391 in the range (1-65k). Suggested values for T391 = 5 and N391 = 2

TEST CASE 86C: Duplicated Information Element

Abstract Test Suite for E-LMI - Impairments	
Test Name	Duplicated Information Element
Test Definition ID	UNIC-ELMI-5.6.10.4.2-R20
Reference Document	MEF 20 UNI Type 2 Implementation Agreement Section 9 MEF 16 Ethernet Local Management Interface
Test Type	Conformance
Test Status	Mandatory
Requirement Description	If an Information Element is duplicated in a message in which repetition is not permitted, only the contents of the first instance of the Information Element SHALL be considered and all subsequent instances SHALL be ignored
Test Object	Verify that if an Information Element is duplicated in a message in which repetition is not permitted, only the contents of the first instance of the Information Element is considered and all subsequent instances are ignored
Test Configuration	Configure UNI "A" CE Side with the default value of N393. Configure UNI "A" MEN Side with the default values of N393 and T392. Tester 1 with proper PHYs that match the UNI "A" MEN side and CE side is monitoring the E-LMI frames
Test Configuration Schematic	<pre> graph LR T2[UNI 'A' MEN Side Tester 2 (Impairment Generator)] --- T1[Monitor Mode Tester 1] T1 --- UT[UNI 'A' CE Side UNI-C Under Test] </pre>
CE-VLAN ID/EVC Map	Not Specified
Bandwidth Profile	Not Specified
Test Procedure	Restart the UNI "A" CE Side and use the tester 1 to monitor the E-LMI messages for a period of time ($T = 3 \times T391$). Use the tester 2 to respond to the first <i>Full Status</i> STATUS ENQUIRY message sent by the UNI-C with a <i>Full Status</i> STATUS message including two protocol version Information Elements; the first instance with a valid content (0000 0001) and the second instance coded other than (0000 0001). Verify that the Report Type of the next STATUS ENQUIRY message transmitted by the UNI "A" CE Side (UNI-C), is ELMI Check confirming that that the full status procedure has not restarted and therefore, that the subsequent instance of the Protocol Version was ignored
Units	STATUS ENQUIRY message Report Type
Variables	None
Results	Pass or fail
Remarks	Test Case must be run using T391 in the range (5-30 seconds) and N391 in the range (1-65k). Suggested values for T391 = 5 and N391 = 2

TEST CASE 87C: Duplicated Sub-Information Element

Abstract Test Suite for E-LMI - Impairments	
Test Name	Duplicated Sub-Information Element
Test Definition ID	UNIC-ELMI-5.6.10.4.2-R20
Reference Document	MEF 20 UNI Type 2 Implementation Agreement Section 9 MEF 16 Ethernet Local Management Interface
Test Type	Conformance
Test Status	Mandatory if access to the UNI-C local database is possible
Requirement Description	If a Sub-information Element in an Information Element is duplicated in a message in which repetition is not permitted, only the contents of the first instance of the Sub-information Element SHALL be considered and all subsequent instances SHALL be ignored
Test Object	Verify that if a Sub-information Element in an Information Element is duplicated in a message in which repetition is not permitted, only the contents of the first instance of the Sub-information Element is considered and all subsequent instances are ignored
Test Configuration	Configure UNI "A" CE Side with the default value of N393. Configure UNI "A" MEN Side with the default values of N393 and T392. Tester 1 with proper PHYs that match the UNI "A" MEN side and CE side is monitoring the E-LMI frames
Test Configuration Schematic	
CE-VLAN ID/EVC Map	Not Specified
Bandwidth Profile	Not Specified
Test Procedure	Restart the UNI "A" CE Side and use the tester 1 to monitor the E-LMI messages for a period of time ($T = 3 \times T391$). Use the tester 2 to respond to the first <i>Full Status</i> STATUS ENQUIRY message sent by the UNI-C with a <i>Full Status</i> STATUS message including two UNI Identifier Sub-information Elements; the first instance with a specific content and the second instance with a different content. If access to the UNI-C local database is possible, verify that the UNI Identifier value is equal to the content of the first instance
Units	UNI-C local database value
Variables	None
Results	Pass or fail
Remarks	Test Case must be run using T391 in the range (5-30 seconds) and N391 in the range (1-65k). Suggested values for T391 = 5 and N391 = 2

TEST CASE 88C: Mandatory Information Element Error

Abstract Test Suite for E-LMI - Impairments																															
Test Name	Mandatory Information Element Error																														
Test Definition ID	UNIC-ELMI-5.6.10.4.4-R20																														
Reference Document	MEF 20 UNI Type 2 Implementation Agreement Section 9 MEF 16 Ethernet Local Management Interface																														
Test Type	Conformance																														
Test Status	Mandatory																														
Requirement Description	When a STATUS message is received and has one or more mandatory Information Elements error, the procedure SHALL be restarted and there SHALL not be change in the DI																														
Test Object	Verify that when a STATUS message is received and has one or more mandatory Information Elements error, the procedure is restarted and there is no change in the DI																														
Test Configuration	At least one EVC is simulated by the tester 2 and at least one CE-VLAN ID is mapped to each EVC A per Ingress UNI bandwidth profile is also simulated at the UNI "A". Configure UNI "A" CE Side with the default value of N393. Configure UNI "A" MEN Side with the default values of N393 and T392. Tester 1 with proper PHYs that match the UNI "A" MEN side and CE side is monitoring the E-LMI frames																														
Test Configuration Schematic	<pre> graph LR T2[UNI 'A' MEN Side Tester 2 (Impairment Generator)] --- T1[Monitor Mode Tester 1] T1 --- U[UNI 'A' CE Side UNI-C Under Test] </pre>																														
CE-VLAN ID/EVC Map	<table border="1" style="margin-left: auto; margin-right: auto;"> <thead> <tr> <th colspan="2" style="text-align: center;">UNI 'A'</th> </tr> <tr> <th style="text-align: center;">CE-VLAN ID</th> <th style="text-align: center;">EVC</th> </tr> </thead> <tbody> <tr> <td style="text-align: center;">11*</td> <td style="text-align: center;">EVC₁</td> </tr> </tbody> </table> <p>Use of other EVCs or CE-VLAN IDs is permitted provided that the configuration of the CE-VLAN ID/EVC Map conforms to MEF 10.1</p> <p>The CE-VLAN ID for untagged and priority tagged Service Frames is configured to 11</p>	UNI 'A'		CE-VLAN ID	EVC	11*	EVC ₁																								
UNI 'A'																															
CE-VLAN ID	EVC																														
11*	EVC ₁																														
Bandwidth Profile	<table border="1" style="margin-left: auto; margin-right: auto;"> <thead> <tr> <th colspan="5" style="text-align: center;">PER INGRESS UNI</th> </tr> <tr> <th style="text-align: center;">UNI</th> <th colspan="4" style="text-align: center;">Bandwidth Profile Parameters</th> </tr> <tr> <th style="text-align: center;">UNI</th> <th style="text-align: center;">CIR</th> <th style="text-align: center;">CBS</th> <th style="text-align: center;">EIR</th> <th style="text-align: center;">EBS</th> </tr> </thead> <tbody> <tr> <td colspan="5">Note 1: (0 < CIR < Ingress UNI Speed), (CBS ≥ maximum Service Frame size)</td> </tr> <tr> <td colspan="5">Note 2: (Ingress CIR ≤ Egress UNI Speed)</td> </tr> <tr> <td colspan="5">Note 3: (EIR ≥ 0) and (EBS ≥ 0)</td> </tr> </tbody> </table>	PER INGRESS UNI					UNI	Bandwidth Profile Parameters				UNI	CIR	CBS	EIR	EBS	Note 1: (0 < CIR < Ingress UNI Speed), (CBS ≥ maximum Service Frame size)					Note 2: (Ingress CIR ≤ Egress UNI Speed)					Note 3: (EIR ≥ 0) and (EBS ≥ 0)				
PER INGRESS UNI																															
UNI	Bandwidth Profile Parameters																														
UNI	CIR	CBS	EIR	EBS																											
Note 1: (0 < CIR < Ingress UNI Speed), (CBS ≥ maximum Service Frame size)																															
Note 2: (Ingress CIR ≤ Egress UNI Speed)																															
Note 3: (EIR ≥ 0) and (EBS ≥ 0)																															
Test Procedure	Restart the UNI "A" CE Side and use the tester 1 to monitor the E-LMI messages for a period of time ($T = 3 \times T391$). Use the tester 2 to respond to the first <i>Full Status</i> STATUS ENQUIRY message send by the UNI-C by sending a <i>Full Status</i> STATUS message with a conflict between the EVC reference IDs in the EVC status IE and in the CE-VLAN ID/EVC map and a specific DI. By analyzing the report type and DI of the next STATUS ENQUIRY message transmitted by the UNI "A" CE Side (UNI-C), verify that, the procedure is restarted and there is no change in the DI																														
Units	STATUS ENQUIRY message report type and DI																														
Variables	None																														
Results	Pass or fail																														
Remarks	Test Case must be run using T391 in the range (5-30 seconds) and N391 in the range (1-65k). Suggested values for T391 = 5 and N391 = 2																														

TEST CASE 89C: Unexpected Recognized Information Element

Abstract Test Suite for E-LMI - Impairments	
Test Name	Unexpected Recognized Information Element
Test Definition ID	UNIC-ELMI-5.6.10.4.5-R20
Reference Document	MEF 20 UNI Type 2 Implementation Agreement Section 9 MEF 16 Ethernet Local Management Interface
Test Type	Conformance
Test Status	Mandatory if access to the UNI-C local database is possible
Requirement Description	When a STATUS message is received with a recognized Information Element not defined to be contained in that message, the UNI-C SHALL treat the Information Element as an unrecognized Information Element and ignore it
Test Object	Verify that when a STATUS message is received with a recognized Information Element not defined to be contained in that message, the UNI-C treats the Information Element as an unrecognized Information Element and ignores it
Test Configuration	Configure UNI "A" CE Side with the default values of N393. Configure UNI "A" MEN Side with the default values of N393 and T392. Tester 1 with proper PHYs that match the UNI "A" MEN side and CE side is monitoring the E-LMI frames
Test Configuration Schematic	<pre> graph LR T2[UNI 'A' MEN Side Tester 2 (Impairment Generator)] --- T1[Monitor Mode Tester 1] T1 --- UCT[UNI 'A' CE Side UNI-C Under Test] </pre>
CE-VLAN ID/EVC Map	Not Specified
Bandwidth Profile	Not Specified
Test Procedure	Restart the UNI "A" CE Side and use the tester 1 to monitor the E-LMI messages for a period of time ($T = 5 \times T391$). Use the tester 2 to respond to an <i>E-LMI Check</i> STATUS ENQUIRY message by sending an <i>E-LMI Check</i> STATUS message including an updated UNI Status Information Element. If access to the UNI-C local database is possible verify that the Information Element was treated as an unrecognized Information Element and was ignored. Therefore, that the database has not been updated following the receipt of the new UNI Status Information Element
Units	UNI-C local database values
Variables	None
Results	Pass or fail
Remarks	Test Case must be run using T391 in the range (5-30 seconds) and N391 in the range (1-65k). Suggested values for T391 = 5 and N391 = 2

TEST CASE 90C: Status Counter Configuration

Abstract Test Suite for E-LMI - Impairments	
Test Name	Status Counter Configuration
Test Definition ID	UNIC-ELMI-5.6.11.1
Reference Document	MEF 20 UNI Type 2 Implementation Agreement Section 9 MEF 16 Ethernet Local Management Interface
Test Type	Conformance
Test Status	Optional. Test only possible if access to the UNI-C local database is possible.
Requirement Description	A UNI-C Type 2 SHOULD allow the configuration of the N393 Status Counter Parameter Threshold in the range from 2 to 10, with the default of 4
Test Object	Verify that a UNI-C Type 2 allows the configuration of the N393 Status Counter Parameter Threshold in the range from 2 to 10, with the default of 4
Test Configuration	Configure UNI "A" MEN Side with the default value of T392. Tester 1 with proper PHYs that match the UNI "A" MEN side and CE side is monitoring the E-LMI frames
Test Configuration Schematic	
CE-VLAN ID/EVC Map	Not Specified
Bandwidth Profile	Not Specified
Test Procedure	Configure the N393 Status Counter Parameter Threshold with a value of 4. Restart the UNI "A" CE Side and use the tester 1 to monitor the E-LMI messages for a period of time ($T = 4 \times T391$). Use the tester 2 to respond to all the STATUS ENQUIRY messages sent by the UNI-C with STATUS messages with a protocol version error (protocol version coded other than 0000 0001). Verify that at this time, the UNI "A" CE Side (UNI-C) reports that the E-LMI is not operational. Repeat the test with (N393 = 2) and ($T = 2 \times T391$). Repeat the test again with the (N393 = 10) and ($T = 10 \times T391$)
Units	N393 Status counter value
Variables	N393
Results	Pass or fail
Remarks	Test Case must be run using T391 in the range (5-30 seconds) and N391 in the range (1-65k). Suggested values for T391 = 5 and N391 = 2

13. Abstract Test Cases for UNI-N Type 2 E-LMI

This section contains a total of 57 Test Cases for UNI-N. It is divided in 4 different subsections as follows:

Section 13.1

E-LMI Framing Mechanism contains a total of 3 Test Cases that covers the requirements described in section 5.2 of MEF 16 Ethernet Local Management Interface and the requirement R18 of UNI Type 2 Implementation Agreement.

Section 13.2

E-LMI Messages contains a total of 25 Test Cases that covers the requirements described in section 5.5 of MEF 16 Ethernet Local Management Interface and the requirement R18 of UNI Type 2 Implementation Agreement.

Section 13.3

E-LMI Procedures contains a total of 19 Test Cases that covers the requirements described in section 5.6 of MEF 16 Ethernet Local Management Interface and the requirements R18, R19 and R22 of UNI Type 2 Implementation Agreement.

Section 13.4

E-LMI Impairments contains a total of 10 Test Cases that covers the requirements described in sections 5.2 to 5.6 of MEF 16 Ethernet Local Management Interface and the requirement R18, R19, R23 and 24 of UNI Type 2 Implementation Agreement.

13.1 E-LMI Framing Mechanism

TEST CASE 1N: E-LMI Frame Destination Address

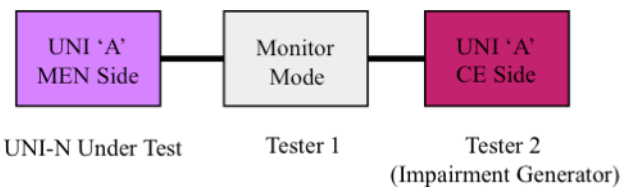
Abstract Test Suite for E-LMI - Framing Mechanisms	
Test Name	E-LMI Frame Destination Address
Test Definition ID	UNIN-ELMI-5.2-R18
Reference Document	MEF 20 UNI Type 2 Implementation Agreement Section 9 MEF 16 Ethernet Local Management Interface
Test Type	Conformance
Test Status	Mandatory
Requirement Description	The E-LMI frame destination addresses SHALL be 01-80-C2-00-00-07
Test Object	Verify that the E-LMI frame destination address is 01-80-C2-00-00-07
Test Configuration	Configure UNI "A" CE Side with the default value of N393. Configure UNI "A" MEN Side with the default values of N393 and T392. Tester 1 with proper PHYs that match the UNI "A" MEN side and CE side is monitoring the E-LMI frames
Test Configuration Schematic	 <pre> graph LR A[UNI 'A' MEN Side] --- B[Monitor Mode] B --- C[UNI 'A' CE Side] subgraph Labels D[UNI-N Under Test] --- E[Tester 1] --- F[Tester 2 (Impairment Generator)] end </pre>
CE-VLAN ID/EVC Map	Not Specified
Bandwidth Profile	Not Specified
Test Procedure	Restart the UNI "A" MEN Side, use the tester 2 to send STATUS ENQUIRY messages and use the tester 1 to monitor the E-LMI messages for a period of time ($T = 3 \times T391$). Verify that the destination address of the STATUS messages sent by the UNI "A" MEN Side (UNI-N) is set to 01-80-C2-00-00-07
Units	Destination address value
Variables	None
Results	Pass or fail
Remarks	Use of the address (01-80-C2-00-00-07) requires that there is no 802.1Q component between UNI-C and UNI-N. Test Case must be run using T391 in the range (5-30 seconds) and N391 in the range (1-65k). Suggested values for T391 = 5 and N391 = 2.

TEST CASE 2N: E-LMI Frame Ethertype

Abstract Test Suite for E-LMI - Framing Mechanisms	
Test Name	E-LMI Frame Ethertype
Test Definition ID	UNIN-ELMI-5.2-R18
Reference Document	MEF 20 UNI Type 2 Implementation Agreement Section 9 MEF 16 Ethernet Local Management Interface
Test Type	Conformance
Test Status	Mandatory
Requirement Description	The E-LMI frame Ethertype SHALL be 88-EE
Test Object	Verify that the E-LMI frame Ethertype is 88-EE
Test Configuration	Configure UNI "A" CE Side with the default value of N393. Configure UNI "A" MEN Side with the default values of N393 and T392. Tester 1 with proper PHYs that match the UNI "A" MEN side and CE side is monitoring the E-LMI frames
Test Configuration Schematic	
CE-VLAN ID/EVC Map	Not Specified
Bandwidth Profile	Not Specified
Test Procedure	Restart the UNI "A" MEN Side, use the tester 2 to send STATUS ENQUIRY messages and use the tester 1 to monitor the E-LMI messages for a period of time ($T = 3 \times T391$). Verify that the Ethertype of the STATUS messages sent by the UNI "A" MEN Side (UNI-N) is set to 88-EE
Units	Ethertype value
Variables	None
Results	Pass or fail
Remarks	Test Case must be run using T391 in the range (5-30 seconds) and N391 in the range (1-65k). Suggested values for T391 = 5 and N391 = 2.

TEST CASE 3N: E-LMI Frame Source Address

Abstract Test Suite for E-LMI - Framing Mechanisms	
Test Name	E-LMI Frame Source Address
Test Definition ID	UNIN-ELMI-5.2-R18
Reference Document	MEF 20 UNI Type 2 Implementation Agreement Section 9 MEF 16 Ethernet Local Management Interface
Test Type	Conformance
Test Status	Mandatory
Requirement Description	The E-LMI frame source address SHALL be the MAC address of the sending station or port
Test Object	Verify that the E-LMI frame source address is the MAC address of the sending station or port
Test Configuration	Configure UNI "A" CE Side with the default value of N393. Configure UNI "A" MEN Side with the default values of N393 and T392. Tester 1 with proper PHYs that match the UNI "A" MEN side and CE side is monitoring the E-LMI frames
Test Configuration Schematic	
CE-VLAN ID/EVC Map	Not Specified
Bandwidth Profile	Not Specified
Test Procedure	Restart the UNI "A" MEN Side, use the tester 2 to send STATUS ENQUIRY messages and use the tester 1 to monitor the E-LMI messages for a period of time ($T = 3 \times T391$). Verify that the source address of the STATUS messages sent by the UNI "A" MEN Side (UNI-N) is the MAC address of the sending station or port
Units	Source address value
Variables	None
Results	Pass or fail
Remarks	Test Case must be run using T391 in the range (5-30 seconds) and N391 in the range (1-65k). Suggested values for T391 = 5 and N391 = 2.

13.2 E-LMI Messages

TEST CASE 4N: General Message Format

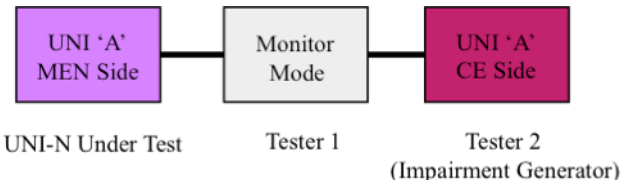
Abstract Test Suite for E-LMI - Messages	
Test Name	General Message Format
Test Definition ID	UNIN-ELMI-5.5.1-R18
Reference Document	MEF 20 UNI Type 2 Implementation Agreement Section 9 MEF 16 Ethernet Local Management Interface
Test Type	Conformance
Test Status	Mandatory
Requirement Description	The following parts of the E-LMI message (Protocol Version, Message Type and Report Type) SHALL always be present
Test Object	Verify that the following parts of the E-LMI message (Protocol Version, Message Type and Report Type) are always present
Test Configuration	Configure UNI "A" CE Side with the default value of N393. Configure UNI "A" MEN Side with the default values of N393 and T392. Tester 1 with proper PHYs that match the UNI "A" MEN side and CE side is monitoring the E-LMI frames
Test Configuration Schematic	 <pre> graph LR A[UNI 'A' MEN Side] --- B[Monitor Mode] --- C[UNI 'A' CE Side] subgraph Labels D[UNI-N Under Test] --- E[Tester 1] --- F[Tester 2 (Impairment Generator)] end </pre>
CE-VLAN ID/EVC Map	Not Specified
Bandwidth Profile	Not Specified
Test Procedure	During all the testing activities, use the tester 2 to send STATUS ENQUIRY messages and use the tester 1 to monitor the E-LMI messages. Verify that each STATUS message transmitted by the UNI "A" MEN side (UNI-N) contains the Protocol Version, Message Type and Report Type parts
Units	Protocol Version, Message Type and Report Type values
Variables	None
Results	Pass or fail
Remarks	Test Case must be run using T391 in the range (5-30 seconds) and N391 in the range (1-65k). Suggested values for T391 = 5 and N391 = 2.

TEST CASE 5N: Order of Appearance of Information Elements

Abstract Test Suite for E-LMI - Messages													
Test Name	Order of Appearance of Information Elements												
Test Definition ID	UNIN-ELMI-5.5.1-R18												
Reference Document	MEF 20 UNI Type 2 Implementation Agreement Section 9 MEF 16 Ethernet Local Management Interface												
Test Type	Conformance												
Test Status	Mandatory												
Requirement Description	When there is more than one Information Element, the order of appearance of the Information Elements SHALL be based on the numerical value of the Information Elements identifiers with Information Elements with lower value identifiers appearing before those with higher value identifiers												
Test Object	Verify that in a message with more than one Information Element, Information Elements with lower value identifiers appear before those with higher value identifiers												
Test Configuration	At least one EVC is configured in the UNI "A" MEN side (UNI-N) with at least one CE-VLAN ID mapped to each EVC. A per Ingress UNI bandwidth profile is applied at the UNI "A". Configure UNI "A" CE Side with the default value of N393. Configure UNI "A" MEN Side with the default values of N393 and T392. Tester 1 with proper PHYs that match the UNI "A" MEN side and CE side is monitoring the E-LMI frames												
Test Configuration Schematic													
CE-VLAN ID/EVC Map	<table border="1" style="width: 100%; border-collapse: collapse;"> <thead> <tr> <th colspan="2" style="text-align: center;">UNI 'A'</th> </tr> <tr> <th style="text-align: center;">CE-VLAN ID</th> <th style="text-align: center;">EVC</th> </tr> </thead> <tbody> <tr> <td style="text-align: center;">11*</td> <td style="text-align: center;">EVC₁</td> </tr> <tr> <td colspan="2">Use of other EVCs or CE-VLAN IDs is permitted provided that the configuration of the CE-VLAN ID/EVC Map conforms to MEF 10.1</td> </tr> <tr> <td colspan="2">The CE-VLAN ID for untagged and priority tagged Service Frames is configured to 11</td> </tr> </tbody> </table>	UNI 'A'		CE-VLAN ID	EVC	11*	EVC ₁	Use of other EVCs or CE-VLAN IDs is permitted provided that the configuration of the CE-VLAN ID/EVC Map conforms to MEF 10.1		The CE-VLAN ID for untagged and priority tagged Service Frames is configured to 11			
UNI 'A'													
CE-VLAN ID	EVC												
11*	EVC ₁												
Use of other EVCs or CE-VLAN IDs is permitted provided that the configuration of the CE-VLAN ID/EVC Map conforms to MEF 10.1													
The CE-VLAN ID for untagged and priority tagged Service Frames is configured to 11													
Bandwidth Profile	<table border="1" style="width: 100%; border-collapse: collapse;"> <thead> <tr> <th colspan="2" style="text-align: center;">PER INGRESS UNI</th> </tr> <tr> <th style="text-align: center;">UNI</th> <th style="text-align: center;">Bandwidth Profile Parameters</th> </tr> </thead> <tbody> <tr> <td style="text-align: center;">UNI</td> <td style="text-align: center;">CIR CBS EIR EBS</td> </tr> <tr> <td colspan="2">Note 1: (0 < CIR < Ingress UNI Speed), (CBS ≥ maximum Service Frame size)</td> </tr> <tr> <td colspan="2">Note 2: (Ingress CIR ≤ Egress UNI Speed)</td> </tr> <tr> <td colspan="2">Note 3: (EIR ≥ 0) and (EBS ≥ 0)</td> </tr> </tbody> </table>	PER INGRESS UNI		UNI	Bandwidth Profile Parameters	UNI	CIR CBS EIR EBS	Note 1: (0 < CIR < Ingress UNI Speed), (CBS ≥ maximum Service Frame size)		Note 2: (Ingress CIR ≤ Egress UNI Speed)		Note 3: (EIR ≥ 0) and (EBS ≥ 0)	
PER INGRESS UNI													
UNI	Bandwidth Profile Parameters												
UNI	CIR CBS EIR EBS												
Note 1: (0 < CIR < Ingress UNI Speed), (CBS ≥ maximum Service Frame size)													
Note 2: (Ingress CIR ≤ Egress UNI Speed)													
Note 3: (EIR ≥ 0) and (EBS ≥ 0)													
Test Procedure	Restart the UNI "A" MEN Side, use the tester 2 to send STATUS ENQUIRY messages and use the tester 1 to monitor the E-LMI messages for a period of time ($T = 3 \times T391$). Verify that in the STATUS messages sent by the UNI "A" MEN Side (UNI-N), the Information Elements with lower value identifiers appear before those with higher value identifiers												
Units	STATUS messages Information Elements identifiers values												
Variables	None												
Results	Pass or fail												
Remarks	Test Case must be run using T391 in the range (5-30 seconds) and N391 in the range (1-65k). Suggested values for T391 = 5 and N391 = 2.												

TEST CASE 6N: Order of Appearance of Sub-Information Elements

Abstract Test Suite for E-LMI - Messages													
Test Name	Order of Appearance of Sub-Information Elements												
Test Definition ID	UNIN-ELMI-5.5.1-R18												
Reference Document	MEF 20 UNI Type 2 Implementation Agreement Section 9 MEF 16 Ethernet Local Management Interface												
Test Type	Conformance												
Test Status	Mandatory												
Requirement Description	When there is more than one Sub-information Element in an Information Element, the order of appearance of the Sub-information Elements SHALL be based on the numerical value of the sub-information identifiers with Sub-information Elements with lower value identifiers appearing before those with higher value identifiers												
Test Object	Verify that in a message with more than one Sub-information Element, Sub-information Elements with lower value identifiers appear before those with higher value identifiers												
Test Configuration	At least one EVC is configured in the UNI "A" MEN Side (UNI-N) with at least one CE-VLAN ID mapped to each EVC. A per Ingress UNI bandwidth profile is applied at the UNI "A". Configure UNI "A" CE Side with the default value of N393. Configure UNI "A" MEN Side with the default values of N393 and T392. Tester 1 with proper PHYs that match the UNI "A" MEN side and CE side is monitoring the E-LMI frames												
Test Configuration Schematic	 <p style="text-align: center;">UNI-N Under Test Tester 1 Tester 2 (Impairment Generator)</p>												
CE-VLAN ID/EVC Map	<table border="1" style="width: 100%; border-collapse: collapse;"> <thead> <tr> <th colspan="2" style="background-color: #f4a460;">UNI 'A'</th> </tr> <tr> <th style="width: 50%;">CE-VLAN ID</th> <th style="width: 50%;">EVC</th> </tr> </thead> <tbody> <tr> <td style="text-align: center;">11*</td> <td style="text-align: center;">EVC₁</td> </tr> <tr> <td colspan="2">Use of other EVCs or CE-VLAN IDs is permitted provided that the configuration of the CE-VLAN ID/EVC Map conforms to MEF 10.1</td> </tr> <tr> <td colspan="2">The CE-VLAN ID for untagged and priority tagged Service Frames is configured to 11</td> </tr> </tbody> </table>	UNI 'A'		CE-VLAN ID	EVC	11*	EVC ₁	Use of other EVCs or CE-VLAN IDs is permitted provided that the configuration of the CE-VLAN ID/EVC Map conforms to MEF 10.1		The CE-VLAN ID for untagged and priority tagged Service Frames is configured to 11			
UNI 'A'													
CE-VLAN ID	EVC												
11*	EVC ₁												
Use of other EVCs or CE-VLAN IDs is permitted provided that the configuration of the CE-VLAN ID/EVC Map conforms to MEF 10.1													
The CE-VLAN ID for untagged and priority tagged Service Frames is configured to 11													
Bandwidth Profile	<table border="1" style="width: 100%; border-collapse: collapse;"> <thead> <tr> <th colspan="2" style="background-color: #f4a460;">PER INGRESS UNI</th> </tr> <tr> <th style="width: 50%;">UNI</th> <th style="width: 50%;">Bandwidth Profile Parameters</th> </tr> </thead> <tbody> <tr> <td style="text-align: center;">UNI</td> <td style="text-align: center;">CIR CBS EIR EBS</td> </tr> <tr> <td colspan="2">Note 1: (0 < CIR < Ingress UNI Speed), (CBS ≥ maximum Service Frame size)</td> </tr> <tr> <td colspan="2">Note 2: (Ingress CIR ≤ Egress UNI Speed)</td> </tr> <tr> <td colspan="2">Note 3: (EIR ≥ 0) and (EBS ≥ 0)</td> </tr> </tbody> </table>	PER INGRESS UNI		UNI	Bandwidth Profile Parameters	UNI	CIR CBS EIR EBS	Note 1: (0 < CIR < Ingress UNI Speed), (CBS ≥ maximum Service Frame size)		Note 2: (Ingress CIR ≤ Egress UNI Speed)		Note 3: (EIR ≥ 0) and (EBS ≥ 0)	
PER INGRESS UNI													
UNI	Bandwidth Profile Parameters												
UNI	CIR CBS EIR EBS												
Note 1: (0 < CIR < Ingress UNI Speed), (CBS ≥ maximum Service Frame size)													
Note 2: (Ingress CIR ≤ Egress UNI Speed)													
Note 3: (EIR ≥ 0) and (EBS ≥ 0)													
Test Procedure	Restart the UNI "A" MEN Side, use the tester 2 to send STATUS ENQUIRY messages and use the tester 1 to monitor the E-LMI messages for a period of time ($T = 3 \times T391$). Verify that in the STATUS messages sent by the UNI "A" MEN Side (UNI-N), the Sub-information Elements with lower value identifiers appear before those with higher value identifiers												
Units	STATUS messages Sub-information Elements identifiers values												
Variables	None												
Results	Pass or fail												
Remarks	Test Case must be run using T391 in the range (5-30 seconds) and N391 in the range (1-65k). Suggested values for T391 = 5 and N391 = 2.												

TEST CASE 7N: Information Elements Reserved Bits

Abstract Test Suite for E-LMI - Messages	
Test Name	Information Elements Reserved Bits
Test Definition ID	UNIN-ELMI-5.5.1-R18
Reference Document	MEF 20 UNI Type 2 Implementation Agreement Section 9 MEF 16 Ethernet Local Management Interface
Test Type	Conformance
Test Status	Mandatory
Requirement Description	When the description of the Information Elements contains reserve bits, these spare bits SHALL be set to "0"
Test Object	Verify that when the description of the Information Elements contains reserve bits, these spare bits are set to "0"
Test Configuration	Configure UNI "A" CE Side with the default value of N393. Configure UNI "A" MEN Side with the default values of N393 and T392. Tester 1 with proper PHYs that match the UNI "A" MEN side and CE side is monitoring the E-LMI frames
Test Configuration Schematic	<pre> graph LR A[UNI 'A' MEN Side] --- B[Monitor Mode] B --- C[UNI 'A' CE Side] subgraph Labels D[UNI-N Under Test] --- A E[Tester 1] --- B F[Tester 2 (Impairment Generator)] --- C end </pre>
CE-VLAN ID/EVC Map	Not Specified
Bandwidth Profile	Not Specified
Test Procedure	Restart the UNI "A" MEN Side, use the tester 2 to send STATUS ENQUIRY messages and use the tester 1 to monitor the E-LMI messages for a period of time ($T = 3 \times T391$). Verify that the reserved bits of the Information Elements of the STATUS messages sent by the UNI "A" MEN Side (UNI-N) are set to "0"
Units	Reserved bits values
Variables	None
Results	Pass or fail
Remarks	Test Case must be run using T391 in the range (5-30 seconds) and N391 in the range (1-65k). Suggested values for T391 = 5 and N391 = 2.

TEST CASE 8N: STATUS message

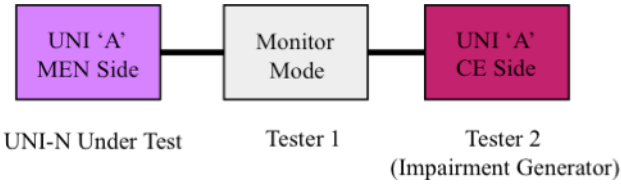
Abstract Test Suite for E-LMI - Messages	
Test Name	STATUS message
Test Definition ID	UNIN-ELMI-5.2-R18 and UNIN-ELMI-5.5.2.1-R18
Reference Document	MEF 20 UNI Type 2 Implementation Agreement Section 9 MEF 16 Ethernet Local Management Interface
Test Type	Conformance
Test Status	Mandatory
Requirement Description	The STATUS message MUST be sent by the UNI-N to the UNI-C in response to a STATUS ENQUIRY message to indicate the status of EVCs or for the exchange of sequence numbers
Test Object	Verify that the STATUS message is sent by the UNI-N to the UNI-C in response to a STATUS ENQUIRY message
Test Configuration	Configure UNI "A" CE Side with the default value of N393. Configure UNI "A" MEN Side with the default values of N393 and T392. Tester 1 with proper PHYs that match the UNI "A" MEN side and CE side is monitoring the E-LMI frames
Test Configuration Schematic	 <pre> graph LR A[UNI 'A' MEN Side] --- B[Monitor Mode] B --- C[UNI 'A' CE Side] A --- A_label[UNI-N Under Test] B --- B_label[Tester 1] C --- C_label[Tester 2 (Impairment Generator)] </pre>
CE-VLAN ID/EVC Map	Not Specified
Bandwidth Profile	Not Specified
Test Procedure	Restart the UNI "A" MEN Side, use the tester 2 to send STATUS ENQUIRY messages and use the tester 1 to monitor the E-LMI messages for a period of time ($T = 3 \times T391$). Verify that a STATUS message is sent by the UNI "A" MEN Side (UNI-N) in response to a STATUS ENQUIRY message
Units	Message Type
Variables	None
Results	Pass or fail
Remarks	Test Case must be run using T391 in the range (5-30 seconds) and N391 in the range (1-65k). Suggested values for T391 = 5 and N391 = 2.

TEST CASE 9N: STATUS Message - Single EVC

Abstract Test Suite for E-LMI - Messages																															
Test Name	STATUS Message - Single EVC																														
Test Definition ID	UNIN-ELMI-5.5.2.1-R18																														
Reference Document	MEF 20 UNI Type 2 Implementation Agreement Section 9 MEF 16 Ethernet Local Management Interface																														
Test Type	Conformance																														
Test Status	Mandatory if <i>Single EVC Asynchronous Status</i> Report Type is supported																														
Requirement Description	The <i>Single EVC Asynchronous Status</i> STATUS message MAY be sent without a STATUS ENQUIRY to indicate the status of a single EVC																														
Test Object	Verify that the <i>Single EVC Asynchronous Status</i> STATUS message is sent by the UNI-N to the UNI-C to indicate the status of a single EVC																														
Test Configuration	At least one EVC associating at least two Type 2 UNIs is configured in the UNI "A" MEN Side (UNI-N) and at least one CE-VLAN ID is mapped to each EVC. A per Ingress UNI bandwidth profile is applied at the UNI "A". Configure UNI "A" CE Side with the default value of N393. Configure UNI "A" MEN Side with the default values of N393 and T392. Tester 1 with proper PHYs that match the UNI "A" MEN side and CE side is monitoring the E-LMI frames																														
Test Configuration Schematic																															
CE-VLAN ID/EVC Map	<table border="1" style="width: 100%; border-collapse: collapse;"> <thead> <tr> <th colspan="2" style="background-color: #f4a460;">UNI 'A'</th> </tr> <tr> <th style="background-color: #f4a460;">CE-VLAN ID</th> <th style="background-color: #f4a460;">EVC</th> </tr> </thead> <tbody> <tr> <td style="background-color: #ffffcc;">11*</td> <td style="background-color: #ffffcc;">EVC₁</td> </tr> </tbody> </table> <p>Use of other EVCs or CE-VLAN IDs is permitted provided that the configuration of the CE-VLAN ID/EVC Map conforms to MEF 10.1</p> <p>The CE-VLAN ID for untagged and priority tagged Service Frames is configured to 11</p>	UNI 'A'		CE-VLAN ID	EVC	11*	EVC ₁																								
UNI 'A'																															
CE-VLAN ID	EVC																														
11*	EVC ₁																														
Bandwidth Profile	<table border="1" style="width: 100%; border-collapse: collapse;"> <thead> <tr> <th colspan="5" style="background-color: #f4a460;">PER INGRESS UNI</th> </tr> <tr> <th style="background-color: #f4a460;">UNI</th> <th colspan="4" style="background-color: #f4a460;">Bandwidth Profile Parameters</th> </tr> <tr> <th style="background-color: #ffffcc;">UNI</th> <th style="background-color: #ffffcc;">CIR</th> <th style="background-color: #ffffcc;">CBS</th> <th style="background-color: #ffffcc;">EIR</th> <th style="background-color: #ffffcc;">EBS</th> </tr> </thead> <tbody> <tr> <td colspan="5">Note 1: (0 < CIR < Ingress UNI Speed), (CBS ≥ maximum Service Frame size)</td> </tr> <tr> <td colspan="5">Note 2: (Ingress CIR ≤ Egress UNI Speed)</td> </tr> <tr> <td colspan="5">Note 3: (EIR ≥ 0) and (EBS ≥ 0)</td> </tr> </tbody> </table>	PER INGRESS UNI					UNI	Bandwidth Profile Parameters				UNI	CIR	CBS	EIR	EBS	Note 1: (0 < CIR < Ingress UNI Speed), (CBS ≥ maximum Service Frame size)					Note 2: (Ingress CIR ≤ Egress UNI Speed)					Note 3: (EIR ≥ 0) and (EBS ≥ 0)				
PER INGRESS UNI																															
UNI	Bandwidth Profile Parameters																														
UNI	CIR	CBS	EIR	EBS																											
Note 1: (0 < CIR < Ingress UNI Speed), (CBS ≥ maximum Service Frame size)																															
Note 2: (Ingress CIR ≤ Egress UNI Speed)																															
Note 3: (EIR ≥ 0) and (EBS ≥ 0)																															
Test Procedure	Restart the UNI "A" MEN Side, use the tester 2 to send STATUS ENQUIRY messages and use the tester 1 to monitor the E-LMI messages for a period of time ($T = 5 \times T391$). After the first Full Status procedure is complete, delete an EVC and verify that a <i>Single EVC Asynchronous Status</i> STATUS message is sent by the UNI "A" MEN Side (UNI-N) to the tester 2																														
Units	Number of <i>Asynchronous Status</i> STATUS message and Report Type																														
Variables	None																														
Results	Pass or fail																														
Remarks	Test Case must be run using T391 in the range (5-30 seconds) and N391 in the range (1-65k). Suggested values for T391 = 5 and N391 = 2.																														

TEST CASE 10N: Structure of the STATUS Message - Sequence Numbers

Abstract Test Suite for E-LMI - Messages																															
Test Name	Structure of the STATUS Message - Sequence Numbers																														
Test Definition ID	UNIN-ELMI-5.5.2.1-R18																														
Reference Document	MEF 20 UNI Type 2 Implementation Agreement Section 9 MEF 16 Ethernet Local Management Interface																														
Test Type	Conformance																														
Test Status	Mandatory																														
Requirement Description	The Sequence Number Information Element is MANDATORY in the STATUS message if the Report Type is <i>Full Status, E-LMI Check</i> or <i>Full Status Continued</i>																														
Test Object	Verify that the Sequence Number Information Element is present in the STATUS message if the Report Type is <i>Full Status, E-LMI Check</i> or <i>Full Status Continued</i>																														
Test Configuration	Multiple EVCs (enough so that the EVC status Information Elements, service attributes and parameters cannot fit into a single <i>Full Status</i> STATUS message) are configured in the UNI "A" MEN Side (UNI-N) and at least one CE-VLAN ID is mapped to each EVC. A per Ingress UNI bandwidth profile is applied at the UNI "A". Configure UNI "A" CE Side with the default value of N393. Configure UNI "A" MEN Side with the default values of N393 and T392. Tester 1 with proper PHYs that match the UNI "A" MEN side and CE side is monitoring the E-LMI frames																														
Test Configuration Schematic																															
CE-VLAN ID/EVC Map	<table border="1" style="width: 100%; border-collapse: collapse;"> <thead> <tr> <th colspan="2" style="text-align: center;">UNI 'A'</th> </tr> <tr> <th style="width: 50%;">CE-VLAN ID</th> <th style="width: 50%;">EVC</th> </tr> </thead> <tbody> <tr> <td style="text-align: center;">11*</td> <td style="text-align: center;">EVC₁</td> </tr> <tr> <td style="text-align: center;">12</td> <td style="text-align: center;">EVC₂</td> </tr> <tr> <td colspan="2">Use of other EVCs or CE-VLAN IDs is permitted provided that the configuration of the CE-VLAN ID/EVC Map conforms to MEF 10.1</td> </tr> <tr> <td colspan="2">The CE-VLAN ID for untagged and priority tagged Service Frames is configured to 11</td> </tr> </tbody> </table>	UNI 'A'		CE-VLAN ID	EVC	11*	EVC ₁	12	EVC ₂	Use of other EVCs or CE-VLAN IDs is permitted provided that the configuration of the CE-VLAN ID/EVC Map conforms to MEF 10.1		The CE-VLAN ID for untagged and priority tagged Service Frames is configured to 11																			
UNI 'A'																															
CE-VLAN ID	EVC																														
11*	EVC ₁																														
12	EVC ₂																														
Use of other EVCs or CE-VLAN IDs is permitted provided that the configuration of the CE-VLAN ID/EVC Map conforms to MEF 10.1																															
The CE-VLAN ID for untagged and priority tagged Service Frames is configured to 11																															
Bandwidth Profile	<table border="1" style="width: 100%; border-collapse: collapse;"> <thead> <tr> <th colspan="5" style="text-align: center;">PER INGRESS UNI</th> </tr> <tr> <th style="width: 50%;">UNI</th> <th colspan="4" style="text-align: center;">Bandwidth Profile Parameters</th> </tr> <tr> <th style="text-align: center;">UNI</th> <th style="text-align: center;">CIR</th> <th style="text-align: center;">CBS</th> <th style="text-align: center;">EIR</th> <th style="text-align: center;">EBS</th> </tr> </thead> <tbody> <tr> <td colspan="5">Note 1: (0 < CIR < Ingress UNI Speed), (CBS ≥ maximum Service Frame size)</td> </tr> <tr> <td colspan="5">Note 2: (Ingress CIR ≤ Egress UNI Speed)</td> </tr> <tr> <td colspan="5">Note 3: (EIR ≥ 0) and (EBS ≥ 0)</td> </tr> </tbody> </table>	PER INGRESS UNI					UNI	Bandwidth Profile Parameters				UNI	CIR	CBS	EIR	EBS	Note 1: (0 < CIR < Ingress UNI Speed), (CBS ≥ maximum Service Frame size)					Note 2: (Ingress CIR ≤ Egress UNI Speed)					Note 3: (EIR ≥ 0) and (EBS ≥ 0)				
PER INGRESS UNI																															
UNI	Bandwidth Profile Parameters																														
UNI	CIR	CBS	EIR	EBS																											
Note 1: (0 < CIR < Ingress UNI Speed), (CBS ≥ maximum Service Frame size)																															
Note 2: (Ingress CIR ≤ Egress UNI Speed)																															
Note 3: (EIR ≥ 0) and (EBS ≥ 0)																															
Test Procedure	Restart the UNI "A" MEN Side, use the tester 2 to send STATUS ENQUIRY messages and use the tester 1 to monitor the E-LMI messages for a period of time ($T = 5 \times T391$). Verify that the Sequence Number Information Element is present in the <i>Full Status, E-LMI Check</i> and <i>Full Status Continued</i> STATUS messages sent by the UNI "A" MEN Side (UNI-N)																														
Units	Sequence Number																														
Variables	None																														
Results	Pass or fail																														
Remarks	Test Case must be run using T391 in the range (5-30 seconds) and N391 in the range (1-65k). Suggested values for T391 = 5 and N391 = 2.																														

TEST CASE 11N: Structure of the STATUS Message - Data Instance (DI)

Abstract Test Suite for E-LMI - Messages																															
Test Name	Structure of the STATUS Message - Data Instance (DI)																														
Test Definition ID	UNIN-ELMI-5.5.2.1-R18																														
Reference Document	MEF 20 UNI Type 2 Implementation Agreement Section 9 MEF 16 Ethernet Local Management Interface																														
Test Type	Conformance																														
Test Status	Mandatory																														
Requirement Description	The Data Instance (DI) Information Element is MANDATORY in the STATUS message if the Report Type is <i>Full Status</i> , <i>E-LMI Check</i> or <i>Full Status Continued</i>																														
Test Object	Verify that the Data Instance (DI) Information Element is present in the STATUS message if the Report Type is <i>Full Status</i> , <i>E-LMI Check</i> or <i>Full Status Continued</i>																														
Test Configuration	Multiple EVCs (enough so that the EVC status Information Elements, service attributes and parameters cannot fit into a single <i>Full Status</i> STATUS message) are configured in the UNI "A" MEN Side (UNI-N) and at least one CE-VLAN ID is mapped to each EVC. A per Ingress UNI bandwidth profile is applied at the UNI "A". Configure UNI "A" CE Side with the default value of N393. Configure UNI "A" MEN Side with the default values of N393 and T392. Tester 1 with proper PHYs that match the UNI "A" MEN side and CE side is monitoring the E-LMI frames																														
Test Configuration Schematic																															
CE-VLAN ID/EVC Map	<table border="1" style="width: 100%; border-collapse: collapse;"> <thead> <tr> <th colspan="2" style="background-color: #f4a460;">UNI "A"</th> </tr> <tr> <th style="background-color: #f4a460;">CE-VLAN ID</th> <th style="background-color: #f4a460;">EVC</th> </tr> </thead> <tbody> <tr> <td style="background-color: #ffffcc;">11*</td> <td style="background-color: #ffffcc;">EVC₁</td> </tr> <tr> <td style="background-color: #ffffcc;">12</td> <td style="background-color: #ffffcc;">EVC₂</td> </tr> <tr> <td colspan="2">Use of other EVCs or CE-VLAN IDs is permitted provided that the configuration of the CE-VLAN ID/EVC Map conforms to MEF 10.1</td> </tr> <tr> <td colspan="2">The CE-VLAN ID for untagged and priority tagged Service Frames is configured to 11</td> </tr> </tbody> </table>	UNI "A"		CE-VLAN ID	EVC	11*	EVC ₁	12	EVC ₂	Use of other EVCs or CE-VLAN IDs is permitted provided that the configuration of the CE-VLAN ID/EVC Map conforms to MEF 10.1		The CE-VLAN ID for untagged and priority tagged Service Frames is configured to 11																			
UNI "A"																															
CE-VLAN ID	EVC																														
11*	EVC ₁																														
12	EVC ₂																														
Use of other EVCs or CE-VLAN IDs is permitted provided that the configuration of the CE-VLAN ID/EVC Map conforms to MEF 10.1																															
The CE-VLAN ID for untagged and priority tagged Service Frames is configured to 11																															
Bandwidth Profile	<table border="1" style="width: 100%; border-collapse: collapse;"> <thead> <tr> <th colspan="5" style="background-color: #f4a460;">PER INGRESS UNI</th> </tr> <tr> <th style="background-color: #f4a460;">UNI</th> <th colspan="4" style="background-color: #f4a460;">Bandwidth Profile Parameters</th> </tr> <tr> <th style="background-color: #ffffcc;">UNI</th> <th style="background-color: #ffffcc;">CIR</th> <th style="background-color: #ffffcc;">CBS</th> <th style="background-color: #ffffcc;">EIR</th> <th style="background-color: #ffffcc;">EBS</th> </tr> </thead> <tbody> <tr> <td colspan="5">Note 1: (0 < CIR < Ingress UNI Speed), (CBS ≥ maximum Service Frame size)</td> </tr> <tr> <td colspan="5">Note 2: (Ingress CIR ≤ Egress UNI Speed)</td> </tr> <tr> <td colspan="5">Note 3: (EIR ≥ 0) and (EBS ≥ 0)</td> </tr> </tbody> </table>	PER INGRESS UNI					UNI	Bandwidth Profile Parameters				UNI	CIR	CBS	EIR	EBS	Note 1: (0 < CIR < Ingress UNI Speed), (CBS ≥ maximum Service Frame size)					Note 2: (Ingress CIR ≤ Egress UNI Speed)					Note 3: (EIR ≥ 0) and (EBS ≥ 0)				
PER INGRESS UNI																															
UNI	Bandwidth Profile Parameters																														
UNI	CIR	CBS	EIR	EBS																											
Note 1: (0 < CIR < Ingress UNI Speed), (CBS ≥ maximum Service Frame size)																															
Note 2: (Ingress CIR ≤ Egress UNI Speed)																															
Note 3: (EIR ≥ 0) and (EBS ≥ 0)																															
Test Procedure	Restart the UNI "A" MEN Side, use the tester 2 to send STATUS ENQUIRY messages and use the tester 1 to monitor the E-LMI messages for a period of time ($T = 5 \times T391$). Verify that the Data Instance Information Element is present in the <i>Full Status</i> , <i>E-LMI Check</i> and <i>Full Status Continued</i> STATUS messages sent by the UNI "A" MEN Side (UNI-N)																														
Units	Data Instance																														
Variables	None																														
Results	Pass or fail																														
Remarks	Test Case must be run using T391 in the range (5-30 seconds) and N391 in the range (1-65k). Suggested values for T391 = 5 and N391 = 2.																														

TEST CASE 12N: Structure of the Full Status STATUS Message - EVC Status

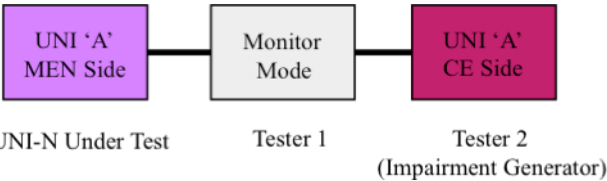
Abstract Test Suite for E-LMI - Messages																															
Test Name	Structure of the <i>Full Status</i> STATUS Message - EVC Status																														
Test Definition ID	UNIN-ELMI-5.5.2.1-R18																														
Reference Document	MEF 20 UNI Type 2 Implementation Agreement Section 9 MEF 16 Ethernet Local Management Interface																														
Test Type	Conformance																														
Test Status	Mandatory																														
Requirement Description	The EVC Status Information Element is MANDATORY in the STATUS message if the report type is <i>Full Status</i> and the UNI has EVCs configured																														
Test Object	Verify that if the UNI has EVCs configured, the EVC Status Information Element is present in the STATUS message if the Report Type is <i>Full Status</i>																														
Test Configuration	At least one EVC associating at least two Type 2 UNIs is configured in the UNI "A" MEN Side (UNI-N) and at least one CE-VLAN ID is mapped to each EVC. A per Ingress UNI bandwidth profile is applied at the UNI "A". Configure UNI "A" CE Side with the default value of N393. Configure UNI "A" MEN Side with the default values of N393 and T392. Tester 1 with proper PHYs that match the UNI "A" MEN side and CE side is monitoring the E-LMI frames																														
Test Configuration Schematic																															
CE-VLAN ID/EVC Map	<table border="1" style="width: 100%; border-collapse: collapse;"> <thead> <tr> <th colspan="2" style="background-color: #f4a460;">UNI 'A'</th> </tr> <tr> <th style="background-color: #f4a460;">CE-VLAN ID</th> <th style="background-color: #f4a460;">EVC</th> </tr> </thead> <tbody> <tr> <td style="background-color: #ffffcc;">11*</td> <td style="background-color: #ffffcc;">EVC₁</td> </tr> <tr> <td colspan="2">Use of other EVCs or CE-VLAN IDs is permitted provided that the configuration of the CE-VLAN ID/EVC Map conforms to MEF 10.1</td> </tr> <tr> <td colspan="2">The CE-VLAN ID for untagged and priority tagged Service Frames is configured to 11</td> </tr> </tbody> </table>	UNI 'A'		CE-VLAN ID	EVC	11*	EVC ₁	Use of other EVCs or CE-VLAN IDs is permitted provided that the configuration of the CE-VLAN ID/EVC Map conforms to MEF 10.1		The CE-VLAN ID for untagged and priority tagged Service Frames is configured to 11																					
UNI 'A'																															
CE-VLAN ID	EVC																														
11*	EVC ₁																														
Use of other EVCs or CE-VLAN IDs is permitted provided that the configuration of the CE-VLAN ID/EVC Map conforms to MEF 10.1																															
The CE-VLAN ID for untagged and priority tagged Service Frames is configured to 11																															
Bandwidth Profile	<table border="1" style="width: 100%; border-collapse: collapse;"> <thead> <tr> <th colspan="5" style="background-color: #f4a460;">PER INGRESS UNI</th> </tr> <tr> <th style="background-color: #f4a460;">UNI</th> <th colspan="4" style="background-color: #f4a460;">Bandwidth Profile Parameters</th> </tr> <tr> <th style="background-color: #f4a460;">UNI</th> <th style="background-color: #ffffcc;">CIR</th> <th style="background-color: #ffffcc;">CBS</th> <th style="background-color: #ffffcc;">EIR</th> <th style="background-color: #ffffcc;">EBS</th> </tr> </thead> <tbody> <tr> <td colspan="5">Note 1: (0 < CIR < Ingress UNI Speed), (CBS ≥ maximum Service Frame size)</td> </tr> <tr> <td colspan="5">Note 2: (Ingress CIR ≤ Egress UNI Speed)</td> </tr> <tr> <td colspan="5">Note 3: (EIR ≥ 0) and (EBS ≥ 0)</td> </tr> </tbody> </table>	PER INGRESS UNI					UNI	Bandwidth Profile Parameters				UNI	CIR	CBS	EIR	EBS	Note 1: (0 < CIR < Ingress UNI Speed), (CBS ≥ maximum Service Frame size)					Note 2: (Ingress CIR ≤ Egress UNI Speed)					Note 3: (EIR ≥ 0) and (EBS ≥ 0)				
PER INGRESS UNI																															
UNI	Bandwidth Profile Parameters																														
UNI	CIR	CBS	EIR	EBS																											
Note 1: (0 < CIR < Ingress UNI Speed), (CBS ≥ maximum Service Frame size)																															
Note 2: (Ingress CIR ≤ Egress UNI Speed)																															
Note 3: (EIR ≥ 0) and (EBS ≥ 0)																															
Test Procedure	Restart the UNI "A" MEN Side, use the tester 2 to send STATUS ENQUIRY messages and use the tester 1 to monitor the E-LMI messages for a period of time ($T = 3 \times T391$). Verify that the EVC Status Information Element is present in the <i>Full Status</i> STATUS messages sent by the UNI "A" MEN Side (UNI-N)																														
Units	EVC Status																														
Variables	None																														
Results	Pass or fail																														
Remarks	Test Case must be run using T391 in the range (5-30 seconds) and N391 in the range (1-65k). Suggested values for T391 = 5 and N391 = 2.																														

TEST CASE 13N: Structure of the *Single EVC Asynchronous Status* STATUS Message - EVC Status

Abstract Test Suite for E-LMI - Messages																															
Test Name	Structure of the <i>Single EVC Asynchronous Status</i> STATUS Message - EVC Status																														
Test Definition ID	UNIN-ELMI-5.5.2.1-R18																														
Reference Document	MEF 20 UNI Type 2 Implementation Agreement Section 9 MEF 16 Ethernet Local Management Interface																														
Test Type	Conformance																														
Test Status	Mandatory if <i>Single EVC Asynchronous Status</i> Report Type if supported																														
Requirement Description	The EVC Status Information Element is MANDATORY in the STATUS message if the report type is <i>Single EVC Asynchronous Status</i> and the UNI has EVCs configured																														
Test Object	Verify that if the UNI has EVCs configured, the EVC Status Information Element is present in the STATUS message if the Report Type is <i>Single EVC Asynchronous Status</i>																														
Test Configuration	At least one EVC associating at least two Type 2 UNIs is configured in the UNI "A" MEN Side (UNI-N) and at least one CE-VLAN ID is mapped to each EVC. A per Ingress UNI bandwidth profile is applied at the UNI "A". Configure UNI "A" CE Side with the default value of N393. Configure UNI "A" MEN Side with the default values of N393 and T392. Tester 1 with proper PHYs that match the UNI "A" MEN side and CE side is monitoring the E-LMI frames																														
Test Configuration Schematic																															
CE-VLAN ID/EVC Map	<table border="1" style="width: 100%; border-collapse: collapse;"> <thead> <tr> <th colspan="2" style="background-color: #f4a460;">UNI 'A'</th> </tr> <tr> <th style="width: 50%;">CE-VLAN ID</th> <th style="width: 50%;">EVC</th> </tr> </thead> <tbody> <tr> <td style="text-align: center;">11*</td> <td style="text-align: center;">EVC₁</td> </tr> </tbody> </table> <p>Use of other EVCs or CE-VLAN IDs is permitted provided that the configuration of the CE-VLAN ID/EVC Map conforms to MEF 10.1</p> <p>The CE-VLAN ID for untagged and priority tagged Service Frames is configured to 11</p>	UNI 'A'		CE-VLAN ID	EVC	11*	EVC ₁																								
UNI 'A'																															
CE-VLAN ID	EVC																														
11*	EVC ₁																														
Bandwidth Profile	<table border="1" style="width: 100%; border-collapse: collapse;"> <thead> <tr> <th colspan="5" style="background-color: #f4a460;">PER INGRESS UNI</th> </tr> <tr> <th style="width: 50%;">UNI</th> <th colspan="4" style="width: 50%;">Bandwidth Profile Parameters</th> </tr> <tr> <th style="background-color: #ffffcc;">UNI</th> <th style="background-color: #ffffcc;">CIR</th> <th style="background-color: #ffffcc;">CBS</th> <th style="background-color: #ffffcc;">EIR</th> <th style="background-color: #ffffcc;">EBS</th> </tr> </thead> <tbody> <tr> <td colspan="5">Note 1: (0 < CIR < Ingress UNI Speed), (CBS ≥ maximum Service Frame size)</td> </tr> <tr> <td colspan="5">Note 2: (Ingress CIR ≤ Egress UNI Speed)</td> </tr> <tr> <td colspan="5">Note 3: (EIR ≥ 0) and (EBS ≥ 0)</td> </tr> </tbody> </table>	PER INGRESS UNI					UNI	Bandwidth Profile Parameters				UNI	CIR	CBS	EIR	EBS	Note 1: (0 < CIR < Ingress UNI Speed), (CBS ≥ maximum Service Frame size)					Note 2: (Ingress CIR ≤ Egress UNI Speed)					Note 3: (EIR ≥ 0) and (EBS ≥ 0)				
PER INGRESS UNI																															
UNI	Bandwidth Profile Parameters																														
UNI	CIR	CBS	EIR	EBS																											
Note 1: (0 < CIR < Ingress UNI Speed), (CBS ≥ maximum Service Frame size)																															
Note 2: (Ingress CIR ≤ Egress UNI Speed)																															
Note 3: (EIR ≥ 0) and (EBS ≥ 0)																															
Test Procedure	Restart the UNI "A" MEN Side, use the tester 2 to send STATUS ENQUIRY messages and use the tester 1 to monitor the E-LMI messages for a period of time ($T = 5 \times T391$). After the first Full Status procedure is complete, delete an EVC and verify that the EVC Status Information Element is present in the STATUS messages sent by the UNI "A" MEN Side (UNI-N) if the Report Type is <i>Single EVC Asynchronous Status</i>																														
Units	EVC Status																														
Variables	None																														
Results	Pass or fail																														
Remarks	Test Case must be run using T391 in the range (5-30 seconds) and N391 in the range (1-65k). Suggested values for T391 = 5 and N391 = 2.																														

TEST CASE 14N: Structure of the STATUS Message - Full Status

Abstract Test Suite for E-LMI - Messages													
Test Name	Structure of the STATUS Message - Full Status												
Test Definition ID	UNIN-ELMI-5.5.2.1-R18												
Reference Document	MEF 20 UNI Type 2 Implementation Agreement Section 9 MEF 16 Ethernet Local Management Interface												
Test Type	Conformance												
Test Status	Mandatory												
Requirement Description	The EVC Status Information Elements SHALL be arranged in the message in ascending order of EVC Reference IDs; the EVC with the lowest EVC Reference ID is first, the second lowest EVC Reference ID is second, and so on												
Test Object	Verify that the EVC Status Information Elements are arranged in the message in ascending order of EVC Reference IDs; the EVC with the lowest EVC Reference ID is first, the second lowest EVC Reference ID is second, and so on												
Test Configuration	At least two EVCs are configured in the UNI "A" MEN Side (UNI-N) and at least one CE-VLAN ID is mapped to each EVC. A per Ingress UNI bandwidth profile is applied at the UNI "A". Configure UNI "A" CE Side with the default value of N393. Configure UNI "A" MEN Side with the default values of N393 and T392. Tester 1 with proper PHYs that match the UNI "A" MEN side and CE side is monitoring the E-LMI frames												
Test Configuration Schematic													
CE-VLAN ID/EVC Map	<table border="1" style="width: 100%; border-collapse: collapse;"> <thead> <tr> <th colspan="2" style="background-color: #f4a460;">UNI 'A'</th> </tr> <tr> <th style="background-color: #f4a460;">CE-VLAN ID</th> <th style="background-color: #f4a460;">EVC</th> </tr> </thead> <tbody> <tr> <td style="background-color: #ffffcc;">11*</td> <td style="background-color: #ffffcc;">EVC₁</td> </tr> <tr> <td style="background-color: #ffffcc;">12</td> <td style="background-color: #ffffcc;">EVC₂</td> </tr> <tr> <td colspan="2">Use of other EVCs or CE-VLAN IDs is permitted provided that the configuration of the CE-VLAN ID/EVC Map conforms to MEF 10.1</td> </tr> <tr> <td colspan="2">The CE-VLAN ID for untagged and priority tagged Service Frames is configured to 11</td> </tr> </tbody> </table>	UNI 'A'		CE-VLAN ID	EVC	11*	EVC ₁	12	EVC ₂	Use of other EVCs or CE-VLAN IDs is permitted provided that the configuration of the CE-VLAN ID/EVC Map conforms to MEF 10.1		The CE-VLAN ID for untagged and priority tagged Service Frames is configured to 11	
UNI 'A'													
CE-VLAN ID	EVC												
11*	EVC ₁												
12	EVC ₂												
Use of other EVCs or CE-VLAN IDs is permitted provided that the configuration of the CE-VLAN ID/EVC Map conforms to MEF 10.1													
The CE-VLAN ID for untagged and priority tagged Service Frames is configured to 11													
Bandwidth Profile	<table border="1" style="width: 100%; border-collapse: collapse;"> <thead> <tr> <th colspan="2" style="background-color: #f4a460;">PER INGRESS UNI</th> </tr> <tr> <th style="background-color: #f4a460;">UNI</th> <th style="background-color: #f4a460;">Bandwidth Profile Parameters</th> </tr> <tr> <th style="background-color: #f4a460;">UNI</th> <th style="background-color: #f4a460;">CIR CBS EIR EBS</th> </tr> </thead> <tbody> <tr> <td colspan="2">Note 1: (0 < CIR < Ingress UNI Speed), (CBS ≥ maximum Service Frame size)</td> </tr> <tr> <td colspan="2">Note 2: (Ingress CIR ≤ Egress UNI Speed)</td> </tr> <tr> <td colspan="2">Note 3: (EIR ≥ 0) and (EBS ≥ 0)</td> </tr> </tbody> </table>	PER INGRESS UNI		UNI	Bandwidth Profile Parameters	UNI	CIR CBS EIR EBS	Note 1: (0 < CIR < Ingress UNI Speed), (CBS ≥ maximum Service Frame size)		Note 2: (Ingress CIR ≤ Egress UNI Speed)		Note 3: (EIR ≥ 0) and (EBS ≥ 0)	
PER INGRESS UNI													
UNI	Bandwidth Profile Parameters												
UNI	CIR CBS EIR EBS												
Note 1: (0 < CIR < Ingress UNI Speed), (CBS ≥ maximum Service Frame size)													
Note 2: (Ingress CIR ≤ Egress UNI Speed)													
Note 3: (EIR ≥ 0) and (EBS ≥ 0)													
Test Procedure	Restart the UNI "A" MEN Side, use the tester 2 to send STATUS ENQUIRY messages and use the tester 1 to monitor the E-LMI messages for a period of time ($T = 3 \times T391$). Verify that the EVC Status Information Elements present in the <i>Full Status</i> STATUS messages sent by the UNI "A" MEN Side (UNI-N) are arranged in ascending order of EVC Reference IDs												
Units	EVC Status Information Elements order												
Variables	None												
Results	Pass or fail												
Remarks	Test Case must be run using T391 in the range (5-30 seconds) and N391 in the range (1-65k). Suggested values for T391 = 5 and N391 = 2.												

TEST CASE 15N: Structure of the STATUS Message - Full Status Continued

Abstract Test Suite for E-LMI - Messages																															
Test Name	Structure of the STATUS Message - Full Status Continued																														
Test Definition ID	UNIN-ELMI-5.5.2.1-R18																														
Reference Document	MEF 20 UNI Type 2 Implementation Agreement Section 9 MEF 16 Ethernet Local Management Interface																														
Test Type	Conformance																														
Test Status	Mandatory																														
Requirement Description	The EVC Status Information Elements SHALL be arranged in the message in ascending order of EVC Reference IDs; the EVC with the lowest EVC Reference ID is first, the second lowest EVC Reference ID is second, and so on and if all Information Elements cannot be sent in a single Ethernet frame, more STATUS messages MUST be sent with Report Type <i>Full Status Continued</i>																														
Test Object	Verify that the EVC Status Information Elements are arranged in the message in ascending order of EVC Reference IDs and that if all Information Elements cannot be sent in a single Ethernet frame, more STATUS messages are sent with Report Type <i>Full Status Continued</i>																														
Test Configuration	Multiple EVCs (so that at least 2 EVC Status Information Elements spill over into the <i>Full Status Continued</i> message) are configured on the UNI "A" MEN Side (UNI-N) and at least one CE-VLAN ID is mapped to each EVC. A per Ingress UNI bandwidth profile is applied at the UNI "A". Configure UNI "A" CE Side with the default value of N393. Configure UNI "A" MEN Side with the default values of N393 and T392. Tester 1 with proper PHYs that match the UNI "A" MEN side and CE side is monitoring the E-LMI frames																														
Test Configuration Schematic																															
CE-VLAN ID/EVC Map	<table border="1" style="width: 100%; border-collapse: collapse;"> <thead> <tr> <th colspan="2" style="text-align: center;">UNI 'A'</th> </tr> <tr> <th style="text-align: center;">CE-VLAN ID</th> <th style="text-align: center;">EVC</th> </tr> </thead> <tbody> <tr> <td style="text-align: center;">11*</td> <td style="text-align: center;">EVC₁</td> </tr> <tr> <td style="text-align: center;">12</td> <td style="text-align: center;">EVC₂</td> </tr> <tr> <td colspan="2">Use of other EVCs or CE-VLAN IDs is permitted provided that the configuration of the CE-VLAN ID/EVC Map conforms to MEF 10.1</td> </tr> <tr> <td colspan="2">The CE-VLAN ID for untagged and priority tagged Service Frames is configured to 11</td> </tr> </tbody> </table>	UNI 'A'		CE-VLAN ID	EVC	11*	EVC ₁	12	EVC ₂	Use of other EVCs or CE-VLAN IDs is permitted provided that the configuration of the CE-VLAN ID/EVC Map conforms to MEF 10.1		The CE-VLAN ID for untagged and priority tagged Service Frames is configured to 11																			
UNI 'A'																															
CE-VLAN ID	EVC																														
11*	EVC ₁																														
12	EVC ₂																														
Use of other EVCs or CE-VLAN IDs is permitted provided that the configuration of the CE-VLAN ID/EVC Map conforms to MEF 10.1																															
The CE-VLAN ID for untagged and priority tagged Service Frames is configured to 11																															
Bandwidth Profile	<table border="1" style="width: 100%; border-collapse: collapse;"> <thead> <tr> <th colspan="5" style="text-align: center;">PER INGRESS UNI</th> </tr> <tr> <th style="text-align: center;">UNI</th> <th colspan="4" style="text-align: center;">Bandwidth Profile Parameters</th> </tr> <tr> <th style="text-align: center;">UNI</th> <th style="text-align: center;">CIR</th> <th style="text-align: center;">CBS</th> <th style="text-align: center;">EIR</th> <th style="text-align: center;">EBS</th> </tr> </thead> <tbody> <tr> <td colspan="5">Note 1: (0 < CIR < Ingress UNI Speed), (CBS ≥ maximum Service Frame size)</td> </tr> <tr> <td colspan="5">Note 2: (Ingress CIR ≤ Egress UNI Speed)</td> </tr> <tr> <td colspan="5">Note 3: (EIR ≥ 0) and (EBS ≥ 0)</td> </tr> </tbody> </table>	PER INGRESS UNI					UNI	Bandwidth Profile Parameters				UNI	CIR	CBS	EIR	EBS	Note 1: (0 < CIR < Ingress UNI Speed), (CBS ≥ maximum Service Frame size)					Note 2: (Ingress CIR ≤ Egress UNI Speed)					Note 3: (EIR ≥ 0) and (EBS ≥ 0)				
PER INGRESS UNI																															
UNI	Bandwidth Profile Parameters																														
UNI	CIR	CBS	EIR	EBS																											
Note 1: (0 < CIR < Ingress UNI Speed), (CBS ≥ maximum Service Frame size)																															
Note 2: (Ingress CIR ≤ Egress UNI Speed)																															
Note 3: (EIR ≥ 0) and (EBS ≥ 0)																															
Test Procedure	Restart the UNI "A" MEN Side, use the tester 2 to send STATUS ENQUIRY messages and use the tester 1 to monitor the E-LMI messages for a period of time ($T = 3 \times T391$). Verify that the EVC Status Information Elements present in the <i>Full Status Continued</i> STATUS messages sent by the UNI "A" MEN Side (UNI-N) are arranged in ascending order of EVC Reference IDs																														
Units	EVC Status Information Elements order																														
Variables	None																														
Results	Pass or fail																														
Remarks	Test Case must be run using T391 in the range (5-30 seconds) and N391 in the range (1-65k). Suggested values for T391 = 5 and N391 = 2.																														

TEST CASE 16N: Structure of the STATUS Message - Asynchronous Status

Abstract Test Suite for E-LMI - Messages																															
Test Name	Structure of the STATUS Message - Asynchronous Status																														
Test Definition ID	UNIN-ELMI-5.5.2.1-R18																														
Reference Document	MEF 20 UNI Type 2 Implementation Agreement Section 9 MEF 16 Ethernet Local Management Interface																														
Test Type	Conformance																														
Test Status	Mandatory if <i>Single EVC Asynchronous Status</i> Report Type is supported																														
Requirement Description	The <i>Single EVC Asynchronous Status</i> STATUS message MUST contain a Single EVC Status Information Element																														
Test Object	Verify that the <i>Single EVC Asynchronous Status</i> STATUS message contains a Single EVC Status Information Element																														
Test Configuration	At least one EVC associating at least two Type 2 UNIs is configured in the UNI "A" MEN Side (UNI-N) and at least one CE-VLAN ID is mapped to each EVC. A per Ingress UNI bandwidth profile is applied at the UNI "A". Configure UNI "A" CE Side with the default value of N393. Configure UNI "A" MEN Side with the default values of N393 and T392. Tester 1 with proper PHYs that match the UNI "A" MEN side and CE side is monitoring the E-LMI frames																														
Test Configuration Schematic																															
CE-VLAN ID/EVC Map	<table border="1" style="width: 100%; border-collapse: collapse;"> <thead> <tr> <th colspan="2" style="background-color: #f4a460;">UNI 'A'</th> </tr> <tr> <th style="width: 50%;">CE-VLAN ID</th> <th style="width: 50%;">EVC</th> </tr> </thead> <tbody> <tr> <td style="text-align: center;">11*</td> <td style="text-align: center;">EVC₁</td> </tr> <tr> <td colspan="2">Use of other EVCs or CE-VLAN IDs is permitted provided that the configuration of the CE-VLAN ID/EVC Map conforms to MEF 10.1</td> </tr> <tr> <td colspan="2">The CE-VLAN ID for untagged and priority tagged Service Frames is configured to 11</td> </tr> </tbody> </table>	UNI 'A'		CE-VLAN ID	EVC	11*	EVC ₁	Use of other EVCs or CE-VLAN IDs is permitted provided that the configuration of the CE-VLAN ID/EVC Map conforms to MEF 10.1		The CE-VLAN ID for untagged and priority tagged Service Frames is configured to 11																					
UNI 'A'																															
CE-VLAN ID	EVC																														
11*	EVC ₁																														
Use of other EVCs or CE-VLAN IDs is permitted provided that the configuration of the CE-VLAN ID/EVC Map conforms to MEF 10.1																															
The CE-VLAN ID for untagged and priority tagged Service Frames is configured to 11																															
Bandwidth Profile	<table border="1" style="width: 100%; border-collapse: collapse;"> <thead> <tr> <th colspan="5" style="background-color: #f4a460;">PER INGRESS UNI</th> </tr> <tr> <th style="width: 50%;">UNI</th> <th colspan="4" style="width: 50%;">Bandwidth Profile Parameters</th> </tr> <tr> <th style="text-align: center;">UNI</th> <th style="text-align: center;">CIR</th> <th style="text-align: center;">CBS</th> <th style="text-align: center;">EIR</th> <th style="text-align: center;">EBS</th> </tr> </thead> <tbody> <tr> <td colspan="5">Note 1: (0 < CIR < Ingress UNI Speed), (CBS ≥ maximum Service Frame size)</td> </tr> <tr> <td colspan="5">Note 2: (Ingress CIR ≤ Egress UNI Speed)</td> </tr> <tr> <td colspan="5">Note 3: (EIR ≥ 0) and (EBS ≥ 0)</td> </tr> </tbody> </table>	PER INGRESS UNI					UNI	Bandwidth Profile Parameters				UNI	CIR	CBS	EIR	EBS	Note 1: (0 < CIR < Ingress UNI Speed), (CBS ≥ maximum Service Frame size)					Note 2: (Ingress CIR ≤ Egress UNI Speed)					Note 3: (EIR ≥ 0) and (EBS ≥ 0)				
PER INGRESS UNI																															
UNI	Bandwidth Profile Parameters																														
UNI	CIR	CBS	EIR	EBS																											
Note 1: (0 < CIR < Ingress UNI Speed), (CBS ≥ maximum Service Frame size)																															
Note 2: (Ingress CIR ≤ Egress UNI Speed)																															
Note 3: (EIR ≥ 0) and (EBS ≥ 0)																															
Test Procedure	Restart the UNI "A" MEN Side, use the tester 2 to send STATUS ENQUIRY messages and use the tester 1 to monitor the E-LMI messages for a period of time ($T = 5 \times T391$). After the first Full Status procedure is complete, delete an EVC and verify that the <i>Single EVC Asynchronous Status</i> STATUS message sent by the UNI "A" MEN Side (UNI-N) contains a Single EVC Status Information Element																														
Units	Number of EVC Status Information Elements																														
Variables	None																														
Results	Pass or fail																														
Remarks	Test Case must be run using T391 in the range (5-30 seconds) and N391 in the range (1-65k). Suggested values for T391 = 5 and N391 = 2.																														

TEST CASE 17N: EVC Status and CE-VLAN ID/EVC Map Information Elements

Abstract Test Suite for E-LMI - Messages																															
Test Name	EVC Status and CE-VLAN ID/EVC Map Information Elements																														
Test Definition ID	UNIN-ELMI-5.5.2.1-R18																														
Reference Document	MEF 20 UNI Type 2 Implementation Agreement Section 9 MEF 16 Ethernet Local Management Interface																														
Test Type	Conformance																														
Test Status	Mandatory																														
Requirement Description	The EVC Status Information Element MUST precede the CE-VLAN ID/EVC Map Information Element																														
Test Object	Verify that the EVC Status Information Element precedes the CE-VLAN ID/EVC Map Information Element																														
Test Configuration	At least one EVC is configured in the UNI "A" MEN Side (UNI-N) and at least one CE-VLAN ID is mapped to each EVC. A per Ingress UNI bandwidth profile is applied at the UNI "A". Configure UNI "A" CE Side with the default value of N393. Configure UNI "A" MEN Side with the default values of N393 and T392. Tester 1 with proper PHYs that match the UNI "A" MEN side and CE side is monitoring the E-LMI frames																														
Test Configuration Schematic																															
CE-VLAN ID/EVC Map	<table border="1" style="width: 100%; border-collapse: collapse;"> <thead> <tr> <th colspan="2" style="background-color: #f4a460;">UNI 'A'</th> </tr> <tr> <th style="width: 50%;">CE-VLAN ID</th> <th style="width: 50%;">EVC</th> </tr> </thead> <tbody> <tr> <td style="text-align: center;">11*</td> <td style="text-align: center;">EVC₁</td> </tr> <tr> <td colspan="2">Use of other EVCs or CE-VLAN IDs is permitted provided that the configuration of the CE-VLAN ID/EVC Map conforms to MEF 10.1</td> </tr> <tr> <td colspan="2">The CE-VLAN ID for untagged and priority tagged Service Frames is configured to 11</td> </tr> </tbody> </table>	UNI 'A'		CE-VLAN ID	EVC	11*	EVC ₁	Use of other EVCs or CE-VLAN IDs is permitted provided that the configuration of the CE-VLAN ID/EVC Map conforms to MEF 10.1		The CE-VLAN ID for untagged and priority tagged Service Frames is configured to 11																					
UNI 'A'																															
CE-VLAN ID	EVC																														
11*	EVC ₁																														
Use of other EVCs or CE-VLAN IDs is permitted provided that the configuration of the CE-VLAN ID/EVC Map conforms to MEF 10.1																															
The CE-VLAN ID for untagged and priority tagged Service Frames is configured to 11																															
Bandwidth Profile	<table border="1" style="width: 100%; border-collapse: collapse;"> <thead> <tr> <th colspan="5" style="background-color: #f4a460;">PER INGRESS UNI</th> </tr> <tr> <th style="width: 50%;">UNI</th> <th colspan="4" style="width: 50%;">Bandwidth Profile Parameters</th> </tr> <tr> <th style="text-align: center;">UNI</th> <th style="text-align: center;">CIR</th> <th style="text-align: center;">CBS</th> <th style="text-align: center;">EIR</th> <th style="text-align: center;">EBS</th> </tr> </thead> <tbody> <tr> <td colspan="5">Note 1: (0 < CIR < Ingress UNI Speed), (CBS ≥ maximum Service Frame size)</td> </tr> <tr> <td colspan="5">Note 2: (Ingress CIR ≤ Egress UNI Speed)</td> </tr> <tr> <td colspan="5">Note 3: (EIR ≥ 0) and (EBS ≥ 0)</td> </tr> </tbody> </table>	PER INGRESS UNI					UNI	Bandwidth Profile Parameters				UNI	CIR	CBS	EIR	EBS	Note 1: (0 < CIR < Ingress UNI Speed), (CBS ≥ maximum Service Frame size)					Note 2: (Ingress CIR ≤ Egress UNI Speed)					Note 3: (EIR ≥ 0) and (EBS ≥ 0)				
PER INGRESS UNI																															
UNI	Bandwidth Profile Parameters																														
UNI	CIR	CBS	EIR	EBS																											
Note 1: (0 < CIR < Ingress UNI Speed), (CBS ≥ maximum Service Frame size)																															
Note 2: (Ingress CIR ≤ Egress UNI Speed)																															
Note 3: (EIR ≥ 0) and (EBS ≥ 0)																															
Test Procedure	Restart the UNI "A" MEN Side, use the tester 2 to send STATUS ENQUIRY messages and use the tester 1 to monitor the E-LMI messages for a period of time ($T = 3 \times T391$). Verify that the EVC Status Information Element precedes the CE-VLAN ID/EVC Map Information Element in the <i>Full Status</i> STATUS messages sent by the UNI "A" MEN Side (UNI-N)																														
Units	EVC Status Information Element and CE-VLAN ID/EVC Information Element order																														
Variables	None																														
Results	Pass or fail																														
Remarks	Test Case must be run using T391 in the range (5-30 seconds) and N391 in the range (1-65k). Suggested values for T391 = 5 and N391 = 2.																														

TEST CASE 18N: Protocol Version

Abstract Test Suite for E-LMI - Messages	
Test Name	Protocol Version
Test Definition ID	UNIN-ELMI-5.5.3.1-R18
Reference Document	MEF 20 UNI Type 2 Implementation Agreement Section 9 MEF 16 Ethernet Local Management Interface
Test Type	Conformance
Test Status	Mandatory
Requirement Description	The Protocol Version field SHALL contain the value (00000001) to claim compliance with Version 1 of this protocol
Test Object	Verify that the Protocol Version field contains the value (00000001) to claim compliance with Version 1 of this protocol
Test Configuration	Configure UNI "A" CE Side with the default value of N393. Configure UNI "A" MEN Side with the default values of N393 and T392. Tester 1 with proper PHYs that match the UNI "A" MEN side and CE side is monitoring the E-LMI frames
Test Configuration Schematic	
CE-VLAN ID/EVC Map	Not Specified
Bandwidth Profile	Not Specified
Test Procedure	Restart the UNI "A" MEN Side, use the tester 2 to send STATUS ENQUIRY messages and use the tester 1 to monitor the E-LMI messages for a period of time ($T = 3 \times T391$). Verify that the Protocol Version field of the STATUS messages sent by the UNI "A" MEN Side (UNI-N) contains the value (00000001)
Units	Protocol Version value
Variables	None
Results	Pass or fail
Remarks	Test Case must be run using T391 in the range (5-30 seconds) and N391 in the range (1-65k). Suggested values for T391 = 5 and N391 = 2.

TEST CASE 19N: CE-VLAN ID/EVC Map IE - Default EVC Bit set to “0”

Abstract Test Suite for E-LMI - Messages																															
Test Name	CE-VLAN ID/EVC Map IE - Default EVC Bit set to “0”																														
Test Definition ID	UNIN-ELMI-5.5.3.5-R18																														
Reference Document	MEF 20 UNI Type 2 Implementation Agreement Section 9 MEF 16 Ethernet Local Management Interface																														
Test Type	Conformance																														
Test Status	Mandatory																														
Requirement Description	The Default EVC bit has significance only if CE-VLAN ID/EVC Map Type is equal to Bundling. It MUST be set to 0 when it is not significant																														
Test Object	Verify that the Default EVC bit is set to 0 if CE-VLAN ID/EVC Map Type is not equal to Bundling																														
Test Configuration	At least one EVC is configured in the UNI “A” MEN Side (UNI-N) and one CE-VLAN ID is mapped to each EVC. A per Ingress UNI bandwidth profile is applied at the UNI “A”. Configure UNI “A” CE Side with the default value of N393. Configure UNI “A” MEN Side with the default values of N393 and T392. Tester 1 with proper PHYs that match the UNI “A” MEN side and CE side is monitoring the E-LMI frames																														
Test Configuration Schematic																															
CE-VLAN ID/EVC Map	<table border="1" style="width: 100%; border-collapse: collapse;"> <thead> <tr> <th colspan="2" style="text-align: center;">UNI ‘A’</th> </tr> <tr> <th style="width: 50%;">CE-VLAN ID</th> <th style="width: 50%;">EVC</th> </tr> </thead> <tbody> <tr> <td style="text-align: center;">11*</td> <td style="text-align: center;">EVC₁</td> </tr> <tr> <td colspan="2">Use of other EVCs or CE-VLAN IDs is permitted provided that the configuration of the CE-VLAN ID/EVC Map conforms to MEF 10.1</td> </tr> <tr> <td colspan="2">The CE-VLAN ID for untagged and priority tagged Service Frames is configured to 11</td> </tr> </tbody> </table>	UNI ‘A’		CE-VLAN ID	EVC	11*	EVC ₁	Use of other EVCs or CE-VLAN IDs is permitted provided that the configuration of the CE-VLAN ID/EVC Map conforms to MEF 10.1		The CE-VLAN ID for untagged and priority tagged Service Frames is configured to 11																					
UNI ‘A’																															
CE-VLAN ID	EVC																														
11*	EVC ₁																														
Use of other EVCs or CE-VLAN IDs is permitted provided that the configuration of the CE-VLAN ID/EVC Map conforms to MEF 10.1																															
The CE-VLAN ID for untagged and priority tagged Service Frames is configured to 11																															
Bandwidth Profile	<table border="1" style="width: 100%; border-collapse: collapse;"> <thead> <tr> <th colspan="5" style="text-align: center;">PER INGRESS UNI</th> </tr> <tr> <th style="width: 50%;">UNI</th> <th colspan="4" style="text-align: center;">Bandwidth Profile Parameters</th> </tr> <tr> <th style="text-align: center;">UNI</th> <th style="text-align: center;">CIR</th> <th style="text-align: center;">CBS</th> <th style="text-align: center;">EIR</th> <th style="text-align: center;">EBS</th> </tr> </thead> <tbody> <tr> <td colspan="5">Note 1: (0 < CIR < Ingress UNI Speed), (CBS ≥ maximum Service Frame size)</td> </tr> <tr> <td colspan="5">Note 2: (Ingress CIR ≤ Egress UNI Speed)</td> </tr> <tr> <td colspan="5">Note 3: (EIR ≥ 0) and (EBS ≥ 0)</td> </tr> </tbody> </table>	PER INGRESS UNI					UNI	Bandwidth Profile Parameters				UNI	CIR	CBS	EIR	EBS	Note 1: (0 < CIR < Ingress UNI Speed), (CBS ≥ maximum Service Frame size)					Note 2: (Ingress CIR ≤ Egress UNI Speed)					Note 3: (EIR ≥ 0) and (EBS ≥ 0)				
PER INGRESS UNI																															
UNI	Bandwidth Profile Parameters																														
UNI	CIR	CBS	EIR	EBS																											
Note 1: (0 < CIR < Ingress UNI Speed), (CBS ≥ maximum Service Frame size)																															
Note 2: (Ingress CIR ≤ Egress UNI Speed)																															
Note 3: (EIR ≥ 0) and (EBS ≥ 0)																															
Test Procedure	Restart the UNI “A” MEN Side, use the tester 2 to send STATUS ENQUIRY messages and use the tester 1 to monitor the E-LMI messages for a period of time ($T = 3 \times T391$). Verify that the Default EVC bits of the CE-VLAN ID/EVC Map Information Elements of the <i>Full Status</i> STATUS messages sent by the UNI “A” MEN Side (UNI-N) are set to 0 since the CE-VLAN ID/EVC Map Types are not equal to Bundling																														
Units	Default EVC bit value																														
Variables	None																														
Results	Pass or fail																														
Remarks	Test Case must be run using T391 in the range (5-30 seconds) and N391 in the range (1-65k). Suggested values for T391 = 5 and N391 = 2.																														

TEST CASE 20N: CE-VLAN ID/EVC Map IE - Sequence Number

Abstract Test Suite for E-LMI - Messages																										
Test Name	CE-VLAN ID/EVC Map IE - Sequence Number																									
Test Definition ID	UNIN-ELMI-5.5.3.5-R18																									
Reference Document	MEF 20 UNI Type 2 Implementation Agreement Section 9 MEF 16 Ethernet Local Management Interface																									
Test Type	Conformance																									
Test Status	Mandatory if 64 EVCs and more are supported at the UNI																									
Requirement Description	If the CE-VLAN ID/EVC Map sequence number exceeds 6 bits counter, it MUST roll over to zero																									
Test Object	Verify that if the CE-VLAN ID/EVC Map sequence number exceeds 6 bits counter, it rolls over to zero																									
Test Configuration	At least 64 EVCs (enough so that the CE-VLAN ID/EVC Map sequence numbers will exceed 6 bits counter) are configured on the UNI "A" MEN Side (UNI-N) and at least one CE-VLAN ID is mapped to each EVC. A per Ingress UNI bandwidth profile is applied at the UNI "A". Configure UNI "A" CE Side with the default value of N393. Configure UNI "A" MEN Side with the default values of N393 and T392. Tester 1 with proper PHYs that match the UNI "A" MEN side and CE side is monitoring the E-LMI frames																									
Test Configuration Schematic																										
CE-VLAN ID/EVC Map	<table border="1" style="width: 100%; border-collapse: collapse;"> <thead> <tr> <th colspan="2" style="text-align: center;">UNI 'A'</th> </tr> <tr> <th style="text-align: center;">CE-VLAN ID</th> <th style="text-align: center;">EVC</th> </tr> </thead> <tbody> <tr> <td style="text-align: center;">11*</td> <td style="text-align: center;">EVC₁</td> </tr> <tr> <td style="text-align: center;">12</td> <td style="text-align: center;">EVC₂</td> </tr> <tr> <td style="text-align: center;">...</td> <td style="text-align: center;">...</td> </tr> <tr> <td style="text-align: center;">64</td> <td style="text-align: center;">EVC₆₄</td> </tr> </tbody> </table> <p>Use of other EVCs or CE-VLAN IDs is permitted provided that the configuration of the CE-VLAN ID/EVC Map conforms to MEF 10.1</p> <p>The CE-VLAN ID for untagged and priority tagged Service Frames is configured to 11</p>	UNI 'A'		CE-VLAN ID	EVC	11*	EVC ₁	12	EVC ₂	64	EVC ₆₄													
UNI 'A'																										
CE-VLAN ID	EVC																									
11*	EVC ₁																									
12	EVC ₂																									
...	...																									
64	EVC ₆₄																									
Bandwidth Profile	<table border="1" style="width: 100%; border-collapse: collapse;"> <thead> <tr> <th colspan="4" style="text-align: center;">PER INGRESS UNI</th> </tr> <tr> <th style="text-align: center;">UNI</th> <th colspan="3" style="text-align: center;">Bandwidth Profile Parameters</th> </tr> <tr> <th style="text-align: center;">UNI</th> <th style="text-align: center;">CIR</th> <th style="text-align: center;">CBS</th> <th style="text-align: center;">EIR</th> <th style="text-align: center;">EBS</th> </tr> </thead> <tbody> <tr> <td colspan="4">Note 1: (0 < CIR < Ingress UNI Speed), (CBS ≥ maximum Service Frame size)</td> </tr> <tr> <td colspan="4">Note 2: (Ingress CIR ≤ Egress UNI Speed)</td> </tr> <tr> <td colspan="4">Note 3: (EIR ≥ 0) and (EBS ≥ 0)</td> </tr> </tbody> </table>	PER INGRESS UNI				UNI	Bandwidth Profile Parameters			UNI	CIR	CBS	EIR	EBS	Note 1: (0 < CIR < Ingress UNI Speed), (CBS ≥ maximum Service Frame size)				Note 2: (Ingress CIR ≤ Egress UNI Speed)				Note 3: (EIR ≥ 0) and (EBS ≥ 0)			
PER INGRESS UNI																										
UNI	Bandwidth Profile Parameters																									
UNI	CIR	CBS	EIR	EBS																						
Note 1: (0 < CIR < Ingress UNI Speed), (CBS ≥ maximum Service Frame size)																										
Note 2: (Ingress CIR ≤ Egress UNI Speed)																										
Note 3: (EIR ≥ 0) and (EBS ≥ 0)																										
Test Procedure	Restart the UNI "A" MEN Side, use the tester 2 to send STATUS ENQUIRY messages and use the tester 1 to monitor the E-LMI messages for a period of time ($T = 5 \times T391$). Verify that when the CE-VLAN ID/EVC Map sequence number exceeds 6 bits counter, it rolls over to zero																									
Units	CE-VLAN ID/EVC Map Sequence Number value																									
Variables	None																									
Results	Pass or fail																									
Remarks	Test Case must be run using T391 in the range (5-30 seconds) and N391 in the range (1-65k). Suggested values for T391 = 5 and N391 = 2.																									

TEST CASE 21N: EVC Status IE - Full Status & Full Status Continued

Abstract Test Suite for E-LMI - Messages																															
Test Name	EVC Status IE - <i>Full Status & Full Status Continued</i>																														
Test Definition ID	UNIN-ELMI-5.5.3.7-R18																														
Reference Document	MEF 20 UNI Type 2 Implementation Agreement Section 9 MEF 16 Ethernet Local Management Interface																														
Test Type	Conformance																														
Test Status	Mandatory																														
Requirement Description	The EVC Status Information Element of a <i>Full Status</i> or a <i>Full Status Continued</i> Report Type MUST contain EVC Parameters, EVC Identifiers and Bandwidth Profile Sub-information Elements																														
Test Object	Verify that the EVC Status Information Element of a <i>Full Status</i> or a <i>Full Status Continued</i> Report Type contains EVC Parameters, EVC Identifiers and Bandwidth Profile Sub-information Elements																														
Test Configuration	Multiple EVCs (enough so that the EVC status Information Elements, service attributes and parameters cannot fit into a single <i>Full Status</i> STATUS message) are configured on the UNI "A" MEN Side (UNI-N) and at least one CE-VLAN ID is mapped to each EVC. A per Ingress UNI bandwidth profile is applied at the UNI "A". Configure UNI "A" CE Side with the default value of N393. Configure UNI "A" MEN Side with the default values of N393 and T392. Tester 1 with proper PHYs that match the UNI "A" MEN side and CE side is monitoring the E-LMI frames																														
Test Configuration Schematic																															
CE-VLAN ID/EVC Map	<table border="1" style="width: 100%; border-collapse: collapse;"> <thead> <tr> <th colspan="2" style="background-color: #f4a460;">UNI "A"</th> </tr> <tr> <th style="background-color: #f4a460;">CE-VLAN ID</th> <th style="background-color: #f4a460;">EVC</th> </tr> </thead> <tbody> <tr> <td style="background-color: #ffffcc;">11*</td> <td style="background-color: #ffffcc;">EVC₁</td> </tr> <tr> <td style="background-color: #ffffcc;">12</td> <td style="background-color: #ffffcc;">EVC₂</td> </tr> </tbody> </table> <p>Use of other EVCs or CE-VLAN IDs is permitted provided that the configuration of the CE-VLAN ID/EVC Map conforms to MEF 10.1</p> <p>The CE-VLAN ID for untagged and priority tagged Service Frames is configured to 11</p>	UNI "A"		CE-VLAN ID	EVC	11*	EVC ₁	12	EVC ₂																						
UNI "A"																															
CE-VLAN ID	EVC																														
11*	EVC ₁																														
12	EVC ₂																														
Bandwidth Profile	<table border="1" style="width: 100%; border-collapse: collapse;"> <thead> <tr> <th colspan="5" style="background-color: #f4a460;">PER INGRESS UNI</th> </tr> <tr> <th style="background-color: #f4a460;">UNI</th> <th colspan="4" style="background-color: #f4a460;">Bandwidth Profile Parameters</th> </tr> <tr> <th style="background-color: #ffffcc;">UNI</th> <th style="background-color: #ffffcc;">CIR</th> <th style="background-color: #ffffcc;">CBS</th> <th style="background-color: #ffffcc;">EIR</th> <th style="background-color: #ffffcc;">EBS</th> </tr> </thead> <tbody> <tr> <td colspan="5">Note 1: (0 < CIR < Ingress UNI Speed), (CBS ≥ maximum Service Frame size)</td> </tr> <tr> <td colspan="5">Note 2: (Ingress CIR ≤ Egress UNI Speed)</td> </tr> <tr> <td colspan="5">Note 3: (EIR ≥ 0) and (EBS ≥ 0)</td> </tr> </tbody> </table>	PER INGRESS UNI					UNI	Bandwidth Profile Parameters				UNI	CIR	CBS	EIR	EBS	Note 1: (0 < CIR < Ingress UNI Speed), (CBS ≥ maximum Service Frame size)					Note 2: (Ingress CIR ≤ Egress UNI Speed)					Note 3: (EIR ≥ 0) and (EBS ≥ 0)				
PER INGRESS UNI																															
UNI	Bandwidth Profile Parameters																														
UNI	CIR	CBS	EIR	EBS																											
Note 1: (0 < CIR < Ingress UNI Speed), (CBS ≥ maximum Service Frame size)																															
Note 2: (Ingress CIR ≤ Egress UNI Speed)																															
Note 3: (EIR ≥ 0) and (EBS ≥ 0)																															
Test Procedure	Restart the UNI "A" MEN Side, use the tester 2 to send STATUS ENQUIRY messages and use the tester 1 to monitor the E-LMI messages for a period of time ($T = 5 \times T391$). Verify that the EVC Status Information Elements present in the <i>Full Status</i> and <i>Full Status Continued</i> STATUS messages sent by the UNI "A" MEN Side (UNI-N) contain EVC Parameters, EVC Identifiers and Bandwidth Profile Sub-information Elements																														
Units	EVC Status Information Elements value																														
Variables	None																														
Results	Pass or fail																														
Remarks	Test Case must be run using T391 in the range (5-30 seconds) and N391 in the range (1-65k). Suggested values for T391 = 5 and N391 = 2.																														

TEST CASE 22N: EVC Status IE - Single EVC Asynchronous Status

Abstract Test Suite for E-LMI - Messages																															
Test Name	EVC Status IE - Single EVC Asynchronous Status																														
Test Definition ID	UNIN-ELMI-5.5.3.7-R18																														
Reference Document	MEF 20 UNI Type 2 Implementation Agreement Section 9 MEF 16 Ethernet Local Management Interface																														
Test Type	Conformance																														
Test Status	Mandatory if <i>Single EVC Asynchronous Status</i> Report Type is supported																														
Requirement Description	The EVC Status Information Element of a <i>Single EVC Asynchronous Status</i> Report Type MUST NOT contain EVC Parameters, EVC Identifiers or Bandwidth Profile Sub-information Elements																														
Test Object	Verify that the EVC Status Information Element of a <i>Single EVC Asynchronous Status</i> Report Type does not contain EVC Parameters, EVC Identifiers and Bandwidth Profile Sub-information Elements																														
Test Configuration	At least one EVC associating at least two Type 2 UNIs is configured on the UNI "A" MEN Side (UNI-N) and at least one CE-VLAN ID is mapped to each EVC. A per Ingress UNI bandwidth profile is applied at the UNI "A". Configure UNI "A" CE Side with the default value of N393. Configure UNI "A" MEN Side with the default values of N393 and T392. Tester 1 with proper PHYs that match the UNI "A" MEN side and CE side is monitoring the E-LMI frames																														
Test Configuration Schematic																															
CE-VLAN ID/EVC Map	<table border="1" style="width: 100%; border-collapse: collapse;"> <thead> <tr> <th colspan="2" style="background-color: #f4a460;">UNI 'A'</th> </tr> <tr> <th style="width: 50%;">CE-VLAN ID</th> <th style="width: 50%;">EVC</th> </tr> </thead> <tbody> <tr> <td style="text-align: center;">11*</td> <td style="text-align: center;">EVC₁</td> </tr> <tr> <td colspan="2">Use of other EVCs or CE-VLAN IDs is permitted provided that the configuration of the CE-VLAN ID/EVC Map conforms to MEF 10.1</td> </tr> <tr> <td colspan="2">The CE-VLAN ID for untagged and priority tagged Service Frames is configured to 11</td> </tr> </tbody> </table>	UNI 'A'		CE-VLAN ID	EVC	11*	EVC ₁	Use of other EVCs or CE-VLAN IDs is permitted provided that the configuration of the CE-VLAN ID/EVC Map conforms to MEF 10.1		The CE-VLAN ID for untagged and priority tagged Service Frames is configured to 11																					
UNI 'A'																															
CE-VLAN ID	EVC																														
11*	EVC ₁																														
Use of other EVCs or CE-VLAN IDs is permitted provided that the configuration of the CE-VLAN ID/EVC Map conforms to MEF 10.1																															
The CE-VLAN ID for untagged and priority tagged Service Frames is configured to 11																															
Bandwidth Profile	<table border="1" style="width: 100%; border-collapse: collapse;"> <thead> <tr> <th colspan="5" style="background-color: #f4a460;">PER INGRESS UNI</th> </tr> <tr> <th style="width: 50%;">UNI</th> <th colspan="4" style="width: 50%;">Bandwidth Profile Parameters</th> </tr> <tr> <th style="text-align: center;">UNI</th> <th style="text-align: center;">CIR</th> <th style="text-align: center;">CBS</th> <th style="text-align: center;">EIR</th> <th style="text-align: center;">EBS</th> </tr> </thead> <tbody> <tr> <td colspan="5">Note 1: (0 < CIR < Ingress UNI Speed), (CBS ≥ maximum Service Frame size)</td> </tr> <tr> <td colspan="5">Note 2: (Ingress CIR ≤ Egress UNI Speed)</td> </tr> <tr> <td colspan="5">Note 3: (EIR ≥ 0) and (EBS ≥ 0)</td> </tr> </tbody> </table>	PER INGRESS UNI					UNI	Bandwidth Profile Parameters				UNI	CIR	CBS	EIR	EBS	Note 1: (0 < CIR < Ingress UNI Speed), (CBS ≥ maximum Service Frame size)					Note 2: (Ingress CIR ≤ Egress UNI Speed)					Note 3: (EIR ≥ 0) and (EBS ≥ 0)				
PER INGRESS UNI																															
UNI	Bandwidth Profile Parameters																														
UNI	CIR	CBS	EIR	EBS																											
Note 1: (0 < CIR < Ingress UNI Speed), (CBS ≥ maximum Service Frame size)																															
Note 2: (Ingress CIR ≤ Egress UNI Speed)																															
Note 3: (EIR ≥ 0) and (EBS ≥ 0)																															
Test Procedure	Restart the UNI "A" MEN Side, use the tester 2 to send STATUS ENQUIRY messages and use the tester 1 to monitor the E-LMI messages for a period of time ($T = 5 \times T391$). After the first Full Status procedure is complete, delete an EVC and verify that the <i>Single EVC Asynchronous Status</i> STATUS message sent by the UNI "A" MEN Side (UNI-N) does not contain EVC Parameters, EVC Identifiers or Bandwidth Profile Sub-information Elements																														
Units	EVC Status Information Elements value																														
Variables	None																														
Results	Pass or fail																														
Remarks	Test Case must be run using T391 in the range (5-30 seconds) and N391 in the range (1-65k). Suggested values for T391 = 5 and N391 = 2.																														

TEST CASE 23N: Data Instance IE - Reserved Value

Abstract Test Suite for E-LMI - Messages	
Test Name	Data Instance IE - Reserved Value
Test Definition ID	UNIN-ELMI-5.5.3.8-R18
Reference Document	MEF 20 UNI Type 2 Implementation Agreement Section 9 MEF 16 Ethernet Local Management Interface
Test Type	Conformance
Test Status	Mandatory
Requirement Description	The Data Instance value of “0x00000000” MUST never be sent by the UNI-N
Test Object	Verify that the Data Instance value of “0x00000000” is never be sent by the UNI-N
Test Configuration	Configure UNI “A” CE Side with the default value of N393. Configure UNI “A” MEN Side with the default values of N393 and T392. Tester 1 with proper PHYs that match the UNI “A” MEN side and CE side is monitoring the E-LMI frames
Test Configuration Schematic	<pre> graph LR A[UNI 'A' MEN Side] --- B[Monitor Mode] B --- C[UNI 'A' CE Side] A --- A_label[UNI-N Under Test] B --- B_label[Tester 1] C --- C_label[Tester 2 (Impairment Generator)] </pre>
CE-VLAN ID/EVC Map	Not Specified
Bandwidth Profile	Not Specified
Test Procedure	During all the testing activities, use the tester 2 to send STATUS ENQUIRY messages and use the tester 1 monitor the E-LMI messages. Verify that the Data Instance value of the STATUS messages transmitted by the UNI “A” MEN side (UNI-N) is never set to “0x00000000”
Units	Data Instance value
Variables	None
Results	Pass or fail
Remarks	Test Case must be run using T391 in the range (5-30 seconds) and N391 in the range (1-65k). Suggested values for T391 = 5 and N391 = 2.

TEST CASE 24N: EVC Map Entry Sub-Information Element

Abstract Test Suite for E-LMI - Messages																															
Test Name	EVC Map Entry Sub-Information Element																														
Test Definition ID	UNIN-ELMI-5.5.3.10-R18																														
Reference Document	MEF 20 UNI Type 2 Implementation Agreement Section 9 MEF 16 Ethernet Local Management Interface																														
Test Type	Conformance																														
Test Status	Mandatory																														
Requirement Description	At least one CE-VLAN ID (with a value of 1, 2, ..., 4095) MUST be present in an EVC Map Entry Sub-information Element. More than one CE-VLAN ID MAY be present																														
Test Object	Verify that at least one CE-VLAN ID (with a value of 1, 2, ..., 4095) is present in an EVC Map Entry Sub-information Element																														
Test Configuration	At least one EVC is configured on the UNI "A" MEN Side (UNI-N) and at least one CE-VLAN ID is mapped to each EVC. A per Ingress UNI bandwidth profile is applied at the UNI "A". Configure UNI "A" CE Side with the default value of N393. Configure UNI "A" MEN Side with the default values of N393 and T392. Tester 1 with proper PHYs that match the UNI "A" MEN side and CE side is monitoring the E-LMI frames																														
Test Configuration Schematic																															
CE-VLAN ID/EVC Map	<table border="1" style="width: 100%; border-collapse: collapse;"> <thead> <tr> <th colspan="2" style="text-align: center;">UNI 'A'</th> </tr> <tr> <th style="width: 50%;">CE-VLAN ID</th> <th style="width: 50%;">EVC</th> </tr> </thead> <tbody> <tr> <td style="text-align: center;">11*</td> <td style="text-align: center;">EVC₁</td> </tr> <tr> <td colspan="2">Use of other EVCs or CE-VLAN IDs is permitted provided that the configuration of the CE-VLAN ID/EVC Map conforms to MEF 10.1</td> </tr> <tr> <td colspan="2">The CE-VLAN ID for untagged and priority tagged Service Frames is configured to 11</td> </tr> </tbody> </table>	UNI 'A'		CE-VLAN ID	EVC	11*	EVC ₁	Use of other EVCs or CE-VLAN IDs is permitted provided that the configuration of the CE-VLAN ID/EVC Map conforms to MEF 10.1		The CE-VLAN ID for untagged and priority tagged Service Frames is configured to 11																					
UNI 'A'																															
CE-VLAN ID	EVC																														
11*	EVC ₁																														
Use of other EVCs or CE-VLAN IDs is permitted provided that the configuration of the CE-VLAN ID/EVC Map conforms to MEF 10.1																															
The CE-VLAN ID for untagged and priority tagged Service Frames is configured to 11																															
Bandwidth Profile	<table border="1" style="width: 100%; border-collapse: collapse;"> <thead> <tr> <th colspan="5" style="text-align: center;">PER INGRESS UNI</th> </tr> <tr> <th style="width: 50%;">UNI</th> <th colspan="4" style="text-align: center;">Bandwidth Profile Parameters</th> </tr> <tr> <th style="text-align: center;">UNI</th> <th style="text-align: center;">CIR</th> <th style="text-align: center;">CBS</th> <th style="text-align: center;">EIR</th> <th style="text-align: center;">EBS</th> </tr> </thead> <tbody> <tr> <td colspan="5">Note 1: (0 < CIR < Ingress UNI Speed), (CBS ≥ maximum Service Frame size)</td> </tr> <tr> <td colspan="5">Note 2: (Ingress CIR ≤ Egress UNI Speed)</td> </tr> <tr> <td colspan="5">Note 3: (EIR ≥ 0) and (EBS ≥ 0)</td> </tr> </tbody> </table>	PER INGRESS UNI					UNI	Bandwidth Profile Parameters				UNI	CIR	CBS	EIR	EBS	Note 1: (0 < CIR < Ingress UNI Speed), (CBS ≥ maximum Service Frame size)					Note 2: (Ingress CIR ≤ Egress UNI Speed)					Note 3: (EIR ≥ 0) and (EBS ≥ 0)				
PER INGRESS UNI																															
UNI	Bandwidth Profile Parameters																														
UNI	CIR	CBS	EIR	EBS																											
Note 1: (0 < CIR < Ingress UNI Speed), (CBS ≥ maximum Service Frame size)																															
Note 2: (Ingress CIR ≤ Egress UNI Speed)																															
Note 3: (EIR ≥ 0) and (EBS ≥ 0)																															
Test Procedure	Restart the UNI "A" MEN Side, use the tester 2 to send STATUS ENQUIRY messages and use the tester 1 to monitor the E-LMI messages for a period of time ($T = 3 \times T391$). Verify that at least one CE-VLAN ID (with a value of 1, 2, ..., 4095) is present in the EVC Map Entry Sub-information Element of the <i>Full Status</i> STATUS messages sent by the UNI "A" MEN Side (UNI-N)																														
Units	EVC Map Entry Sub-information Element value																														
Variables	None																														
Results	Pass or fail																														
Remarks	Test Case must be run using T391 in the range (5-30 seconds) and N391 in the range (1-65k). Suggested values for T391 = 5 and N391 = 2.																														

TEST CASE 25N: UNI Identifier Sub-Information Element - Undefined UNI Identifier

Abstract Test Suite for E-LMI - Messages	
Test Name	UNI Identifier Sub-Information Element - Undefined UNI Identifier
Test Definition ID	UNIN-ELMI-5.5.3.11-R18
Reference Document	MEF 20 UNI Type 2 Implementation Agreement Section 9 MEF 16 Ethernet Local Management Interface
Test Type	Conformance
Test Status	Mandatory
Requirement Description	When no UNI Identifier is defined, the UNI-N SHALL set the contents of the IE to 0x00 (ASCII null)
Test Object	Verify that when no UNI Identifier is defined, the UNI-N sets the contents of the IE to 0x00 (ASCII null)
Test Configuration	Configure UNI "A" MEN Side (UNI-N) without UNI Identifier. Configure UNI "A" CE Side with the default value of N393. Configure UNI "A" MEN Side with the default values of N393 and T392. Tester 1 with proper PHYs that match the UNI "A" MEN side and CE side is monitoring the E-LMI frames
Test Configuration Schematic	<pre> graph LR A[UNI 'A' MEN Side] --- B[Monitor Mode] B --- C[UNI 'A' CE Side] subgraph Labels A --- A_label[UNI-N Under Test] B --- B_label[Tester 1] C --- C_label[Tester 2 (Impairment Generator)] end </pre>
CE-VLAN ID/EVC Map	Not Specified
Bandwidth Profile	Not Specified
Test Procedure	Restart the UNI "A" MEN Side, use the tester 2 to send STATUS ENQUIRY messages and use the tester 1 to monitor the E-LMI messages for a period of time ($T = 3 \times T391$). Verify that the content of the UNI Identifier Sub-information Element of the <i>Full Status</i> STATUS messages sent by the UNI "A" MEN Side (UNI-N) is set to 0x00
Units	UNI Identifier Sub-information Element value
Variables	None
Results	Pass or fail
Remarks	Test Case must be run using T391 in the range (5-30 seconds) and N391 in the range (1-65k). Suggested values for T391 = 5 and N391 = 2.

TEST CASE 26N: UNI Identifier Sub-Information Element - Defined UNI Identifier

Abstract Test Suite for E-LMI - Messages	
Test Name	UNI Identifier Sub-Information Element - Defined UNI Identifier
Test Definition ID	UNIN-ELMI-5.5.3.11-R18
Reference Document	MEF 20 UNI Type 2 Implementation Agreement Section 9 MEF 16 Ethernet Local Management Interface
Test Type	Conformance
Test Status	Mandatory
Requirement Description	When the actual value of the UNI Identifier is greater than 64 ASCII octets, the UNI Identifier Sub-information Element SHALL contain the first 64 ASCII octets of the actual value
Test Object	Verify that when the actual value of the UNI Identifier is greater than 64 ASCII octets, the UNI Identifier Sub-information Element contains the first 64 ASCII octets of the actual value
Test Configuration	Configure UNI "A" MEN Side (UNI-N) with a UNI Identifier greater than 64 ASCII octets. Configure UNI "A" CE Side with the default value of N393. Configure UNI "A" MEN Side with the default values of N393 and T392. Tester 1 with proper PHYs that match the UNI "A" MEN side and CE side is monitoring the E-LMI frames
Test Configuration Schematic	
CE-VLAN ID/EVC Map	Not Specified
Bandwidth Profile	Not Specified
Test Procedure	Restart the UNI "A" MEN Side, use the tester 2 to send STATUS ENQUIRY messages and use the tester 1 to monitor the E-LMI messages for a period of time ($T = 3 \times T391$). Verify that the UNI Identifier Sub-information Element of the <i>Full Status</i> STATUS messages sent by the UNI "A" MEN Side (UNI-N) contains the first 64 ASCII octets of the actual value
Units	UNI Identifier Sub-information Element value
Variables	None
Results	Pass or fail
Remarks	Test Case must be run using T391 in the range (5-30 seconds) and N391 in the range (1-65k). Suggested values for T391 = 5 and N391 = 2.

TEST CASE 27N: EVC Identifier Sub-Information Element - Undefined EVC Identifier

Abstract Test Suite for E-LMI - Messages																															
Test Name	EVC Identifier Sub-Information Element - Undefined EVC Identifier																														
Test Definition ID	UNIN-ELMI-5.5.3.12-R18																														
Reference Document	MEF 20 UNI Type 2 Implementation Agreement Section 9 MEF 16 Ethernet Local Management Interface																														
Test Type	Conformance																														
Test Status	Mandatory																														
Requirement Description	When no EVC Identifier is defined, the UNI-N SHALL set the contents of the IE to 0x00 (ASCII null)																														
Test Object	Verify that when no EVC Identifier is defined, the UNI-N set the contents of the IE to 0x00 (ASCII null)																														
Test Configuration	At least one EVC without EVC Identifier is configured on the UNI "A" MEN Side (UNI-N) and at least one CE-VLAN ID is mapped to each EVC. A per Ingress UNI bandwidth profile is applied at the UNI "A". Configure UNI "A" CE Side with the default value of N393. Configure UNI "A" MEN Side with the default values of N393 and T392. Tester 1 with proper PHYs that match the UNI "A" MEN side and CE side is monitoring the E-LMI frames																														
Test Configuration Schematic																															
CE-VLAN ID/EVC Map	<table border="1" style="width: 100%; border-collapse: collapse;"> <thead> <tr> <th colspan="2" style="text-align: center;">UNI 'A'</th> </tr> <tr> <th style="text-align: center;">CE-VLAN ID</th> <th style="text-align: center;">EVC</th> </tr> </thead> <tbody> <tr> <td style="text-align: center;">11*</td> <td style="text-align: center;">EVC₁</td> </tr> </tbody> </table> <p>Use of other EVCs or CE-VLAN IDs is permitted provided that the configuration of the CE-VLAN ID/EVC Map conforms to MEF 10.1</p> <p>The CE-VLAN ID for untagged and priority tagged Service Frames is configured to 11</p>	UNI 'A'		CE-VLAN ID	EVC	11*	EVC ₁																								
UNI 'A'																															
CE-VLAN ID	EVC																														
11*	EVC ₁																														
Bandwidth Profile	<table border="1" style="width: 100%; border-collapse: collapse;"> <thead> <tr> <th colspan="5" style="text-align: center;">PER INGRESS UNI</th> </tr> <tr> <th style="text-align: center;">UNI</th> <th colspan="4" style="text-align: center;">Bandwidth Profile Parameters</th> </tr> <tr> <th style="text-align: center;">UNI</th> <th style="text-align: center;">CIR</th> <th style="text-align: center;">CBS</th> <th style="text-align: center;">EIR</th> <th style="text-align: center;">EBS</th> </tr> </thead> <tbody> <tr> <td colspan="5">Note 1: (0 < CIR < Ingress UNI Speed), (CBS ≥ maximum Service Frame size)</td> </tr> <tr> <td colspan="5">Note 2: (Ingress CIR ≤ Egress UNI Speed)</td> </tr> <tr> <td colspan="5">Note 3: (EIR ≥ 0) and (EBS ≥ 0)</td> </tr> </tbody> </table>	PER INGRESS UNI					UNI	Bandwidth Profile Parameters				UNI	CIR	CBS	EIR	EBS	Note 1: (0 < CIR < Ingress UNI Speed), (CBS ≥ maximum Service Frame size)					Note 2: (Ingress CIR ≤ Egress UNI Speed)					Note 3: (EIR ≥ 0) and (EBS ≥ 0)				
PER INGRESS UNI																															
UNI	Bandwidth Profile Parameters																														
UNI	CIR	CBS	EIR	EBS																											
Note 1: (0 < CIR < Ingress UNI Speed), (CBS ≥ maximum Service Frame size)																															
Note 2: (Ingress CIR ≤ Egress UNI Speed)																															
Note 3: (EIR ≥ 0) and (EBS ≥ 0)																															
Test Procedure	Restart the UNI "A" MEN Side, use the tester 2 to send STATUS ENQUIRY messages and use the tester 1 to monitor the E-LMI messages for a period of time ($T = 3 \times T391$). Verify that the content of the EVC Identifier Sub-information Element related to the EVC configured without EVC Identifier of the <i>Full Status</i> STATUS messages sent by the UNI "A" MEN Side (UNI-N) is set to 0x00																														
Units	EVC Identifier Sub-information Element value																														
Variables	None																														
Results	Pass or fail																														
Remarks	Test Case must be run using T391 in the range (5-30 seconds) and N391 in the range (1-65k). Suggested values for T391 = 5 and N391 = 2.																														

TEST CASE 28N: EVC Identifier Sub-Information Element - Defined EVC Identifier

Abstract Test Suite for E-LMI - Messages																															
Test Name	EVC Identifier Sub-Information Element - Defined EVC Identifier																														
Test Definition ID	UNIN-ELMI-5.5.3.12-R18																														
Reference Document	MEF 20 UNI Type 2 Implementation Agreement Section 9 MEF 16 Ethernet Local Management Interface																														
Test Type	Conformance																														
Test Status	Mandatory																														
Requirement Description	When the actual value of the EVC Identifier is greater than 100 ASCII octets, the EVC Identifier Sub-information Element SHALL contain the first 100 ASCII octets of the actual value																														
Test Object	Verify that when the actual value of the EVC Identifier is greater than 100 ASCII octets, the EVC Identifier Sub-information Element contains the first 100 ASCII octets of the actual value																														
Test Configuration	At least one EVC with an EVC Identifier greater than 100 ASCII octets is configured on the UNI "A" MEN Side (UNI-N) and at least one CE-VLAN ID is mapped to each EVC. A per Ingress UNI bandwidth profile is applied at the UNI "A". Configure UNI "A" CE Side with the default value of N393. Configure UNI "A" MEN Side with the default values of N393 and T392. Tester 1 with proper PHYs that match the UNI "A" MEN side and CE side is monitoring the E-LMI frames																														
Test Configuration Schematic																															
CE-VLAN ID/EVC Map	<table border="1" style="width: 100%; border-collapse: collapse;"> <thead> <tr> <th colspan="2" style="text-align: center;">UNI 'A'</th> </tr> <tr> <th style="text-align: center;">CE-VLAN ID</th> <th style="text-align: center;">EVC</th> </tr> </thead> <tbody> <tr> <td style="text-align: center;">11*</td> <td style="text-align: center;">EVC₁</td> </tr> </tbody> </table> <p>Use of other EVCs or CE-VLAN IDs is permitted provided that the configuration of the CE-VLAN ID/EVC Map conforms to MEF 10.1</p> <p>The CE-VLAN ID for untagged and priority tagged Service Frames is configured to 11</p>	UNI 'A'		CE-VLAN ID	EVC	11*	EVC ₁																								
UNI 'A'																															
CE-VLAN ID	EVC																														
11*	EVC ₁																														
Bandwidth Profile	<table border="1" style="width: 100%; border-collapse: collapse;"> <thead> <tr> <th colspan="5" style="text-align: center;">PER INGRESS UNI</th> </tr> <tr> <th style="text-align: center;">UNI</th> <th colspan="4" style="text-align: center;">Bandwidth Profile Parameters</th> </tr> <tr> <th style="text-align: center;">UNI</th> <th style="text-align: center;">CIR</th> <th style="text-align: center;">CBS</th> <th style="text-align: center;">EIR</th> <th style="text-align: center;">EBS</th> </tr> </thead> <tbody> <tr> <td colspan="5">Note 1: (0 < CIR < Ingress UNI Speed), (CBS ≥ maximum Service Frame size)</td> </tr> <tr> <td colspan="5">Note 2: (Ingress CIR ≤ Egress UNI Speed)</td> </tr> <tr> <td colspan="5">Note 3: (EIR ≥ 0) and (EBS ≥ 0)</td> </tr> </tbody> </table>	PER INGRESS UNI					UNI	Bandwidth Profile Parameters				UNI	CIR	CBS	EIR	EBS	Note 1: (0 < CIR < Ingress UNI Speed), (CBS ≥ maximum Service Frame size)					Note 2: (Ingress CIR ≤ Egress UNI Speed)					Note 3: (EIR ≥ 0) and (EBS ≥ 0)				
PER INGRESS UNI																															
UNI	Bandwidth Profile Parameters																														
UNI	CIR	CBS	EIR	EBS																											
Note 1: (0 < CIR < Ingress UNI Speed), (CBS ≥ maximum Service Frame size)																															
Note 2: (Ingress CIR ≤ Egress UNI Speed)																															
Note 3: (EIR ≥ 0) and (EBS ≥ 0)																															
Test Procedure	Restart the UNI "A" MEN Side, use the tester 2 to send STATUS ENQUIRY messages and use the tester 1 to monitor the E-LMI messages for a period of time ($T = 3 \times T391$). Verify that the EVC Identifier Sub-information Element related to the EVC configured with an EVC Identifier greater than 100 ASCII octets of the <i>Full Status</i> STATUS messages sent by the UNI "A" MEN Side (UNI-N) contains the first 64 ASCII octets of the actual value																														
Units	EVC Identifier Sub-information Element value																														
Variables	None																														
Results	Pass or fail																														
Remarks	Test Case must be run using T391 in the range (5-30 seconds) and N391 in the range (1-65k). Suggested values for T391 = 5 and N391 = 2.																														

13.3 E-LMI Procedures

TEST CASE 29N: STATUS ENQUIRY Message

Abstract Test Suite for E-LMI - Procedures	
Test Name	Status Enquiry Message
Test Definition ID	UNIN-ELMI-5.6.2-R18
Reference Document	MEF 20 UNI Type 2 Implementation Agreement Section 9 MEF 16 Ethernet Local Management Interface
Test Type	Conformance
Test Status	Mandatory
Requirement Description	The STATUS ENQUIRY message SHALL only be sent by the UNI-C
Test Object	Verify that the STATUS ENQUIRY message is never sent by the UNI-N
Test Configuration	Configure UNI "A" CE Side with the default value of N393. Configure UNI "A" MEN Side with the default values of N393 and T392. Tester 1 with proper PHYs that match the UNI "A" MEN side and CE side is monitoring the E-LMI frames
Test Configuration Schematic	<pre> graph LR A[UNI 'A' MEN Side] --- B[Monitor Mode] B --- C[UNI 'A' CE Side] subgraph Labels D[UNI-N Under Test] --- A E[Tester 1] --- B F[Tester 2 (Impairment Generator)] --- C end </pre>
CE-VLAN ID/EVC Map	Not Specified
Bandwidth Profile	Not Specified
Test Procedure	During all the testing activities, use the tester 2 to send STATUS ENQUIRY messages and use the tester 1 monitor the E-LMI messages. Verify that STATUS ENQUIRY messages are never sent by the UNI "A" MEN Side (UNI-N)
Units	STATUS ENQUIRY messages Source address
Variables	None
Results	Pass or fail
Remarks	Test Case must be run using T391 in the range (5-30 seconds) and N391 in the range (1-65k). Suggested values for T391 = 5 and N391 = 2.

TEST CASE 32N: UNI-N Response to a STATUS ENQUIRY Requesting Full Status

Abstract Test Suite for E-LMI - Procedures	
Test Name	UNI-N Response to a STATUS ENQUIRY Requesting Full Status
Test Definition ID	UNIN-ELMI-5.6.2-R18
Reference Document	MEF 20 UNI Type 2 Implementation Agreement Section 9 MEF 16 Ethernet Local Management Interface
Test Type	Conformance
Test Status	Mandatory
Requirement Description	If the UNI-C sends a STATUS ENQUIRY requesting full status, the UNI-N MUST respond with a STATUS message with the Report Type specifying <i>Full Status</i>
Test Object	Verify that when the UNI-C sends a STATUS ENQUIRY requesting full status, the UNI-N responds with a STATUS message with the Report Type specifying <i>Full Status</i>
Test Configuration	Configure UNI "A" CE Side with the default value of N393. Configure UNI "A" MEN Side with the default values of N393 and T392. Tester 1 with proper PHYs that match the UNI "A" MEN side and CE side is monitoring the E-LMI frames
Test Configuration Schematic	
CE-VLAN ID/EVC Map	Not Specified
Bandwidth Profile	Not Specified
Test Procedure	Restart the UNI "A" MEN Side, use the tester 2 to send STATUS ENQUIRY messages and use the tester 1 to monitor the E-LMI messages for a period of time ($T = 3 \times T391$). Verify that when the UNI "A" CE Side sends a STATUS ENQUIRY requesting full status, the UNI "A" MEN Side (UNI-N) responds with a <i>Full Status</i> STATUS message
Units	STATUS message Report Type
Variables	None
Results	Pass or fail
Remarks	Test Case must be run using T391 in the range (5-30 seconds) and N391 in the range (1-65k). Suggested values for T391 = 5 and N391 = 2.

TEST CASE 33N: UNI-N *Full Status* STATUS Message - EVC Status IE

Abstract Test Suite for E-LMI - Procedures																										
Test Name	UNI-N <i>Full Status</i> STATUS Message - EVC Status IE																									
Test Definition ID	UNIN-ELMI-5.6.2-R18																									
Reference Document	MEF 20 UNI Type 2 Implementation Agreement Section 9 MEF 16 Ethernet Local Management Interface																									
Test Type	Conformance																									
Test Status	Mandatory																									
Requirement Description	If the content of the Report Type Information Element specifies <i>Full Status</i> , then the STATUS message MUST contain one EVC Status Information Element for each EVC configured on the UNI																									
Test Object	Verify that if the content of the Report Type Information Element specifies <i>Full Status</i> , then the STATUS message contains one EVC Status Information Element for each EVC configured on the UNI																									
Test Configuration	At least two EVCs are configured on the UNI "A" MEN Side (UNI-N) and at least one CE-VLAN ID is mapped to each EVC. A per Ingress UNI bandwidth profile is applied at the UNI "A". Configure UNI "A" CE Side with the default value of N393. Configure UNI "A" MEN Side with the default values of N393 and T392. Tester 1 with proper PHYs that match the UNI "A" MEN side and CE side is monitoring the E-LMI frames																									
Test Configuration Schematic																										
CE-VLAN ID/EVC Map	<table border="1" style="width: 100%; border-collapse: collapse;"> <thead> <tr> <th colspan="2" style="background-color: #f4a460;">UNI 'A'</th> </tr> <tr> <th style="background-color: #f4a460;">CE-VLAN ID</th> <th style="background-color: #f4a460;">EVC</th> </tr> </thead> <tbody> <tr> <td style="background-color: #ffffcc;">11*</td> <td style="background-color: #ffffcc;">EVC₁</td> </tr> <tr> <td style="background-color: #ffffcc;">12</td> <td style="background-color: #ffffcc;">EVC₂</td> </tr> </tbody> </table> <p>Use of other EVCs or CE-VLAN IDs is permitted provided that the configuration of the CE-VLAN ID/EVC Map conforms to MEF 10.1</p> <p>The CE-VLAN ID for untagged and priority tagged Service Frames is configured to 11</p>	UNI 'A'		CE-VLAN ID	EVC	11*	EVC ₁	12	EVC ₂																	
UNI 'A'																										
CE-VLAN ID	EVC																									
11*	EVC ₁																									
12	EVC ₂																									
Bandwidth Profile	<table border="1" style="width: 100%; border-collapse: collapse;"> <thead> <tr> <th colspan="4" style="background-color: #f4a460;">PER INGRESS UNI</th> </tr> <tr> <th style="background-color: #f4a460;">UNI</th> <th colspan="3" style="background-color: #f4a460;">Bandwidth Profile Parameters</th> </tr> <tr> <th style="background-color: #ffffcc;">UNI</th> <th style="background-color: #ffffcc;">CIR</th> <th style="background-color: #ffffcc;">CBS</th> <th style="background-color: #ffffcc;">EIR</th> <th style="background-color: #ffffcc;">EBS</th> </tr> </thead> <tbody> <tr> <td colspan="4">Note 1: (0 < CIR < Ingress UNI Speed), (CBS ≥ maximum Service Frame size)</td> </tr> <tr> <td colspan="4">Note 2: (Ingress CIR ≤ Egress UNI Speed)</td> </tr> <tr> <td colspan="4">Note 3: (EIR ≥ 0) and (EBS ≥ 0)</td> </tr> </tbody> </table>	PER INGRESS UNI				UNI	Bandwidth Profile Parameters			UNI	CIR	CBS	EIR	EBS	Note 1: (0 < CIR < Ingress UNI Speed), (CBS ≥ maximum Service Frame size)				Note 2: (Ingress CIR ≤ Egress UNI Speed)				Note 3: (EIR ≥ 0) and (EBS ≥ 0)			
PER INGRESS UNI																										
UNI	Bandwidth Profile Parameters																									
UNI	CIR	CBS	EIR	EBS																						
Note 1: (0 < CIR < Ingress UNI Speed), (CBS ≥ maximum Service Frame size)																										
Note 2: (Ingress CIR ≤ Egress UNI Speed)																										
Note 3: (EIR ≥ 0) and (EBS ≥ 0)																										
Test Procedure	Restart the UNI "A" MEN Side, use the tester 2 to send STATUS ENQUIRY messages and use the tester 1 to monitor the E-LMI messages for a period of time ($T = 3 \times T391$). Verify that when the content of the Report Type Information Element specifies <i>Full Status</i> , then the STATUS message sent by the UNI "A" MEN Side (UNI-N) contains one EVC Status Information Element for each EVC configured on the UNI																									
Units	EVC Status Information Element value																									
Variables	None																									
Results	Pass or fail																									
Remarks	Test Case must be run using T391 in the range (5-30 seconds) and N391 in the range (1-65k). Suggested values for T391 = 5 and N391 = 2.																									

TEST CASE 34N: UNI-N Full Status Continued STATUS Message - EVC Status IE

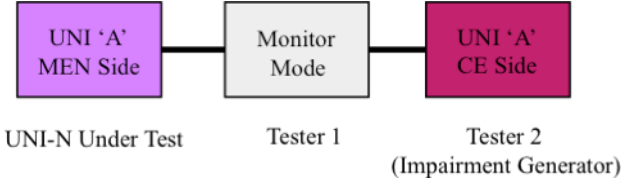
Abstract Test Suite for E-LMI - Procedures																															
Test Name	UNI-N Full Status Continued STATUS Message - EVC Status IE																														
Test Definition ID	UNIN-ELMI-5.6.2-R18																														
Reference Document	MEF 20 UNI Type 2 Implementation Agreement Section 9 MEF 16 Ethernet Local Management Interface																														
Test Type	Conformance																														
Test Status	Mandatory																														
Requirement Description	If the UNI-N cannot fit EVC status Information Elements and service attributes and parameters for all EVCs into a single Full Status STATUS message, the UNI-N MUST respond with a Full Status Continued STATUS message, containing as many EVC Status Information Elements as allowed by the Ethernet frame size																														
Test Object	Verify that if the UNI-N cannot fit EVC status Information Elements and service attributes and parameters for all EVCs into a single Full Status STATUS message, the UNI-N responds with a Full Status Continued STATUS message, containing as many EVC Status Information Elements as allowed by the Ethernet frame size																														
Test Configuration	Multiple EVCs (enough so that the EVC status Information Elements, service attributes and parameters cannot fit into a single Full Status STATUS message) are configured on the UNI "A" MEN Side (UNI-N) and at least one CE-VLAN ID is mapped to each EVC. A per Ingress UNI bandwidth profile is applied at the UNI "A". Configure UNI "A" CE Side with the default value of N393. Configure UNI "A" MEN Side with the default values of N393 and T392. Tester 1 with proper PHYs that match the UNI "A" MEN side and CE side is monitoring the E-LMI frames																														
Test Configuration Schematic																															
CE-VLAN ID/EVC Map	<table border="1"> <thead> <tr> <th colspan="2">UNI 'A'</th> </tr> <tr> <th>CE-VLAN ID</th> <th>EVC</th> </tr> </thead> <tbody> <tr> <td>11*</td> <td>EVC₁</td> </tr> <tr> <td>12</td> <td>EVC₂</td> </tr> </tbody> </table> <p>Use of other EVCs or CE-VLAN IDs is permitted provided that the configuration of the CE-VLAN ID/EVC Map conforms to MEF 10.1</p> <p>The CE-VLAN ID for untagged and priority tagged Service Frames is configured to 11</p>	UNI 'A'		CE-VLAN ID	EVC	11*	EVC ₁	12	EVC ₂																						
UNI 'A'																															
CE-VLAN ID	EVC																														
11*	EVC ₁																														
12	EVC ₂																														
Bandwidth Profile	<table border="1"> <thead> <tr> <th colspan="5">PER INGRESS UNI</th> </tr> <tr> <th>UNI</th> <th colspan="4">Bandwidth Profile Parameters</th> </tr> <tr> <th>UNI</th> <th>CIR</th> <th>CBS</th> <th>EIR</th> <th>EBS</th> </tr> </thead> <tbody> <tr> <td colspan="5">Note 1: (0 < CIR < Ingress UNI Speed), (CBS ≥ maximum Service Frame size)</td> </tr> <tr> <td colspan="5">Note 2: (Ingress CIR ≤ Egress UNI Speed)</td> </tr> <tr> <td colspan="5">Note 3: (EIR ≥ 0) and (EBS ≥ 0)</td> </tr> </tbody> </table>	PER INGRESS UNI					UNI	Bandwidth Profile Parameters				UNI	CIR	CBS	EIR	EBS	Note 1: (0 < CIR < Ingress UNI Speed), (CBS ≥ maximum Service Frame size)					Note 2: (Ingress CIR ≤ Egress UNI Speed)					Note 3: (EIR ≥ 0) and (EBS ≥ 0)				
PER INGRESS UNI																															
UNI	Bandwidth Profile Parameters																														
UNI	CIR	CBS	EIR	EBS																											
Note 1: (0 < CIR < Ingress UNI Speed), (CBS ≥ maximum Service Frame size)																															
Note 2: (Ingress CIR ≤ Egress UNI Speed)																															
Note 3: (EIR ≥ 0) and (EBS ≥ 0)																															
Test Procedure	Restart the UNI "A" MEN Side, use the tester 2 to send STATUS ENQUIRY messages and use the tester 1 to monitor the E-LMI messages for a period of time ($T = 3 \times T391$). Verify that when the UNI "A" MEN side (UNI-N) cannot fit EVC status Information Elements and service attributes and parameters for all EVCs into a single Full Status STATUS message, it responds with a Full Status Continued STATUS message, containing as many EVC Status Information Elements as allowed by the Ethernet frame size																														
Units	Full Status Continued STATUS message value																														
Variables	None																														
Results	Pass or fail																														
Remarks	Test Case must be run using T391 in the range (5-30 seconds) and N391 in the range (1-65k). Suggested values for T391 = 5 and N391 = 2.																														

TEST CASE 35N: UNI-N Response to a Full Status Continued STATUS ENQUIRY Message

Abstract Test Suite for E-LMI - Procedures																															
Test Name	UNI-N Response to a Full Status Continued STATUS ENQUIRY Message																														
Test Definition ID	UNIN-ELMI-5.6.2-R18																														
Reference Document	MEF 20 UNI Type 2 Implementation Agreement Section 9 MEF 16 Ethernet Local Management Interface																														
Test Type	Conformance																														
Test Status	Mandatory																														
Requirement Description	The UNI-N MUST respond to a Full Status Continued STATUS ENQUIRY with a Full Status STATUS or Full Status Continued STATUS message starting at the next EVC Reference ID that follows the last EVC Status Information Element reported by the UNI-N in the previous STATUS message																														
Test Object	Verify that the UNI-N responds to a Full Status Continued STATUS ENQUIRY with a Full Status STATUS or Full Status Continued STATUS message starting at the next EVC Reference ID that follows the last EVC Status Information Element reported by the UNI-N in the previous STATUS message																														
Test Configuration	Multiple EVCs (enough so that the EVC status Information Elements, service attributes and parameters cannot fit into two Full Status Continued and one Full Status STATUS messages) are configured on the UNI "A" MEN Side (UNI-N) and at least one CE-VLAN ID is mapped to each EVC. A per Ingress UNI bandwidth profile is applied at the UNI "A". Configure UNI "A" CE Side with the default value of N393. Configure UNI "A" MEN Side with the default values of N393 and T392. Tester 1 with proper PHYs that match the UNI "A" MEN side and CE side is monitoring the E-LMI frames																														
Test Configuration Schematic																															
CE-VLAN ID/EVC Map	<table border="1"> <thead> <tr> <th colspan="2">UNI 'A'</th> </tr> <tr> <th>CE-VLAN ID</th> <th>EVC</th> </tr> </thead> <tbody> <tr> <td>11*</td> <td>EVC₁</td> </tr> <tr> <td>12</td> <td>EVC₂</td> </tr> </tbody> </table> <p>Use of other EVCs or CE-VLAN IDs is permitted provided that the configuration of the CE-VLAN ID/EVC Map conforms to MEF 10.1</p> <p>The CE-VLAN ID for untagged and priority tagged Service Frames is configured to 11</p>	UNI 'A'		CE-VLAN ID	EVC	11*	EVC ₁	12	EVC ₂																						
UNI 'A'																															
CE-VLAN ID	EVC																														
11*	EVC ₁																														
12	EVC ₂																														
Bandwidth Profile	<table border="1"> <thead> <tr> <th colspan="5">PER INGRESS UNI</th> </tr> <tr> <th>UNI</th> <th colspan="4">Bandwidth Profile Parameters</th> </tr> <tr> <th>UNI</th> <th>CIR</th> <th>CBS</th> <th>EIR</th> <th>EBS</th> </tr> </thead> <tbody> <tr> <td colspan="5">Note 1: (0 < CIR < Ingress UNI Speed), (CBS ≥ maximum Service Frame size)</td> </tr> <tr> <td colspan="5">Note 2: (Ingress CIR ≤ Egress UNI Speed)</td> </tr> <tr> <td colspan="5">Note 3: (EIR ≥ 0) and (EBS ≥ 0)</td> </tr> </tbody> </table>	PER INGRESS UNI					UNI	Bandwidth Profile Parameters				UNI	CIR	CBS	EIR	EBS	Note 1: (0 < CIR < Ingress UNI Speed), (CBS ≥ maximum Service Frame size)					Note 2: (Ingress CIR ≤ Egress UNI Speed)					Note 3: (EIR ≥ 0) and (EBS ≥ 0)				
PER INGRESS UNI																															
UNI	Bandwidth Profile Parameters																														
UNI	CIR	CBS	EIR	EBS																											
Note 1: (0 < CIR < Ingress UNI Speed), (CBS ≥ maximum Service Frame size)																															
Note 2: (Ingress CIR ≤ Egress UNI Speed)																															
Note 3: (EIR ≥ 0) and (EBS ≥ 0)																															
Test Procedure	Restart the UNI "A" MEN Side, use the tester 2 to send STATUS ENQUIRY messages and use the tester 1 to monitor the E-LMI messages for a period of time ($T = 5 \times T391$). Verify that the UNI "A" MEN side (UNI-N) responds to a Full Status Continued STATUS ENQUIRY message with a Full Status STATUS or Full Status Continued STATUS message starting at the next EVC Reference ID that follows the last EVC Status Information Element reported in the previous STATUS message																														
Units	Full Status and Full Status Continued STATUS messages EVC Reference IDs																														
Variables	None																														
Results	Pass or fail																														
Remarks	Test Case must be run using T391 in the range (5-30 seconds) and N391 in the range (1-65k). Suggested values for T391 = 5 and N391 = 2.																														

TEST CASE 43N: Send Sequence Counter - Zero Value Skipped

Abstract Test Suite for E-LMI - Procedures	
Test Name	Send Sequence Counter - Zero Value Skipped
Test Definition ID	UNIN-ELMI-5.6.3-R18
Reference Document	MEF 20 UNI Type 2 Implementation Agreement Section 9 MEF 16 Ethernet Local Management Interface
Test Type	Conformance
Test Status	Mandatory
Requirement Description	The UNI-N increments the send sequence counter using modulo 256. The value zero SHALL be skipped
Test Object	Verify that the UNI-N increments the send sequence counter using modulo 256 and that the value zero is skipped
Test Configuration	Configure UNI "A" CE Side with the default value of N393. Configure UNI "A" MEN Side with the default values of N393 and T392. Tester 1 with proper PHYs that match the UNI "A" MEN side and CE side is monitoring the E-LMI frames
Test Configuration Schematic	
CE-VLAN ID/EVC Map	Not Specified
Bandwidth Profile	Not Specified
Test Procedure	Restart the UNI "A" MEN Side, use the tester 2 to send STATUS ENQUIRY messages and use the tester 1 to monitor the E-LMI messages. Monitor at least 256 consecutive STATUS messages transmitted by the UNI "A" MEN side (UNI-N) and verify that the send sequence number field increments using modulo 256 and that the value zero is skipped
Units	STATUS message send sequence number field value
Variables	None
Results	Pass or fail
Remarks	Test Case must be run using T391 in the range (5-30 seconds) and N391 in the range (1-65k). Suggested values for T391 = 5 and N391 = 2.

TEST CASE 44N: UNI-N Receive and Send Sequence Counters

Abstract Test Suite for E-LMI - Procedures	
Test Name	UNI-N Receive and Send Sequence Counters
Test Definition ID	UNIN-ELMI-5.6.3-R18
Reference Document	MEF 20 UNI Type 2 Implementation Agreement Section 9 MEF 16 Ethernet Local Management Interface
Test Type	Conformance
Test Status	Mandatory
Requirement Description	Upon the receipt of STATUS ENQUIRY message, the received send sequence number SHALL be stored in the UNI-N receive sequence counter. The UNI-N then SHALL increment its send sequence counter and place its current value in the send sequence number field and the value of the receive sequence counter (the last received send sequence number) into the receive sequence number field of the outgoing Sequence Numbers Information Element. The UNI-N then SHALL transmit the completed STATUS message back to the UNI-C
Test Object	Verify that upon the receipt of STATUS ENQUIRY message the received send sequence number is placed into the receive sequence number field of the outgoing Sequence Numbers Information Element in the STATUS message sent back to the UNI-C
Test Configuration	Configure UNI "A" CE Side with the default value of N393. Configure UNI "A" MEN Side with the default values of N393 and T392. Tester 1 with proper PHYs that match the UNI "A" MEN side and CE side is monitoring the E-LMI frames
Test Configuration Schematic	<pre> graph LR A[UNI 'A' MEN Side] --- B[Monitor Mode] B --- C[UNI 'A' CE Side] subgraph Testers B --- T1[Tester 1] C --- T2[Tester 2 (Impairment Generator)] end </pre>
CE-VLAN ID/EVC Map	Not Specified
Bandwidth Profile	Not Specified
Test Procedure	Restart the UNI "A" MEN Side, use the tester 2 to send STATUS ENQUIRY messages and use the tester 1 to monitor the E-LMI messages for a period of time ($T = 3 \times T391$). Verify that upon the receipt of a STATUS ENQUIRY message, the UNI "A" MEN Side (UNI-N) places the proper value of the receive sequence number into the receive sequence number field of the outgoing Sequence Numbers Information Element in the STATUS message sent back to the UNI "A" CE Side
Units	STATUS message send and receive sequence number fields values
Variables	None
Results	Pass or fail
Remarks	Test Case must be run using T391 in the range (5-30 seconds) and N391 in the range (1-65k). Suggested values for T391 = 5 and N391 = 2.

TEST CASE 45N: Asynchronous Status – Report Type

Abstract Test Suite for E-LMI - Procedures																															
Test Name	Asynchronous Status – Report Type																														
Test Definition ID	UNIN-ELMI-5.6.6-R19																														
Reference Document	MEF 20 UNI Type 2 Implementation Agreement Section 9 MEF 16 Ethernet Local Management Interface																														
Test Type	Conformance																														
Test Status	Optional																														
Requirement Description	The Asynchronous STATUS message SHOULD be sent when the UNI-N detects an EVC status change, and the report type SHALL be set to <i>Single EVC Asynchronous Status</i>																														
Test Object	Verify that an Asynchronous STATUS message is sent when the UNI-N detects an EVC status change, and the report type is set to <i>Single EVC Asynchronous Status</i>																														
Test Configuration	At least one EVC associating at least two Type 2 UNIs is configured on the UNI “A” MEN Side (UNI-N) and at least one CE-VLAN ID is mapped to each EVC. A per Ingress UNI bandwidth profile is applied at the UNI “A”. Configure UNI “A” CE Side with the default value of N393. Configure UNI “A” MEN Side with the default values of N393 and T392. Tester 1 with proper PHYs that match the UNI “A” MEN side and CE side is monitoring the E-LMI frames																														
Test Configuration Schematic																															
CE-VLAN ID/EVC Map	<table border="1" style="width: 100%; border-collapse: collapse;"> <thead> <tr> <th colspan="2" style="background-color: #f4a460;">UNI ‘A’</th> </tr> <tr> <th style="width: 50%;">CE-VLAN ID</th> <th style="width: 50%;">EVC</th> </tr> </thead> <tbody> <tr> <td style="text-align: center;">11*</td> <td style="text-align: center;">EVC₁</td> </tr> <tr> <td colspan="2">Use of other EVCs or CE-VLAN IDs is permitted provided that the configuration of the CE-VLAN ID/EVC Map conforms to MEF 10.1</td> </tr> <tr> <td colspan="2">The CE-VLAN ID for untagged and priority tagged Service Frames is configured to 11</td> </tr> </tbody> </table>	UNI ‘A’		CE-VLAN ID	EVC	11*	EVC ₁	Use of other EVCs or CE-VLAN IDs is permitted provided that the configuration of the CE-VLAN ID/EVC Map conforms to MEF 10.1		The CE-VLAN ID for untagged and priority tagged Service Frames is configured to 11																					
UNI ‘A’																															
CE-VLAN ID	EVC																														
11*	EVC ₁																														
Use of other EVCs or CE-VLAN IDs is permitted provided that the configuration of the CE-VLAN ID/EVC Map conforms to MEF 10.1																															
The CE-VLAN ID for untagged and priority tagged Service Frames is configured to 11																															
Bandwidth Profile	<table border="1" style="width: 100%; border-collapse: collapse;"> <thead> <tr> <th colspan="5" style="background-color: #f4a460;">PER INGRESS UNI</th> </tr> <tr> <th style="width: 50%;">UNI</th> <th colspan="4" style="width: 50%;">Bandwidth Profile Parameters</th> </tr> <tr> <th style="text-align: center;">UNI</th> <th style="text-align: center;">CIR</th> <th style="text-align: center;">CBS</th> <th style="text-align: center;">EIR</th> <th style="text-align: center;">EBS</th> </tr> </thead> <tbody> <tr> <td colspan="5">Note 1: (0 < CIR < Ingress UNI Speed), (CBS ≥ maximum Service Frame size)</td> </tr> <tr> <td colspan="5">Note 2: (Ingress CIR ≤ Egress UNI Speed)</td> </tr> <tr> <td colspan="5">Note 3: (EIR ≥ 0) and (EBS ≥ 0)</td> </tr> </tbody> </table>	PER INGRESS UNI					UNI	Bandwidth Profile Parameters				UNI	CIR	CBS	EIR	EBS	Note 1: (0 < CIR < Ingress UNI Speed), (CBS ≥ maximum Service Frame size)					Note 2: (Ingress CIR ≤ Egress UNI Speed)					Note 3: (EIR ≥ 0) and (EBS ≥ 0)				
PER INGRESS UNI																															
UNI	Bandwidth Profile Parameters																														
UNI	CIR	CBS	EIR	EBS																											
Note 1: (0 < CIR < Ingress UNI Speed), (CBS ≥ maximum Service Frame size)																															
Note 2: (Ingress CIR ≤ Egress UNI Speed)																															
Note 3: (EIR ≥ 0) and (EBS ≥ 0)																															
Test Procedure	Restart the UNI “A” MEN Side, use the tester 2 to send STATUS ENQUIRY messages and use the tester 1 to monitor the E-LMI messages for a period of time ($T = 5 \times T391$). After the first Full Status procedure is complete, delete an EVC and verify that a <i>Single EVC Asynchronous Status</i> STATUS message is transmitted by the UNI “A” MEN Side (UNI-N)																														
Units	STATUS message Report Type																														
Variables	None																														
Results	Pass or fail																														
Remarks	Test Case must be run using T391 in the range (5-30 seconds) and N391 in the range (1-65k). Suggested values for T391 = 5 and N391 = 2.																														

TEST CASE 46N: Asynchronous Status Message

Abstract Test Suite for E-LMI - Procedures																															
Test Name	Asynchronous Status Message																														
Test Definition ID	UNIN-ELMI-5.6.6-R18																														
Reference Document	MEF 20 UNI Type 2 Implementation Agreement Section 9 MEF 16 Ethernet Local Management Interface																														
Test Type	Conformance																														
Test Status	Mandatory if <i>Single EVC Asynchronous</i> Status Report is supported																														
Requirement Description	The <i>Single EVC Asynchronous Status</i> STATUS message MUST only contain the EVC Status Information Element																														
Test Object	Verify that the <i>Single EVC Asynchronous Status</i> STATUS message contains only the EVC Status Information Element																														
Test Configuration	At least one EVC associating at least two Type 2 UNIs is configured on the UNI "A" MEN Side (UNI-N) and at least one CE-VLAN ID is mapped to each EVC. A per Ingress UNI bandwidth profile is applied at the UNI "A". Configure UNI "A" CE Side with the default value of N393. Configure UNI "A" MEN Side with the default values of N393 and T392. Tester 1 with proper PHYs that match the UNI "A" MEN side and CE side is monitoring the E-LMI frames																														
Test Configuration Schematic																															
CE-VLAN ID/EVC Map	<table border="1" style="width: 100%; border-collapse: collapse;"> <thead> <tr> <th colspan="2" style="background-color: #f4a460;">UNI 'A'</th> </tr> <tr> <th style="width: 50%;">CE-VLAN ID</th> <th style="width: 50%;">EVC</th> </tr> </thead> <tbody> <tr> <td style="text-align: center;">11*</td> <td style="text-align: center;">EVC₁</td> </tr> <tr> <td colspan="2">Use of other EVCs or CE-VLAN IDs is permitted provided that the configuration of the CE-VLAN ID/EVC Map conforms to MEF 10.1</td> </tr> <tr> <td colspan="2">The CE-VLAN ID for untagged and priority tagged Service Frames is configured to 11</td> </tr> </tbody> </table>	UNI 'A'		CE-VLAN ID	EVC	11*	EVC ₁	Use of other EVCs or CE-VLAN IDs is permitted provided that the configuration of the CE-VLAN ID/EVC Map conforms to MEF 10.1		The CE-VLAN ID for untagged and priority tagged Service Frames is configured to 11																					
UNI 'A'																															
CE-VLAN ID	EVC																														
11*	EVC ₁																														
Use of other EVCs or CE-VLAN IDs is permitted provided that the configuration of the CE-VLAN ID/EVC Map conforms to MEF 10.1																															
The CE-VLAN ID for untagged and priority tagged Service Frames is configured to 11																															
Bandwidth Profile	<table border="1" style="width: 100%; border-collapse: collapse;"> <thead> <tr> <th colspan="5" style="background-color: #f4a460;">PER INGRESS UNI</th> </tr> <tr> <th style="width: 50%;">UNI</th> <th colspan="4" style="width: 50%;">Bandwidth Profile Parameters</th> </tr> <tr> <th style="text-align: center;">UNI</th> <th style="text-align: center;">CIR</th> <th style="text-align: center;">CBS</th> <th style="text-align: center;">EIR</th> <th style="text-align: center;">EBS</th> </tr> </thead> <tbody> <tr> <td colspan="5">Note 1: (0 < CIR < Ingress UNI Speed), (CBS ≥ maximum Service Frame size)</td> </tr> <tr> <td colspan="5">Note 2: (Ingress CIR ≤ Egress UNI Speed)</td> </tr> <tr> <td colspan="5">Note 3: (EIR ≥ 0) and (EBS ≥ 0)</td> </tr> </tbody> </table>	PER INGRESS UNI					UNI	Bandwidth Profile Parameters				UNI	CIR	CBS	EIR	EBS	Note 1: (0 < CIR < Ingress UNI Speed), (CBS ≥ maximum Service Frame size)					Note 2: (Ingress CIR ≤ Egress UNI Speed)					Note 3: (EIR ≥ 0) and (EBS ≥ 0)				
PER INGRESS UNI																															
UNI	Bandwidth Profile Parameters																														
UNI	CIR	CBS	EIR	EBS																											
Note 1: (0 < CIR < Ingress UNI Speed), (CBS ≥ maximum Service Frame size)																															
Note 2: (Ingress CIR ≤ Egress UNI Speed)																															
Note 3: (EIR ≥ 0) and (EBS ≥ 0)																															
Test Procedure	Restart the UNI "A" MEN Side, use the tester 2 to send STATUS ENQUIRY messages and use the tester 1 to monitor the E-LMI messages for a period of time ($T = 5 \times T391$). After the first Full Status procedure is complete, delete an EVC and verify that the <i>Single EVC Asynchronous Status</i> STATUS message sent by the UNI "A" MEN Side (UNI-N) contains only the EVC Status Information Element																														
Units	STATUS message Information Elements																														
Variables	None																														
Results	Pass or fail																														
Remarks	Test Case must be run using T391 in the range (5-30 seconds) and N391 in the range (1-65k). Suggested values for T391 = 5 and N391 = 2.																														

TEST CASE 47N: Interval Between Single EVC Asynchronous Status Messages

Abstract Test Suite for E-LMI - Procedures													
Test Name	Interval Between Single EVC Asynchronous Status Message												
Test Definition ID	UNIN-ELMI-5.6.6-R22												
Reference Document	MEF 20 UNI Type 2 Implementation Agreement Section 9 MEF 16 Ethernet Local Management Interface												
Test Type	Conformance												
Test Status	Optional												
Requirement Description	The interval between <i>Single EVC Asynchronous Status</i> STATUS messages SHOULD be greater than or equal to 1/10 th of T391												
Test Object	Verify that the interval between <i>Single EVC Asynchronous Status</i> STATUS messages is greater than or equal to 1/10 th of T391												
Test Configuration	At least two EVCs associating at least two Type 2 UNIs are configured on the UNI "A" MEN Side (UNI-N) and at least one CE-VLAN ID is mapped to each EVC. A per Ingress UNI bandwidth profile is applied at the UNI "A". Configure UNI "A" CE Side with the default value of N393. Configure UNI "A" MEN Side with the default values of N393 and T392. Tester 1 with proper PHYs that match the UNI "A" MEN side and CE side is monitoring the E-LMI frames												
Test Configuration Schematic													
CE-VLAN ID/EVC Map	<table border="1" style="width: 100%; border-collapse: collapse;"> <thead> <tr> <th colspan="2" style="background-color: #f4a460;">UNI 'A'</th> </tr> <tr> <th style="width: 50%;">CE-VLAN ID</th> <th style="width: 50%;">EVC</th> </tr> </thead> <tbody> <tr> <td style="text-align: center;">11*</td> <td style="text-align: center;">EVC₁</td> </tr> <tr> <td style="text-align: center;">12</td> <td style="text-align: center;">EVC₂</td> </tr> <tr> <td colspan="2">Use of other EVCs or CE-VLAN IDs is permitted provided that the configuration of the CE-VLAN ID/EVC Map conforms to MEF 10.1</td> </tr> <tr> <td colspan="2">The CE-VLAN ID for untagged and priority tagged Service Frames is configured to 11</td> </tr> </tbody> </table>	UNI 'A'		CE-VLAN ID	EVC	11*	EVC ₁	12	EVC ₂	Use of other EVCs or CE-VLAN IDs is permitted provided that the configuration of the CE-VLAN ID/EVC Map conforms to MEF 10.1		The CE-VLAN ID for untagged and priority tagged Service Frames is configured to 11	
UNI 'A'													
CE-VLAN ID	EVC												
11*	EVC ₁												
12	EVC ₂												
Use of other EVCs or CE-VLAN IDs is permitted provided that the configuration of the CE-VLAN ID/EVC Map conforms to MEF 10.1													
The CE-VLAN ID for untagged and priority tagged Service Frames is configured to 11													
Bandwidth Profile	<table border="1" style="width: 100%; border-collapse: collapse;"> <thead> <tr> <th colspan="2" style="background-color: #f4a460;">PER INGRESS UNI</th> </tr> <tr> <th style="width: 50%;">UNI</th> <th style="width: 50%;">Bandwidth Profile Parameters</th> </tr> <tr> <th style="background-color: #ffff00;">UNI</th> <th style="background-color: #ffff00;">CIR CBS EIR EBS</th> </tr> </thead> <tbody> <tr> <td colspan="2">Note 1: (0 < CIR < Ingress UNI Speed), (CBS ≥ maximum Service Frame size)</td> </tr> <tr> <td colspan="2">Note 2: (Ingress CIR ≤ Egress UNI Speed)</td> </tr> <tr> <td colspan="2">Note 3: (EIR ≥ 0) and (EBS ≥ 0)</td> </tr> </tbody> </table>	PER INGRESS UNI		UNI	Bandwidth Profile Parameters	UNI	CIR CBS EIR EBS	Note 1: (0 < CIR < Ingress UNI Speed), (CBS ≥ maximum Service Frame size)		Note 2: (Ingress CIR ≤ Egress UNI Speed)		Note 3: (EIR ≥ 0) and (EBS ≥ 0)	
PER INGRESS UNI													
UNI	Bandwidth Profile Parameters												
UNI	CIR CBS EIR EBS												
Note 1: (0 < CIR < Ingress UNI Speed), (CBS ≥ maximum Service Frame size)													
Note 2: (Ingress CIR ≤ Egress UNI Speed)													
Note 3: (EIR ≥ 0) and (EBS ≥ 0)													
Test Procedure	Restart the UNI "A" MEN Side, use the tester 2 to send STATUS ENQUIRY messages and use the tester 1 to monitor the E-LMI messages for a period of time ($T = 5 \times T391$). After the first Full Status procedure is complete, delete two EVCs and verify that the time interval between the two <i>Single EVC Asynchronous Status</i> STATUS messages transmitted by the UNI "A" MEN Side (UNI-N) is greater than or equal to 1/10 th of T391												
Units	Seconds												
Variables	None												
Results	Pass or fail												
Remarks	Test Case must be run using T391 in the range (5-30 seconds) and N391 in the range (1-65k). Suggested values for T391 = 5 and N391 = 2. The configuration of the Minimum Asynchronous Message Interval should be in the range (0.5-3 seconds). Suggested value for Minimum Asynchronous Message Interval = 1												

TEST CASE 53N: Initial DI Value

Abstract Test Suite for E-LMI - Procedures	
Test Name	Initial DI Value
Test Definition ID	UNIN-ELMI-5.6.7.2-R18
Reference Document	MEF 20 UNI Type 2 Implementation Agreement Section 9 MEF 16 Ethernet Local Management Interface
Test Type	Conformance
Test Status	Mandatory
Requirement Description	When the UNI-N first comes up, it SHALL set its DI value to a non-zero value that is different from the DI value received in the first message from the UNI-C
Test Object	Verify that when the UNI-N first comes up, it sets its DI value to a non-zero value that is different from the DI value received in the first message from the UNI-C
Test Configuration	Configure UNI "A" CE Side with the default value of N393. Configure UNI "A" MEN Side with the default values of N393 and T392. Tester 1 with proper PHYs that match the UNI "A" MEN side and CE side is monitoring the E-LMI frames
Test Configuration Schematic	
CE-VLAN ID/EVC Map	Not Specified
Bandwidth Profile	Not Specified
Test Procedure	Restart the UNI "A" MEN Side, use the tester 2 to send STATUS ENQUIRY messages and use the tester 1 to monitor the E-LMI messages for a period of time ($T = 3 \times T391$). Verify that when the UNI "A" MEN Side (UNI-N) first comes up, it sets its DI value to a non-zero value that is different from the DI value received in the first message from the UNI-C (which is set to 0)
Units	STATUS message Data Instance value
Variables	None
Results	Pass or fail
Remarks	Test Case must be run using T391 in the range (5-30 seconds) and N391 in the range (1-65k). Suggested values for T391 = 5 and N391 = 2.

TEST CASE 54N: UNI Change of Information

Abstract Test Suite for E-LMI - Procedures	
Test Name	UNI Change of Information
Test Definition ID	UNIN-ELMI-5.6.7.2-R18
Reference Document	MEF 20 UNI Type 2 Implementation Agreement Section 9 MEF 16 Ethernet Local Management Interface
Test Type	Conformance
Test Status	Mandatory
Requirement Description	Any change in information related to UNI SHALL result in incrementing DI value to reflect the change in data
Test Object	Verify that any change in information related to UNI results in incrementing DI value to reflect the change in data
Test Configuration	Configure UNI "A" CE Side with the default value of N393. Configure UNI "A" MEN Side with the default values of N393 and T392. Tester 1 with proper PHYs that match the UNI "A" MEN side and CE side is monitoring the E-LMI frames
Test Configuration Schematic	
CE-VLAN ID/EVC Map	Not Specified
Bandwidth Profile	Not Specified
Test Procedure	Restart the UNI "A" MEN Side, use the tester 2 to send STATUS ENQUIRY message and use the tester 1 to monitor the E-LMI messages for a period of time ($T = 5 \times T391$). After the first Full Status procedure is complete, modify the UNI "A" MEN Side's UNI identifier and verify that the DI value of the next STATUS message transmitted by the UNI "A" MEN Side after the modification has been incremented
Units	STATUS message Data Instance value
Variables	None
Results	Pass or fail
Remarks	Test Case must be run using T391 in the range (5-30 seconds) and N391 in the range (1-65k). Suggested values for T391 = 5 and N391 = 2.

TEST CASE 55N: EVC Change of Information

Abstract Test Suite for E-LMI - Procedures																															
Test Name	EVC Change of Information																														
Test Definition ID	UNIN-ELMI-5.6.7.2-R18																														
Reference Document	MEF 20 UNI Type 2 Implementation Agreement Section 9 MEF 16 Ethernet Local Management Interface																														
Test Type	Conformance																														
Test Status	Mandatory																														
Requirement Description	Any change in information related to EVC including status change SHALL result in incrementing DI value to reflect the change in data																														
Test Object	Verify that any change in information related to EVC including status change results in incrementing DI value to reflect the change in data																														
Test Configuration	At least one EVC is configured on the UNI "A" MEN Side (UNI-N) and at least one CE-VLAN ID is mapped to each EVC. A per Ingress UNI bandwidth profile is applied at the UNI "A". Configure UNI "A" CE Side with the default value of N393. Configure UNI "A" MEN Side with the default values of N393 and T392. Tester 1 with proper PHYs that match the UNI "A" MEN side and CE side is monitoring the E-LMI frames																														
Test Configuration Schematic																															
CE-VLAN ID/EVC Map	<table border="1" style="width: 100%; border-collapse: collapse;"> <thead> <tr> <th colspan="2" style="text-align: center;">UNI 'A'</th> </tr> <tr> <th style="width: 50%;">CE-VLAN ID</th> <th style="width: 50%;">EVC</th> </tr> </thead> <tbody> <tr> <td style="text-align: center;">11*</td> <td style="text-align: center;">EVC₁</td> </tr> <tr> <td colspan="2">Use of other EVCs or CE-VLAN IDs is permitted provided that the configuration of the CE-VLAN ID/EVC Map conforms to MEF 10.1</td> </tr> <tr> <td colspan="2">The CE-VLAN ID for untagged and priority tagged Service Frames is configured to 11</td> </tr> </tbody> </table>	UNI 'A'		CE-VLAN ID	EVC	11*	EVC ₁	Use of other EVCs or CE-VLAN IDs is permitted provided that the configuration of the CE-VLAN ID/EVC Map conforms to MEF 10.1		The CE-VLAN ID for untagged and priority tagged Service Frames is configured to 11																					
UNI 'A'																															
CE-VLAN ID	EVC																														
11*	EVC ₁																														
Use of other EVCs or CE-VLAN IDs is permitted provided that the configuration of the CE-VLAN ID/EVC Map conforms to MEF 10.1																															
The CE-VLAN ID for untagged and priority tagged Service Frames is configured to 11																															
Bandwidth Profile	<table border="1" style="width: 100%; border-collapse: collapse;"> <thead> <tr> <th colspan="5" style="text-align: center;">PER INGRESS UNI</th> </tr> <tr> <th style="width: 50%;">UNI</th> <th colspan="4" style="text-align: center;">Bandwidth Profile Parameters</th> </tr> <tr> <th style="text-align: center;">UNI</th> <th style="text-align: center;">CIR</th> <th style="text-align: center;">CBS</th> <th style="text-align: center;">EIR</th> <th style="text-align: center;">EBS</th> </tr> </thead> <tbody> <tr> <td colspan="5">Note 1: (0 < CIR < Ingress UNI Speed), (CBS ≥ maximum Service Frame size)</td> </tr> <tr> <td colspan="5">Note 2: (Ingress CIR ≤ Egress UNI Speed)</td> </tr> <tr> <td colspan="5">Note 3: (EIR ≥ 0) and (EBS ≥ 0)</td> </tr> </tbody> </table>	PER INGRESS UNI					UNI	Bandwidth Profile Parameters				UNI	CIR	CBS	EIR	EBS	Note 1: (0 < CIR < Ingress UNI Speed), (CBS ≥ maximum Service Frame size)					Note 2: (Ingress CIR ≤ Egress UNI Speed)					Note 3: (EIR ≥ 0) and (EBS ≥ 0)				
PER INGRESS UNI																															
UNI	Bandwidth Profile Parameters																														
UNI	CIR	CBS	EIR	EBS																											
Note 1: (0 < CIR < Ingress UNI Speed), (CBS ≥ maximum Service Frame size)																															
Note 2: (Ingress CIR ≤ Egress UNI Speed)																															
Note 3: (EIR ≥ 0) and (EBS ≥ 0)																															
Test Procedure	Restart the UNI "A" MEN Side, use the tester 2 to send STATUS ENQUIRY messages, and use the tester 1 to monitor the E-LMI messages for a period of time ($T = 5 \times T391$). After the first Full Status procedure is complete, delete an EVC and verify that the DI value of the next STATUS message that contains a DI Information Element transmitted by the UNI "A" MEN Side (UNI-N) after the modification has been incremented																														
Units	STATUS message Data Instance value																														
Variables	None																														
Results	Pass or fail																														
Remarks	Test Case must be run using T391 in the range (5-30 seconds) and N391 in the range (1-65k). Suggested values for T391 = 5 and N391 = 2.																														

TEST CASE 56N: Full Status and Full Status Continued reports DI value

Abstract Test Suite for E-LMI - Procedures																															
Test Name	Full Status and Full Status Continued reports DI value																														
Test Definition ID	UNIN-ELMI-5.6.7.2-R18																														
Reference Document	MEF 20 UNI Type 2 Implementation Agreement Section 9 MEF 16 Ethernet Local Management Interface																														
Test Type	Conformance																														
Test Status	Mandatory																														
Requirement Description	For Full Status and Full Status Continued reports, the DI value sent by the UNI-N MUST NOT change from that sent in the first Full Status Continued report until the Status procedure is complete																														
Test Object	Verify that for Full Status and Full Status Continued reports, the DI value sent by the UNI-N does not change from that sent in the first Full Status Continued report until the Status procedure is complete																														
Test Configuration	Multiple EVCs (enough so that the EVC status information elements, service attributes and parameters cannot fit into a single Full Status STATUS message) are configured on the UNI "A" MEN Side (UNI-N) and at least one CE-VLAN ID is mapped to each EVC. A per Ingress UNI bandwidth profile is applied at the UNI "A". Configure UNI "A" CE Side with the default value of N393. Configure UNI "A" MEN Side with the default values of N393 and T392. Tester 1 with proper PHYs that match the UNI "A" MEN side and CE side is monitoring the E-LMI frames																														
Test Configuration Schematic																															
CE-VLAN ID/EVC Map	<table border="1" style="width: 100%; border-collapse: collapse;"> <thead> <tr> <th colspan="2" style="text-align: center;">UNI "A"</th> </tr> <tr> <th style="text-align: center;">CE-VLAN ID</th> <th style="text-align: center;">EVC</th> </tr> </thead> <tbody> <tr> <td style="text-align: center;">11*</td> <td style="text-align: center;">EVC₁</td> </tr> <tr> <td style="text-align: center;">12</td> <td style="text-align: center;">EVC₂</td> </tr> </tbody> </table> <p>Use of other EVCs or CE-VLAN IDs is permitted provided that the configuration of the CE-VLAN ID/EVC Map conforms to MEF 10.1</p> <p>The CE-VLAN ID for untagged and priority tagged Service Frames is configured to 11</p>	UNI "A"		CE-VLAN ID	EVC	11*	EVC ₁	12	EVC ₂																						
UNI "A"																															
CE-VLAN ID	EVC																														
11*	EVC ₁																														
12	EVC ₂																														
Bandwidth Profile	<table border="1" style="width: 100%; border-collapse: collapse;"> <thead> <tr> <th colspan="5" style="text-align: center;">PER INGRESS UNI</th> </tr> <tr> <th style="text-align: center;">UNI</th> <th colspan="4" style="text-align: center;">Bandwidth Profile Parameters</th> </tr> <tr> <th style="text-align: center;">UNI</th> <th style="text-align: center;">CIR</th> <th style="text-align: center;">CBS</th> <th style="text-align: center;">EIR</th> <th style="text-align: center;">EBS</th> </tr> </thead> <tbody> <tr> <td colspan="5">Note 1: (0 < CIR < Ingress UNI Speed), (CBS ≥ maximum Service Frame size)</td> </tr> <tr> <td colspan="5">Note 2: (Ingress CIR ≤ Egress UNI Speed)</td> </tr> <tr> <td colspan="5">Note 3: (EIR ≥ 0) and (EBS ≥ 0)</td> </tr> </tbody> </table>	PER INGRESS UNI					UNI	Bandwidth Profile Parameters				UNI	CIR	CBS	EIR	EBS	Note 1: (0 < CIR < Ingress UNI Speed), (CBS ≥ maximum Service Frame size)					Note 2: (Ingress CIR ≤ Egress UNI Speed)					Note 3: (EIR ≥ 0) and (EBS ≥ 0)				
PER INGRESS UNI																															
UNI	Bandwidth Profile Parameters																														
UNI	CIR	CBS	EIR	EBS																											
Note 1: (0 < CIR < Ingress UNI Speed), (CBS ≥ maximum Service Frame size)																															
Note 2: (Ingress CIR ≤ Egress UNI Speed)																															
Note 3: (EIR ≥ 0) and (EBS ≥ 0)																															
Test Procedure	Restart the UNI "A" MEN Side, use the tester 2 to send STATUS ENQUIRY messages and use the tester 1 to monitor the E-LMI messages for a period of time ($T = 5 \times T391$). Verify that for Full Status and Full Status Continued reports, the DI value sent by the UNI "A" MEN Side (UNI-N) does not change from that sent in the first Full Status Continued report until the Status procedure is complete																														
Units	Full Status and Full Status Continued STATUS messages DI values																														
Variables	None																														
Results	Pass or fail																														
Remarks	Test Case must be run using T391 in the range (5-30 seconds) and N391 in the range (1-65k). Suggested values for T391 = 5 and N391 = 2.																														

TEST CASE 57N: E-LMI STATUS ENQUIRY with E-LMI Check

Abstract Test Suite for E-LMI - Procedures	
Test Name	E-LMI STATUS ENQUIRY with E-LMI Check
Test Definition ID	UNIN-ELMI-5.6.7.2-R18
Reference Document	MEF 20 UNI Type 2 Implementation Agreement Section 9 MEF 16 Ethernet Local Management Interface
Test Type	Conformance
Test Status	Mandatory
Requirement Description	On receipt of E-LMI STATUS ENQUIRY with E-LMI Check, the UNI-N SHALL respond with E-LMI STATUS and include the current value of DI
Test Object	Verify that on receipt of E-LMI STATUS ENQUIRY with E-LMI Check, the UNI-N responds with E-LMI STATUS and includes the current value of DI
Test Configuration	Configure UNI "A" CE Side with the default value of N393. Configure UNI "A" MEN Side with the default values of N393 and T392. Tester 1 with proper PHYs that match the UNI "A" MEN side and CE side is monitoring the E-LMI frames
Test Configuration Schematic	
CE-VLAN ID/EVC Map	Not Specified
Bandwidth Profile	Not Specified
Test Procedure	Restart the UNI "A" MEN Side and the use tester 2 to send STATUS ENQUIRY messages. While holding all UNI and EVC information fixed, use the tester 1 to monitor the E-LMI messages for a period of time ($T = 3 \times T391$) and take note of the STATUS messages DI values. Verify that on receipt of an E-LMI STATUS ENQUIRY with E-LMI Check, the UNI-N responds with E-LMI STATUS and include the current value of DI
Units	STATUS message Data Instance value
Variables	None
Results	Pass or fail
Remarks	Test Case must be run using T391 in the range (5-30 seconds) and N391 in the range (1-65k). Suggested values for T391 = 5 and N391 = 2.

TEST CASE 58N: Addition of a New EVC - Full Status Report

Abstract Test Suite for E-LMI - Procedures																															
Test Name	Addition of a New EVC - Full Status Report																														
Test Definition ID	UNIN-ELMI-5.6.8-R18																														
Reference Document	MEF 20 UNI Type 2 Implementation Agreement Section 9 MEF 16 Ethernet Local Management Interface																														
Test Type	Conformance																														
Test Status	Mandatory																														
Requirement Description	When a new Ethernet Virtual Connection has been added, the UNI-N SHALL increment its DI and set the “New” bit to 1 in the EVC Status Information Element for that EVC in the next <i>Full Status</i> STATUS message sent after the addition of the EVC																														
Test Object	Verify that when a new Ethernet Virtual Connection has been added, the UNI-N increments its DI and sets the “New” bit to 1 in the EVC Status Information Element for that EVC in the next <i>Full Status</i> STATUS message sent after the addition of the EVC																														
Test Configuration	At least one EVC is configured on the UNI “A” MEN Side (UNI-N) and at least one CE-VLAN ID is mapped to each EVC. A per Ingress UNI bandwidth profile is applied at the UNI “A”. Configure UNI “A” CE Side with the default value of N393. Configure UNI “A” MEN Side with the default values of N393 and T392. Tester 1 with proper PHYs that match the UNI “A” MEN side and CE side is monitoring the E-LMI frames																														
Test Configuration Schematic																															
CE-VLAN ID/EVC Map	<table border="1" style="width: 100%; border-collapse: collapse;"> <thead> <tr> <th colspan="2" style="text-align: center;">UNI ‘A’</th> </tr> <tr> <th style="text-align: center;">CE-VLAN ID</th> <th style="text-align: center;">EVC</th> </tr> </thead> <tbody> <tr> <td style="text-align: center;">11*</td> <td style="text-align: center;">EVC₁</td> </tr> </tbody> </table> <p>Use of other EVCs or CE-VLAN IDs is permitted provided that the configuration of the CE-VLAN ID/EVC Map conforms to MEF 10.1</p> <p>The CE-VLAN ID for untagged and priority tagged Service Frames is configured to 11</p>	UNI ‘A’		CE-VLAN ID	EVC	11*	EVC ₁																								
UNI ‘A’																															
CE-VLAN ID	EVC																														
11*	EVC ₁																														
Bandwidth Profile	<table border="1" style="width: 100%; border-collapse: collapse;"> <thead> <tr> <th colspan="5" style="text-align: center;">PER INGRESS UNI</th> </tr> <tr> <th style="text-align: center;">UNI</th> <th colspan="4" style="text-align: center;">Bandwidth Profile Parameters</th> </tr> <tr> <th style="text-align: center;">UNI</th> <th style="text-align: center;">CIR</th> <th style="text-align: center;">CBS</th> <th style="text-align: center;">EIR</th> <th style="text-align: center;">EBS</th> </tr> </thead> <tbody> <tr> <td colspan="5">Note 1: (0 < CIR < Ingress UNI Speed), (CBS ≥ maximum Service Frame size)</td> </tr> <tr> <td colspan="5">Note 2: (Ingress CIR ≤ Egress UNI Speed)</td> </tr> <tr> <td colspan="5">Note 3: (EIR ≥ 0) and (EBS ≥ 0)</td> </tr> </tbody> </table>	PER INGRESS UNI					UNI	Bandwidth Profile Parameters				UNI	CIR	CBS	EIR	EBS	Note 1: (0 < CIR < Ingress UNI Speed), (CBS ≥ maximum Service Frame size)					Note 2: (Ingress CIR ≤ Egress UNI Speed)					Note 3: (EIR ≥ 0) and (EBS ≥ 0)				
PER INGRESS UNI																															
UNI	Bandwidth Profile Parameters																														
UNI	CIR	CBS	EIR	EBS																											
Note 1: (0 < CIR < Ingress UNI Speed), (CBS ≥ maximum Service Frame size)																															
Note 2: (Ingress CIR ≤ Egress UNI Speed)																															
Note 3: (EIR ≥ 0) and (EBS ≥ 0)																															
Test Procedure	Restart the UNI “A” MEN Side, use the tester 2 to send STATUS ENQUIRY messages and use the tester 1 to monitor the E-LMI messages for a period of time ($T = 5 \times T391$). After the first Full Status procedure is complete, add a new EVC in the UNI “A” MEN Side (UNI-N) and verify that the DI value of the next <i>Full Status</i> STATUS message transmitted by the UNI “A” MEN Side (UNI-N) after the addition has been incremented and that the “New” bit in the EVC Status Information Element for that EVC is set to one																														
Units	Data Instance and “New” bit in the EVC Status Information Element values																														
Variables	None																														
Results	Pass or fail																														
Remarks	Test Case must be run using T391 in the range (5-30 seconds) and N391 in the range (1-65k). Suggested values for T391 = 5 and N391 = 2.																														

TEST CASE 59N: Addition of a New EVC - Full Status Continued Report

Abstract Test Suite for E-LMI - Procedures																															
Test Name	Addition of a New EVC - Full Status Continued Report																														
Test Definition ID	UNIN-ELMI-5.6.8-R18																														
Reference Document	MEF 20 UNI Type 2 Implementation Agreement Section 9 MEF 16 Ethernet Local Management Interface																														
Test Type	Conformance																														
Test Status	Mandatory																														
Requirement Description	When a new Ethernet Virtual Connection has been added, the UNI-N SHALL increment its DI and set the “New” bit to 1 in the EVC Status Information Element for that EVC in the next <i>Full Status Continued STATUS</i> message sent after the addition of the EVC																														
Test Object	Verify that when a new Ethernet Virtual Connection has been added, the UNI-N increments its DI and sets the “New” bit to 1 in the EVC Status Information Element for that EVC in the next <i>Full Status Continued STATUS</i> message sent after the addition of the EVC																														
Test Configuration	Multiple EVCs (enough so that the EVC status information elements, service attributes and parameters cannot fit into a single <i>Full Status STATUS</i> message) are configured on the UNI “A” MEN Side (UNI-N) and at least one CE-VLAN ID is mapped to each EVC. A per Ingress UNI bandwidth profile is applied at the UNI “A”. Configure UNI “A” CE Side with the default value of N393. Configure UNI “A” MEN Side with the default values of N393 and T392. Tester 1 with proper PHYs that match the UNI “A” MEN side and CE side is monitoring the E-LMI frames																														
Test Configuration Schematic																															
CE-VLAN ID/EVC Map	<table border="1" style="width: 100%; border-collapse: collapse;"> <thead> <tr> <th colspan="2" style="background-color: #f4a460;">UNI ‘A’</th> </tr> <tr> <th style="background-color: #f4a460;">CE-VLAN ID</th> <th style="background-color: #f4a460;">EVC</th> </tr> </thead> <tbody> <tr> <td style="background-color: #ffffcc;">11*</td> <td style="background-color: #ffffcc;">EVC₁</td> </tr> <tr> <td style="background-color: #ffffcc;">12</td> <td style="background-color: #ffffcc;">EVC₂</td> </tr> <tr> <td colspan="2">Use of other EVCs or CE-VLAN IDs is permitted provided that the configuration of the CE-VLAN ID/EVC Map conforms to MEF 10.1</td> </tr> <tr> <td colspan="2">The CE-VLAN ID for untagged and priority tagged Service Frames is configured to 11</td> </tr> </tbody> </table>	UNI ‘A’		CE-VLAN ID	EVC	11*	EVC ₁	12	EVC ₂	Use of other EVCs or CE-VLAN IDs is permitted provided that the configuration of the CE-VLAN ID/EVC Map conforms to MEF 10.1		The CE-VLAN ID for untagged and priority tagged Service Frames is configured to 11																			
UNI ‘A’																															
CE-VLAN ID	EVC																														
11*	EVC ₁																														
12	EVC ₂																														
Use of other EVCs or CE-VLAN IDs is permitted provided that the configuration of the CE-VLAN ID/EVC Map conforms to MEF 10.1																															
The CE-VLAN ID for untagged and priority tagged Service Frames is configured to 11																															
Bandwidth Profile	<table border="1" style="width: 100%; border-collapse: collapse;"> <thead> <tr> <th colspan="5" style="background-color: #f4a460;">PER INGRESS UNI</th> </tr> <tr> <th style="background-color: #f4a460;">UNI</th> <th colspan="4" style="background-color: #f4a460;">Bandwidth Profile Parameters</th> </tr> <tr> <th style="background-color: #f4a460;">UNI</th> <th style="background-color: #ffffcc;">CIR</th> <th style="background-color: #ffffcc;">CBS</th> <th style="background-color: #ffffcc;">EIR</th> <th style="background-color: #ffffcc;">EBS</th> </tr> </thead> <tbody> <tr> <td colspan="5">Note 1: (0 < CIR < Ingress UNI Speed), (CBS ≥ maximum Service Frame size)</td> </tr> <tr> <td colspan="5">Note 2: (Ingress CIR ≤ Egress UNI Speed)</td> </tr> <tr> <td colspan="5">Note 3: (EIR ≥ 0) and (EBS ≥ 0)</td> </tr> </tbody> </table>	PER INGRESS UNI					UNI	Bandwidth Profile Parameters				UNI	CIR	CBS	EIR	EBS	Note 1: (0 < CIR < Ingress UNI Speed), (CBS ≥ maximum Service Frame size)					Note 2: (Ingress CIR ≤ Egress UNI Speed)					Note 3: (EIR ≥ 0) and (EBS ≥ 0)				
PER INGRESS UNI																															
UNI	Bandwidth Profile Parameters																														
UNI	CIR	CBS	EIR	EBS																											
Note 1: (0 < CIR < Ingress UNI Speed), (CBS ≥ maximum Service Frame size)																															
Note 2: (Ingress CIR ≤ Egress UNI Speed)																															
Note 3: (EIR ≥ 0) and (EBS ≥ 0)																															
Test Procedure	Restart the UNI “A” MEN Side, use the tester 2 to send STATUS ENQUIRY messages and use the tester 1 to monitor the E-LMI messages for a period of time ($T = 5 \times T391$). After the first Full Status procedure is complete, add a new EVC in the UNI “A” MEN Side (UNI-N) and verify that the DI value of the next <i>Full Status Continued STATUS</i> message transmitted by the UNI “A” MEN Side (UNI-N) after the addition has been incremented and that the “New” bit in the EVC Status Information Element for that EVC is set to one																														
Units	Data Instance and “New” bit in the EVC Status Information Element values																														
Variables	None																														
Results	Pass or fail																														
Remarks	Test Case must be run using T391 in the range (5-30 seconds) and N391 in the range (1-65k). Suggested values for T391 = 5 and N391 = 2. The new EVC must be such that it is reported in a <i>Full Status Continued STATUS</i> message.																														

TEST CASE 60N: Addition of a New EVC “New” Bit Set to 1

Abstract Test Suite for E-LMI - Procedures																															
Test Name	Addition of a New EVC “New” Bit Set to 1																														
Test Definition ID	UNIN-ELMI-5.6.8-R18																														
Reference Document	MEF 20 UNI Type 2 Implementation Agreement Section 9 MEF 16 Ethernet Local Management Interface																														
Test Type	Conformance																														
Test Status	Mandatory																														
Requirement Description	When a new Ethernet Virtual Connection has been added, the “New” bit in the EVC Status Information Element SHALL be set to 1 until the DI in the STATUS ENQUIRY message received by the UNI-N is equal to the DI sent by the UNI-N in the messages in which the “New” bit was set to 1																														
Test Object	Verify that when a new Ethernet Virtual Connection is added, the “New” bit in the EVC Status Information Element is set to 1 until the DI in the STATUS ENQUIRY message received by the UNI-N is equal to the DI sent by the UNI-N in the messages in which the “New” bit was set to 1																														
Test Configuration	At least one EVC is configured on the UNI “A” MEN Side (UNI-N) and at least one CE-VLAN ID is mapped to each EVC. A per Ingress UNI bandwidth profile is applied at the UNI “A”. Configure UNI “A” CE Side with the default value of N393. Configure UNI “A” MEN Side with the default values of N393 and T392. Tester 1 with proper PHYs that match the UNI “A” MEN side and CE side is monitoring the E-LMI frames																														
Test Configuration Schematic																															
CE-VLAN ID/EVC Map	<table border="1" style="width: 100%; border-collapse: collapse;"> <thead> <tr> <th colspan="2" style="text-align: center;">UNI ‘A’</th> </tr> <tr> <th style="text-align: center;">CE-VLAN ID</th> <th style="text-align: center;">EVC</th> </tr> </thead> <tbody> <tr> <td style="text-align: center;">11*</td> <td style="text-align: center;">EVC₁</td> </tr> <tr> <td colspan="2">Use of other EVCs or CE-VLAN IDs is permitted provided that the configuration of the CE-VLAN ID/EVC Map conforms to MEF 10.1</td> </tr> <tr> <td colspan="2">The CE-VLAN ID for untagged and priority tagged Service Frames is configured to 11</td> </tr> </tbody> </table>	UNI ‘A’		CE-VLAN ID	EVC	11*	EVC ₁	Use of other EVCs or CE-VLAN IDs is permitted provided that the configuration of the CE-VLAN ID/EVC Map conforms to MEF 10.1		The CE-VLAN ID for untagged and priority tagged Service Frames is configured to 11																					
UNI ‘A’																															
CE-VLAN ID	EVC																														
11*	EVC ₁																														
Use of other EVCs or CE-VLAN IDs is permitted provided that the configuration of the CE-VLAN ID/EVC Map conforms to MEF 10.1																															
The CE-VLAN ID for untagged and priority tagged Service Frames is configured to 11																															
Bandwidth Profile	<table border="1" style="width: 100%; border-collapse: collapse;"> <thead> <tr> <th colspan="5" style="text-align: center;">PER INGRESS UNI</th> </tr> <tr> <th style="text-align: center;">UNI</th> <th colspan="4" style="text-align: center;">Bandwidth Profile Parameters</th> </tr> <tr> <th style="text-align: center;">UNI</th> <th style="text-align: center;">CIR</th> <th style="text-align: center;">CBS</th> <th style="text-align: center;">EIR</th> <th style="text-align: center;">EBS</th> </tr> </thead> <tbody> <tr> <td colspan="5">Note 1: (0 < CIR < Ingress UNI Speed), (CBS ≥ maximum Service Frame size)</td> </tr> <tr> <td colspan="5">Note 2: (Ingress CIR ≤ Egress UNI Speed)</td> </tr> <tr> <td colspan="5">Note 3: (EIR ≥ 0) and (EBS ≥ 0)</td> </tr> </tbody> </table>	PER INGRESS UNI					UNI	Bandwidth Profile Parameters				UNI	CIR	CBS	EIR	EBS	Note 1: (0 < CIR < Ingress UNI Speed), (CBS ≥ maximum Service Frame size)					Note 2: (Ingress CIR ≤ Egress UNI Speed)					Note 3: (EIR ≥ 0) and (EBS ≥ 0)				
PER INGRESS UNI																															
UNI	Bandwidth Profile Parameters																														
UNI	CIR	CBS	EIR	EBS																											
Note 1: (0 < CIR < Ingress UNI Speed), (CBS ≥ maximum Service Frame size)																															
Note 2: (Ingress CIR ≤ Egress UNI Speed)																															
Note 3: (EIR ≥ 0) and (EBS ≥ 0)																															
Test Procedure	Restart the UNI “A” MEN Side, use the tester 2 to send STATUS ENQUIRY messages and use the tester 1 to monitor the E-LMI messages for a period of time ($T = 5 \times T391$). After the first Full Status procedure is complete, add a new EVC in the UNI “A” MEN Side (UNI-N) and verify that the “New” bit in the EVC Status Information Element of the STATUS messages transmitted by the UNI “A” MEN Side (UNI-N) is set to 1 until the DI in the STATUS ENQUIRY messages received by the UNI-N is equal to the DI sent by the UNI-N in the messages in which the “New” bit was set to 1																														
Units	Data Instance and “New” bit in the EVC Status Information Element values																														
Variables	None																														
Results	Pass or fail																														
Remarks	Test Case must be run using T391 in the range (5-30 seconds) and N391 in the range (1-65k). Suggested values for T391 = 5 and N391 = 2.																														

TEST CASE 63N: Modification of an EVC Attribute “New” Bit Set to 0

Abstract Test Suite for E-LMI - Procedures									
Test Name	Modification of an EVC Attribute “New” Bit Set to 0								
Test Definition ID	UNIN-ELMI-5.6.8-R18								
Reference Document	MEF 20 UNI Type 2 Implementation Agreement Section 9 MEF 16 Ethernet Local Management Interface								
Test Type	Conformance								
Test Status	Mandatory								
Requirement Description	When an existing EVC attribute (e.g., Bandwidth profile) is changed, UNI-N SHALL set the “New” bit of the EVC Status Information Element to 0								
Test Object	Verify that when an existing EVC attribute (e.g., Bandwidth profile) is changed, UNI-N sets the “New” bit of the EVC Status Information Element to 0								
Test Configuration	At least two EVCs are configured on the UNI “A” MEN Side (UNI-N) and at least one CE-VLAN ID is mapped to each EVC. Per EVC bandwidth profiles are applied at the UNI “A”. Configure UNI “A” CE Side with the default value of N393. Configure UNI “A” MEN Side with the default values of N393 and T392. Tester 1 with proper PHYs that match the UNI “A” MEN side and CE side is monitoring the E-LMI frames								
Test Configuration Schematic									
CE-VLAN ID/EVC Map	<table border="1" style="width: 100%; border-collapse: collapse;"> <thead> <tr> <th colspan="2" style="text-align: center;">UNI ‘A’</th> </tr> <tr> <th style="text-align: center;">CE-VLAN ID</th> <th style="text-align: center;">EVC</th> </tr> </thead> <tbody> <tr> <td style="text-align: center;">11*</td> <td style="text-align: center;">EVC₁</td> </tr> <tr> <td style="text-align: center;">12</td> <td style="text-align: center;">EVC₂</td> </tr> </tbody> </table> <p>Use of other EVCs or CE-VLAN IDs is permitted provided that the configuration of the CE-VLAN ID/EVC Map conforms to MEF 10.1</p> <p>The CE-VLAN ID for untagged and priority tagged Service Frames is configured to 11</p>	UNI ‘A’		CE-VLAN ID	EVC	11*	EVC ₁	12	EVC ₂
UNI ‘A’									
CE-VLAN ID	EVC								
11*	EVC ₁								
12	EVC ₂								
Bandwidth Profile	<table border="1" style="width: 100%; border-collapse: collapse;"> <thead> <tr> <th colspan="2" style="text-align: center;">PER EVC</th> </tr> <tr> <th style="text-align: center;">EVC</th> <th style="text-align: center;">Bandwidth Profile Parameters</th> </tr> </thead> <tbody> <tr> <td style="text-align: center;">EVC₁</td> <td style="text-align: center;">CIR₁ CBS₁ EIR₁ EBS₁</td> </tr> <tr> <td style="text-align: center;">EVC₂</td> <td style="text-align: center;">CIR₂ CBS₂ EIR₂ EBS₂</td> </tr> </tbody> </table> <p>Note 1: (Σ Ingress CIRs \leq Ingress UNI Speed) Note 1: (CBS₁ \geq maximum Service Frame size), (CBS₂ \geq maximum Service Frame size) Note 3: (EIR₁ = 0), (EBS₁ = 0), (EIR₂ = 0) and (EBS₂ = 0)</p>	PER EVC		EVC	Bandwidth Profile Parameters	EVC ₁	CIR ₁ CBS ₁ EIR ₁ EBS ₁	EVC ₂	CIR ₂ CBS ₂ EIR ₂ EBS ₂
PER EVC									
EVC	Bandwidth Profile Parameters								
EVC ₁	CIR ₁ CBS ₁ EIR ₁ EBS ₁								
EVC ₂	CIR ₂ CBS ₂ EIR ₂ EBS ₂								
Test Procedure	Restart the UNI “A” MEN Side, use the tester 2 to send STATUS ENQUIRY messages and use the tester 1 to monitor the E-LMI messages for a period of time ($T = 2 \times N391 \times T391$). After the first Full Status procedure is complete, modify the bandwidth profile parameters of EVC ₁ in the UNI “A” MEN Side (UNI-N) and verify that the “New” bit of the EVC Status Information Element related to EVC ₁ of the next <i>Full Status</i> STATUS message transmitted by the UNI “A” MEN Side after the modification is set to 0								
Units	“New” bit of the EVC Status Information Element value								
Variables	None								
Results	Pass or fail								
Remarks	Test Case must be run using T391 in the range (5-30 seconds) and N391 in the range (1-65k). Suggested values for T391 = 5 and N391 = 2.								

13.4 E-LMI Impairments

TEST CASE 66N: Invalid Receive Sequence Number

Abstract Test Suite for E-LMI - Impairments	
Test Name	Invalid Receive Sequence Number
Test Definition ID	UNIN-ELMI-5.6.3-7-R18
Reference Document	MEF 20 UNI Type 2 Implementation Agreement Section 9 MEF 16 Ethernet Local Management Interface
Test Type	Conformance
Test Status	Mandatory. Test is possible only if the PVT is accessible
Requirement Description	When the UNI-N receives a STATUS ENQUIRY from the UNI-C, the UNI-N SHALL check the receive sequence number received from the UNI-C against its send sequence counter. If the values do not match, an error condition SHALL exist and the UNI-N SHALL reply with the requested Report Type and restart the Polling Verification Timer
Test Object	Verify that when the UNI-N receives a STATUS ENQUIRY from the UNI-C, it checks the receive sequence number received from the UNI-C against its send sequence counter and if the values do not match, an error condition exists and the UNI-N replies with the requested Report Type and restarts the Polling Verification Timer
Test Configuration	Configure UNI "A" CE Side with the default value of N393. Configure UNI "A" MEN Side with the default values of N393 and T392. Tester 1 with proper PHYs that match the UNI "A" MEN side and CE side is monitoring the E-LMI frames
Test Configuration Schematic	<pre> graph LR A[UNI 'A' MEN Side] --- B[Monitor Mode] B --- C[UNI 'A' CE Side] subgraph Testers B --- T1[Tester 1] C --- T2[Tester 2 (Impairment Generator)] end </pre>
CE-VLAN ID/EVC Map	Not Specified
Bandwidth Profile	Not Specified
Test Procedure	Restart the UNI "A" MEN Side, use the tester 2 to send STATUS ENQUIRY messages and use the tester 1 to monitor the E-LMI messages for a period of time ($T = 3 \times T391$). After the first Full Status procedure is complete, use the tester 2 to send a STATUS ENQUIRY message with an incorrect receive sequence number and verify that the UNI "A" MEN Side (UNI-N) replies with the requested Report Type and that the PVT is restarted
Units	STATUS message Report Type and PVT value
Variables	None
Results	Pass or fail
Remarks	Test Case must be run using T391 in the range (5-30 seconds) and N391 in the range (1-65k). Suggested values for T391 = 5 and N391 = 2.

TEST CASE 71N: Failure to Receive a STATUS ENQUIRY

Abstract Test Suite for E-LMI - Impairments	
Test Name	Failure to Receive a STATUS ENQUIRY
Test Definition ID	UNIN-ELMI-5.6.9.1-R18
Reference Document	MEF 20 UNI Type 2 Implementation Agreement Section 9 MEF 16 Ethernet Local Management Interface
Test Type	Conformance
Test Status	Mandatory if the PVT and error indication are accessible
Requirement Description	When the Polling Verification Timer is enabled, failure to receive a STATUS ENQUIRY within the Polling Verification Timer interval (T392) is an error and the UNI-N SHALL restart the Polling Verification Timer (T392)
Test Object	Verify that when the Polling Verification Timer is enabled, failure to receive a STATUS ENQUIRY within the Polling Verification Timer interval (T392) is an error and the UNI-N restarts the Polling Verification Timer (T392)
Test Configuration	Configure UNI "A" CE Side with the default value of N393. Configure UNI "A" MEN Side with the default values of N393 and T392. Tester 1 with proper PHYs that match the UNI "A" MEN side and CE side is monitoring the E-LMI frames
Test Configuration Schematic	<pre> graph LR A[UNI 'A' MEN Side] --- B[Monitor Mode] B --- C[UNI 'A' CE Side] </pre> <p style="text-align: center;"> UNI-N Under Test Tester 1 Tester 2 (Impairment Generator) </p>
CE-VLAN ID/EVC Map	Not Specified
Bandwidth Profile	Not Specified
Test Procedure	Restart the UNI "A" MEN Side, use the tester 2 to send only one STATUS ENQUIRY message and use the tester 1 to monitor the E-LMI messages for a period of time ($T = 1.5 \times T392$). If the PVT is accessible verify that it has restarted and if error indication is accessible, verify that an error was indicated.
Units	PVT value
Variables	None
Results	Pass or fail
Remarks	Test Case must be run using T391 in the range (5-30 seconds) and N391 in the range (1-65k). Suggested values for T391 = 5 and N391 = 2.

TEST CASE 82N: Protocol Version Error

Abstract Test Suite for E-LMI - Impairments	
Test Name	Protocol Version Error
Test Definition ID	UNIN-ELMI-5.6.10.1-R18
Reference Document	MEF 20 UNI Type 2 Implementation Agreement Section 9 MEF 16 Ethernet Local Management Interface
Test Type	Conformance
Test Status	Mandatory
Requirement Description	When a message is received with a protocol version coded other than (0000 0001), the message SHALL be ignored
Test Object	Verify that when a message is received with a protocol version coded other than (0000 0001), the message is ignored
Test Configuration	Configure UNI "A" CE Side with the default value of N393. Configure UNI "A" MEN Side with the default values of N393 and T392. Tester 1 with proper PHYs that match the UNI "A" MEN side and CE side is monitoring the E-LMI frames
Test Configuration Schematic	
CE-VLAN ID/EVC Map	Not Specified
Bandwidth Profile	Not Specified
Test Procedure	Restart the UNI "A" MEN Side, use the tester 2 to send STATUS ENQUIRY messages with protocol version coded other than 0000 0001 (for example 0000 0011) and use the tester 1 to monitor the E-LMI messages for a period of time ($T = 3 \times T391$). Verify that the UNI-N does not respond to any of the STATUS ENQUIRY messages with protocol version coded other than (0000 0001) and therefore that the received messages with protocol version error are ignored
Units	Number of STATUS messages
Variables	Protocol Version value
Results	Pass or fail
Remarks	Test Case must be run using T391 in the range (5-30 seconds) and N391 in the range (1-65k). Suggested values for T391 = 5 and N391 = 2.

TEST CASE 83N: Message Too Short

Abstract Test Suite for E-LMI - Impairments	
Test Name	Message Too Short
Test Definition ID	UNIN-ELMI-5.6.10.2-R18
Reference Document	MEF 20 UNI Type 2 Implementation Agreement Section 9 MEF 16 Ethernet Local Management Interface
Test Type	Conformance
Test Status	Mandatory
Requirement Description	When a message received is too short to contain a complete message type Information Element, that message SHALL be ignored
Test Object	Verify that when a message received is too short to contain a complete message type Information Element, that message is ignored
Test Configuration	Configure UNI "A" CE Side with the default value of N393. Configure UNI "A" MEN Side with the default values of N393 and T392. Tester 1 with proper PHYs that match the UNI "A" MEN side and CE side is monitoring the E-LMI frames
Test Configuration Schematic	
CE-VLAN ID/EVC Map	Not Specified
Bandwidth Profile	Not Specified
Test Procedure	Restart the UNI "A" MEN Side, use the tester 2 to send STATUS ENQUIRY messages too short to contain the complete message type Information Element and use the tester 1 to monitor the E-LMI messages for a period of time ($T = 3 \times T391$). Verify that the UNI-N does not respond to any of the STATUS ENQUIRY messages too short to contain the complete message type Information Element and therefore that the received messages too short to contain the complete message type Information Element are ignored
Units	Number of STATUS messages
Variables	None
Results	Pass or fail
Remarks	Test Case must be run using T391 in the range (5-30 seconds) and N391 in the range (1-65k). Suggested values for T391 = 5 and N391 = 2.

TEST CASE 84N: Message Type Errors

Abstract Test Suite for E-LMI - Impairments	
Test Name	Message Type Errors
Test Definition ID	UNIN-ELMI-5.6.10.3-R18
Reference Document	MEF 20 UNI Type 2 Implementation Agreement Section 9 MEF 16 Ethernet Local Management Interface
Test Type	Conformance
Test Status	Mandatory
Requirement Description	When an E-LMI message is received that specifies a message type which is not recognized, the E-LMI message SHALL be ignored
Test Object	Verify that when an E-LMI message is received that specifies a message type which is not recognized, the E-LMI message is ignored
Test Configuration	Configure UNI "A" CE Side with the default value of N393. Configure UNI "A" MEN Side with the default values of N393 and T392. Tester 1 with proper PHYs that match the UNI "A" MEN side and CE side is monitoring the E-LMI frames
Test Configuration Schematic	
CE-VLAN ID/EVC Map	Not Specified
Bandwidth Profile	Not Specified
Test Procedure	Restart the UNI "A" MEN Side, use the tester 2 to send STATUS ENQUIRY messages with a message type coding that is not defined (for example 01111111) and use the tester 1 to monitor the E-LMI messages for a period of time ($T = 3 \times T391$). Verify that the UNI-N does not respond to any of the STATUS ENQUIRY messages with a message type coding that is not defined and therefore that the received messages with a message type coding that is not defined are ignored
Units	Number of STATUS messages
Variables	Message Type value
Results	Pass or fail
Remarks	Test Case must be run using T391 in the range (5-30 seconds) and N391 in the range (1-65k). Suggested values for T391 = 5 and N391 = 2.

TEST CASE 86N: Duplicated Information Element

Abstract Test Suite for E-LMI - Impairments	
Test Name	Duplicated Information Element
Test Definition ID	UNIN-ELMI-5.6.10.4.2-R18
Reference Document	MEF 20 UNI Type 2 Implementation Agreement Section 9 MEF 16 Ethernet Local Management Interface
Test Type	Conformance
Test Status	Mandatory
Requirement Description	If an Information Element is duplicated in a message in which repetition is not permitted, only the contents of the first instance of the Information Element SHALL be considered and all subsequent instances SHALL be ignored
Test Object	Verify that if an Information Element is duplicated in a message in which repetition is not permitted, only the contents of the first instance of the Information Element is considered and all subsequent instances are ignored
Test Configuration	Configure UNI "A" CE Side with the default value of N393. Configure UNI "A" MEN Side with the default values of N393 and T392. Tester 1 with proper PHYs that match the UNI "A" MEN side and CE side is monitoring the E-LMI frames
Test Configuration Schematic	<pre> graph LR A[UNI 'A' MEN Side] --- B[Monitor Mode] B --- C[UNI 'A' CE Side] subgraph Labels D[UNI-N Under Test] --- E[Tester 1] --- F[Tester 2 (Impairment Generator)] end A --- D B --- E C --- F </pre>
CE-VLAN ID/EVC Map	Not Specified
Bandwidth Profile	Not Specified
Test Procedure	Restart the UNI "A" MEN Side and use tester 2 to send the first <i>Full Status</i> STATUS ENQUIRY message with two protocol version Information Elements; the first instance with a valid content (0000 0001) and the second instance coded other than (0000 0001) and a specific DI, Use the tester 1 to monitor the E-LMI messages for a period of time ($T = 3 \times T391$). Verify that the Report Type of the next STATUS message transmitted by the UNI "A" MEN Side (UNI-N) after the receipt of the STATUS ENQUIRY message with two protocol version Information Elements, is a <i>Full Status</i> STATUS message with a DI equal to the DI of the STATUS ENQUIRY message with two protocol version Information Elements confirming that the subsequent instance of the Protocol Version was ignored
Units	STATUS message Report Type and DI
Variables	None
Results	Pass or fail
Remarks	Test Case must be run using T391 in the range (5-30 seconds) and N391 in the range (1-65k). Suggested values for T391 = 5 and N391 = 2.

TEST CASE 89N: Unexpected Recognized Information Element

Abstract Test Suite for E-LMI - Impairments	
Test Name	Unexpected Recognized Information Element
Test Definition ID	UNIN-ELMI-5.6.10.4.5-R18
Reference Document	MEF 20 UNI Type 2 Implementation Agreement Section 9 MEF 16 Ethernet Local Management Interface
Test Type	Conformance
Test Status	Mandatory
Requirement Description	When a STATUS ENQUIRY message is received with a recognized Information Element not defined to be contained in that message, the UNI-N SHALL treat the Information Element as an unrecognized Information Element and ignore it
Test Object	Verify that when a STATUS ENQUIRY message is received with a recognized Information Element not defined to be contained in that message, the UNI-N treats the Information Element as an unrecognized Information Element and ignores it
Test Configuration	Configure UNI "A" CE Side with the default values of N393. Configure UNI "A" MEN Side with the default values of N393 and T392. Tester 1 with proper PHYs that match the UNI "A" MEN side and CE side is monitoring the E-LMI frames
Test Configuration Schematic	
CE-VLAN ID/EVC Map	Not Specified
Bandwidth Profile	Not Specified
Test Procedure	Restart the UNI "A" MEN Side and use tester 2 to send the first <i>Full Status</i> STATUS ENQUIRY message with a UNI Status Information Element and a specific DI. Use the tester 1 to monitor the E-LMI messages for a period of time ($T = 3 \times T391$). Verify that the Report Type of the next STATUS message transmitted by the UNI "A" MEN Side (UNI-N) after the receipt of the STATUS ENQUIRY message with a UNI Status Information Element, is a <i>Full Status</i> STATUS message with a DI equal to the DI of the STATUS ENQUIRY message with a UNI Status Information Element confirming that the unrecognized Information Element was ignored
Units	STATUS message Report Type and DI
Variables	None
Results	Pass or fail
Remarks	Test Case must be run using T391 in the range (5-30 seconds) and N391 in the range (1-65k). Suggested values for T391 = 5 and N391 = 2.

TEST CASE 90N: Status Counter Configuration

Abstract Test Suite for E-LMI - Impairments	
Test Name	Status Counter Configuration
Test Definition ID	UNIN-ELMI-5.6.11.2-R23
Reference Document	MEF 20 UNI Type 2 Implementation Agreement Section 9 MEF 16 Ethernet Local Management Interface
Test Type	Conformance
Test Status	Optional. Test possible only if access to the UNI-N local database is possible*
Requirement Description	A UNI-N Type 2 SHOULD allow the configuration of the N393 Status Counter Parameter Threshold in the range from 2 to 10, with the default of 4
Test Object	Verify that a UNI-N Type 2 allows the configuration of the N393 Status Counter Parameter Threshold in the range from 2 to 10, with the default of 4
Test Configuration	Configure UNI "A" MEN Side with the default value of T392. Tester 1 with proper PHYs that match the UNI "A" MEN side and CE side is monitoring the E-LMI frames
Test Configuration Schematic	<pre> graph LR A[UNI 'A' MEN Side] --- B[Monitor Mode] B --- C[UNI 'A' CE Side] subgraph Labels D[UNI-N Under Test] --- B E[Tester 1] --- B F[Tester 2 (Impairment Generator)] --- C end </pre>
CE-VLAN ID/EVC Map	Not Specified
Bandwidth Profile	Not Specified
Test Procedure	Configure the N393 Status Counter Parameter Threshold with a value of 4. Restart the UNI "A" MEN Side, use the tester 2 to send at least four STATUS ENQUIRY message with a protocol version error (protocol version coded other than 0000 0001), to the UNI-N and use the tester 1 to monitor the E-LMI messages for a period of time ($T = 4 \times T391$). Verify that at this time, the UNI "A" MEN Side (UNI-N) reports that the E-LMI is not operational. Repeat the test with (N393 = 2) and ($T = 2 \times T391$). Repeat the test again with (N393 = 10) and ($T = 10 \times T391$)
Units	N393 Status counter value
Variables	N393
Results	Pass or fail
Remarks	Test Case must be run using T391 in the range (5-30 seconds) and N391 in the range (1-65k). Suggested values for T391 = 5 and N391 = 2 *There is no standard external signal indicating that the E-LMI is not operational

TEST CASE 91N: Polling Verification Timer

Abstract Test Suite for E-LMI - Impairments	
Test Name	Polling Verification Timer
Test Definition ID	UNIN-ELMI-5.6.1-f
Reference Document	MEF 20 UNI Type 2 Implementation Agreement Section 9 MEF 16 Ethernet Local Management Interface
Test Type	Conformance
Test Status	Optional. Test possible only if the PVT is accessible
Requirement Description	A UNI-N Type 2 SHOULD allow the configuration of the T392 Polling Verification Timer Threshold in the range from 5 to 30, with the default of 15
Test Object	Verify that a UNI-N Type 2 allows the configuration of the T392 Polling Verification Timer Threshold in the range from 5 to 30, with the default of 15
Test Configuration	Configure UNI "A" CE Side with the default value of N393. Configure UNI "A" MEN Side with the default value of N393. Tester 1 with proper PHYs that match the UNI "A" MEN side and CE side is monitoring the E-LMI frames
Test Configuration Schematic	
CE-VLAN ID/EVC Map	Not Specified
Bandwidth Profile	Not Specified
Test Procedure	Configure the T392 Polling Verification Timer Threshold with a value of 15. Restart the UNI "A" MEN Side, use the tester 2 to send four STATUS ENQUIRY message to the UNI-N and use the tester 1 to monitor the E-LMI messages for a period of time ($T = 4 \times T391$). Verify that at this time, the UNI "A" MEN Side (UNI-N) reports that the PVT has restarted 4 times. Repeat the test with ($T392 = 5$). Repeat the test again with ($T392 = 30$)
Units	PVT state
Variables	T392
Results	Pass or fail
Remarks	Test Case must be run using T391 in the range (5-30 seconds) and N391 in the range (1-65k). Suggested values for T391 = 5 and N391 = 2

TEST CASE 92N: Polling Verification Timer Disabled

Abstract Test Suite for E-LMI - Impairments	
Test Name	Polling Verification Timer
Test Definition ID	UNIN-ELMI-5.6.1-R24
Reference Document	MEF 20 UNI Type 2 Implementation Agreement Section 9 MEF 16 Ethernet Local Management Interface
Test Type	Conformance
Test Status	Optional Test possible only if the PVT is accessible
Requirement Description	A UNI-N Type 2 SHOULD allow disabling the Polling Verification Timer. If it is disabled, the PVT never expires
Test Object	Verify that a UNI-N Type 2 allows disabling the Polling Verification Timer and if it is disabled, it never expires
Test Configuration	Configure UNI "A" CE Side with the default value of N393. Configure UNI "A" MEN Side with the default values of T392 and N393. Tester 1 with proper PHYs that match the UNI "A" MEN side and CE side is monitoring the E-LMI frames
Test Configuration Schematic	<pre> graph LR A[UNI 'A' MEN Side] --- B[Monitor Mode] B --- C[UNI 'A' CE Side] subgraph Labels D[UNI-N Under Test] --- E[Tester 1] --- F[Tester 2 (Impairment Generator)] end A --- D B --- E C --- F </pre>
CE-VLAN ID/EVC Map	Not Specified
Bandwidth Profile	Not Specified
Test Procedure	Restart the UNI "A" MEN Side, use the tester 2 to send only one STATUS ENQUIRY message and use the tester 1 to monitor the E-LMI messages for a period of time ($T = 1.5 \times T392$). If the PVT is accessible verify it has not expired
Units	PVT state
Variables	None
Results	Pass or fail
Remarks	Test Case must be run using T391 in the range (5-30 seconds) and N391 in the range (1-65k). Suggested values for T391 = 5 and N391 = 2

14. References

References	Details
[1] UNI IA Type 2	MEF 20 [UNI Type 2 Implementation Agreement]
[2] Abstract Test Suite for Ethernet Services at the UNI	MEF 9 [Abstract Test Suite for Ethernet Services at the UNI]
[3] Abstract Test Suite for Traffic Management	MEF 14 [Abstract Test Suite for Traffic Management]
[4] E-LMI	MEF 16 [Ethernet Local Management Interface]
[5] RFC 2119	RFC 2119, "Key words for use in RFCs to Indicate Requirement Levels", S. Bradner, http://www.ietf.org/rfc/rfc2119.txt (Normative)
[6] RFC 2285	RFC 2285, "Benchmarking Terminology for LAN Switching Devices", R. Mandeville, http://www.ietf.org/rfc/rfc2285.txt
[7] RFC 2544	RFC 2544, "Benchmarking Methodology for Network Interconnect Devices", S. Bradner, J. McQuaid, http://www.ietf.org/rfc/rfc2544.txt
[8] RFC 2889	RFC 2889, "Benchmarking Methodology for LAN Switching Devices", R. Mandeville, J. Perser, http://www.ietf.org/rfc/rfc2889.txt